



RIGA TECHNICAL  
UNIVERSITY

**Otto Krickis**

**COMBUSTION CONTROL METHODOLOGY  
FOR GASEOUS FUELS IN INTENSE  
ELECTROSTATIC FIELD CONDITIONS**

Summary of the Doctoral Thesis



RTU Press  
Riga 2019

**RIGA TECHNICAL UNIVERSITY**  
Faculty of Mechanical Engineering, Transport and Aeronautics  
Institute of Mechanics and Mechanical Engineering

**Otto Krickis**

Doctoral Student of the Study Programme “Engineering Technology, Mechanics and  
Mechanical Engineering”

**COMBUSTION CONTROL METHODOLOGY  
FOR GASEOUS FUELS IN INTENSE  
ELECTROSTATIC FIELD CONDITIONS**

**Summary of the Doctoral Thesis**

Scientific Supervisor  
Professor Dr. habil. sc. ing.  
NAMEJS ZELTIŅŠ

Associate Professor Dr. sc. ing.  
SIGURDS JAUNDĀLDERS

RTU Press  
Riga 2019

Krickis, O. Combustion Control Methodology for Gaseous Fuels in Intense Electrostatic Field Conditions. Summary of the Doctoral Thesis. Riga: RTU Press, 2019. 30 p.

Printed in accordance with the decision of Promotional Council "RTU P-12" of May 17, 2019, Minutes No.1/19.

**ISBN 978-9934-22-321-1 (print)**  
**978-9934-22-322-8 (pdf)**

# **DOCTORAL THESIS PROPOSED TO RIGA TECHNICAL UNIVERSITY FOR THE PROMOTION TO THE SCIENTIFIC DEGREE OF DOCTOR OF ENGINEERING SCIENCES**

To be granted the scientific degree of Doctor of Engineering Sciences, the present Doctoral Thesis has been submitted for the defence at the open meeting of RTU Promotion Council on 18 October 2019 12:00 at the Faculty of Civil Engineering of Riga Technical University, 6 Kipsalas Street, Room .....

## **OFFICIAL REVIEWERS**

Professor Dr. habil. sc .ing. Egils Dzelzīts  
Riga Technical University

Leading research scientist Dr. sc. ing. Gaidis Klāvs  
Institute of Physical Energetics, Latvia

Chief executive officer Dr. sc.ing. Normunds Talcis  
JSC “Rīgas Siltums”, Latvia

## **DECLARATION OF ACADEMIC INTEGRITY**

I hereby declare that the Doctoral Thesis submitted for the review to Riga Technical University for the promotion to the scientific degree of Doctor of Engineering Sciences is my own. I confirm that this Doctoral Thesis had not been submitted to any other university for the promotion to a scientific degree.

Otto Krickis ..... (signature)

Date: .....

The Doctoral Thesis is written in Latvian. It consists of an introduction; 4 chapters; conclusions; 52 figures, 13 tables; the total number of pages is 111. The Bibliography contains 112 titles.

## ANNOTATION

The Doctoral Thesis “Combustion Control Methodology for Gaseous Fuels in Intense Electrostatic Field” is devoted to control of the combustion process of gaseous fuel and flue gas emission in application of intense electrostatic field, as well as to the research of the flame thermo-acoustic effect.

The focus of the promotion work is on the need to develop technical methods to reduce both the costs of maintenance of combustion plants and greenhouse gas emissions in the atmosphere, as well as to increase the efficiency of energy consumable technologies.

The goal of the Thesis is the development of a methodology for the control of combustion and harmful emissions formation of premixed gaseous fuels in an intensive electrostatic field. It provides the development of a set of techniques and methods, which allow to prove an impact of intensive electrostatic fields on geometrical shape of flame and on emissions such as CO, NO<sub>x</sub> and CO<sub>2</sub>, as well as ensure the control of flue gas temperatures and better combustion of fuel and primary energy savings.

The Doctoral Thesis consists of an introduction, theoretical and analytical part, and methodology – description of the equipment used in the research and its technical characteristics, as well as experimental design and data processing methods.

The first chapter (theoretical and analytical assessment of fuel combustion in external field conditions) describes the effect of the use of electrostatic, magnetic and electromagnetic fields on the combustion of fuel, covering a detailed ionization process and ion flow theory.

The second chapter (methodology for a gaseous fuel combustion research under electrostatic field conditions) provides indicators for the main components of the equipment used, a description of their design, and the development and adjustment process. An expansion of the research methodology and experiment design, the methods used and the procedures for collecting data and data processing algorithms are provided, as well as facts about the used data processing programs.

The third chapter (results of a gaseous fuel combustion research under electrostatic field conditions) includes results of the single-factor and multivariate experiments using both DC and pulsating current sources. The effects of an intense electrostatic field impact on the concentrations of emissions, changes in flame geometric shape and flue gas temperature were analysed, and the effects of the electrostatic field impact on the thermal-acoustic effect of the flame were evaluated analytically. This chapter summarizes graphic results and empirical regression equations of the observed correlations.

The fourth chapter (techno-economic assessment of the use of an intensive electrostatic field) analyses the technical-economic assessment of the results of research. The developed methods in the framework of this research make it possible to reduce the costs of maintenance repairs of heavy-power combustion plants installed in Latvia. Including the costs of technological integration, savings of up to EUR 550 000 over a fifteen-year period can be achieved, in addition ensuring the reduction of greenhouse gas emissions and the savings of primary energy sources.

# CONTENTS

CONTENTS .....	5
INTRODUCTION.....	6
1. THEORETICAL AND ANALYTICAL ASSESSMENT OF FUEL COMBUSTION IN EXTERNAL FIELD CONDITIONS .....	10
1.1. Influence of Electrostatic Field on the Combustion Process.....	10
1.2. Ionization Process.....	10
1.3. Ion Flow.....	11
1.4. Effect of Electrostatic Field on Harmful Emissions.....	11
1.5. Thermo-Acoustic Effect .....	12
2. METHODOLOGY FOR A GASEOUS FUEL COMBUSTION RESEARCH UNDER ELECTROSTATIC FIELD CONDITIONS .....	13
2.1. Research Methodology .....	14
2.2. Experimental Equipment .....	15
2.3. Analytical Assessment of the Combustion Process.....	18
2.4. Thermo-Acoustic Signal Assessment.....	19
3. RESULTS OF A GASEOUS FUEL COMBUSTION RESEARCH UNDER ELECTROSTATIC FIELD CONDITIONS .....	20
3.1. First Stage of the Research .....	20
3.2. Second Stage of the Research.....	22
3.3. Third Stage of the Research.....	27
4. TECHNO-ECONOMIC ASSESSMENT OF THE USE OF AN INTENSIVE ELECTROSTATIC FIELD.....	29
CONCLUSIONS .....	30

# INTRODUCTION

## Topicality of Research

In the light of the studies carried out so far and global conclusions of scientists about climate change, a number of international, EU and Latvian legislative acts have been developed, which regulate greenhouse gas emissions in the atmosphere and thus determine the current nature of this Doctoral Thesis.

- The 2015 Paris Agreement on climate change aims to reduce greenhouse gas emissions in the atmosphere. This agreement requires Member States to reduce greenhouse gas emissions by at least 40 % by 2030 compared to 1990.
- Directive 2012/27/EU of the European Parliament and of the Council on energy efficiency is put forward for increased efficiency in energy consumable technologies.
- The European Parliament Resolution of 13 September 2016 with guidelines on the European Union strategy for heating and cooling (2016/2058 (INI)).
- Directive 2008/50/EC of the European Parliament and of the Council on ambient air quality and cleaner air for Europe, which must be respected throughout the European Union in order to ensure overall protection against harmful levels of air pollution.
- Directive 2010/75/EU of the European Parliament and of the Council on industrial emissions (integrated pollution prevention and control) contains provisions for the reduction of emissions to air, water and land in order to achieve a high level of environmental protection in general.;
- In accordance with Commission Implementing Decision (EU) 2017/1442 and Directive 2010/75/EU of the European Parliament and of the Council, conclusions are adopted on best available techniques (BAT) for large combustion plants.;
- The Latvian State Law on Pollution, which defines that in order to reduce the negative impacts of air pollution on human health and the environment, Latvia should reduce emissions of sulphur dioxide, nitrogen oxide and volatile organic compounds from different sectors of the economy between 2020 and 2029 and after 2030.

Taking into account the need to ensure national energy independence with the possibility of fuel diversification or the substitution of different types of fuels with equivalent properties, it is particularly important to find technologies for efficient and environmentally friendly use of replacement fuels and to develop technologies that enable more economically efficient operation of combustion plants. One of such technological solutions is external field application, which according to the performed studies allows to achieve high performance indicators in the flame stabilization and in the harmful emissions concentration reduction of combustion processes. A number of studies have been carried out on this subject in the United Kingdom (Dr. James Wienberg), France (Ph.D Memdouh Belhi, PhD Pascale Domingo), Spain (PhD Mario Sánchez-Sanz), the USA (PhD S.D. Marcum, PhD B.N. Ganguly, PhD Sunny Karnani, PhD Aaron M. Drews), Israel (PhD Alexander B. Fialkov), Netherlands (PhD J. D. B. J. van den Boom, PhD A. M. H. H. Verhasselt, PhD E.N.Volkov), China (PhD Y. Wang), Saudi Arabia (PhD Fabrizio Bisetti, PhD Dae Geun Park, PhD Suk Ho Chung, PhD Min Suk

Cha, PhD M.K.Kim). The performed studies are dedicated to the analysis of the effects of mean intensity ( $\approx 150$  kV/m) electrostatic field impact on fuel combustion. No studies have been performed on the effects of an intensive ( $\geq 1000$  kV/m) electrostatic field on the combustion process with internal electrodes integrated in the burner. The studies cover neither the effects of the electrostatic field impact in a combination with the variation in oxidizer composition on the stability of combustion nor the application of intensive electrostatic field to reduce the costs of maintenance for high-power heat only boiler houses. Aspects of fuel combustion under the influence of external fields in Latvia have been studied by Dr. habil. sc. ing. Namejs Zeltiņš, Dr. habil. sc. ing. Daniels Turlajs, Dr. phys. Maija Zaķe, Dr. sc. ing. Inesa Barmina, Dr. sc. ing. Agnese Līckrastiņa, Dr. sc. ing. Sergejs Vostrikovs, Raimonds Valdmanis and Modris Purmalis.

### **Goal of the Thesis**

The goal of the Thesis is to develop a methodology for the control of combustion and harmful emissions formation of premixed gaseous fuels in an intensive electrostatic field. It provides the development of a set of techniques and methods, which allow to prove an impact of intensive electrostatic fields on geometric shape of flame and emissions, such as CO, NO<sub>x</sub> and CO<sub>2</sub>, as well as ensure the control of flue gas temperatures and better combustion of fuel and primary energy savings.

Since more than half of all Latvian energy resources are consumed for heating and hot water supply, it is important to analyse energy consumption and the possibilities of reducing harmful emissions related to energy production. This Doctoral Thesis is devoted to an in-depth study of the combustion process under the influence of an electrostatic field by conducting laboratory experiments with full-scale equipment that excludes the effects of the surrounding environment on the subject. In this Thesis, experimental studies have been divided into three stages with each stage involving the use of constructively different experimental equipment with the aim to determine the impact of electrode placement and electrostatic field intensity as well as of other factors on important parameters of the combustion process, such as changes of the flame geometrical shape, CO, CO<sub>2</sub>, NO<sub>x</sub> harmful emissions in the flue gas, flue gas temperature, etc. In addition, detailed results of the study of the electrostatic field influence on the thermal-acoustic effect of the flame have been provided in this Thesis.

### **Scientific Novelty of the Thesis**

The author's contribution is as follows:

- methodology for an intensive electrostatic field generation using integrated electrodes in the burner has been developed and validated;
- an intensive electrostatic field impact on the volatile substances (CO, CO<sub>2</sub>, NO<sub>x</sub>) concentration in the flue gas, the flame shape and the flue gas temperature changes has been explored;
- the effect of an intensive electrostatic field on the flame thermo-acoustic signal of LPG (with propane molar fraction – 0.92) has been studied.



## Practical Importance of the Thesis

The methodology developed in the context of the Thesis can be used in the development of new technologies and in modernization of existing installations, thereby ensuring high competitiveness of energy as a sector of the national economy in the long-term. The developed methodology makes it possible to achieve a stabilization of the gaseous fuel flame, a reduction in flame length and a lower concentration of volatile substances (CO, CO<sub>2</sub>, NO<sub>x</sub>) in the flue gases. The achieved results, the developed and approved equipment provide an opportunity for the successful integration of this technology into full-scale combustion plants, ensuring greater competitiveness, lower operating and maintenance costs, primary energy savings and lower costs to cover CO<sub>2</sub> emissions allowances.

The results of the research can be used in the project of the Ministry of Economics of the Republic of Latvia, “Trends, Challenges and Solutions of Latvian Gas Infrastructure Development (LAGAS)”. Project No. VPP-EM-INFRA-2018/1-0003.

## Author’s Scientific Publications

1. Krickis, O., Zeltiņš, N. Gas Combustion Efficiency Enhancement: Application Study of Intense Electrostatic Field. *Latvian Journal of Physics and Technical Sciences*. 2019, issue 4. p. 16.
2. Krickis, O., Jaundālders, S. DC Electrical Field Impact on Propane Combustion By-Products and Acoustic Effect of The Flame. *IEEE 59th International Scientific Conference on Power and Electrical Engineering of Riga Technical University (RTUCON)*. 2018, pp. 1–7. Available from: doi: 10.1109/RTUCON.2018.8659832
3. Krickis, O. Effect of Electric Field in the Stabilized Premixed Flame on Combustion Process Emissions. *In: IOP Conference Series: Materials Science and Engineering. IOP Publishing*. 2017, vol. 251, pp. 1–5. Available from: doi: <https://doi.org/10.1088/1757-899X/251/1/012116>
4. Krickis, O., Jaundālders, S. Impact of electric field in the stabilized premixed flame on NO<sub>x</sub> and CO emissions. *In: Power and Electrical Engineering of Riga Technical University (RTUCON)*. 2017, pp. 1–5. Available from: doi: 10.1109/RTUCON.2017.8124799
5. Krickis, O., Oleksijs, R. Engineering approach for cost effective operation of industrial pump systems. *IOP Conference Series: Materials Science and Engineering, IOP Publishing*. 2017, vol. 251, pp. 121–129. Available from: doi: <https://doi.org/10.1088/1757-899X/251/1/012129>
6. Krickis, O., Oleksijs, R. Safe operation of the industrial centrifugal pump sets in parallel connection. *IEEE 58th International Scientific Conference on Power and Electrical Engineering of Riga Technical University (RTUCON)*. 2017, pp. 1–7. Available from: doi: <https://doi.org/10.1109/RTUCON.2017.8124774>

### **The Results of the Study Have Been Reported and Verified in the Following Conferences**

1. 2018 IEEE 59th International Scientific Conference on Power and Electrical Engineering of Riga Technical University, RTUCON 2018, 12–14 Nov., Riga, Latvia.
2. Riga Technical university 59th International Scientific Conference, 2018, 26 October Riga, Latvia.
3. Riga Technical university 58th International Scientific Conference, 2017, 26 October Riga, Latvia.
4. 2017 IEEE 58th International Scientific Conference on Power and Electrical Engineering of Riga Technical University, RTUCON 2017, 12–14 Oct. Riga, Latvia. (*Impact of electric field in the stabilized premixed flame on NO<sub>x</sub> and CO emissions*).
5. 2017 IEEE 58th International Scientific Conference on Power and Electrical Engineering of Riga Technical University, RTUCON 2017, 12–14 Oct. Riga, Latvia. (*Safe operation of the industrial centrifugal pump sets in parallel connection*).
6. 3rd International Conference on Innovative Materials, Structures and Technologies, IMST 2017, 27–29 Sept. Riga, Latvia. (*Effect of Electric Field in the Stabilized Premixed Flame on Combustion Process Emissions*).
7. 3rd International Conference on Innovative Materials, Structures and Technologies, IMST 2017, 27–29 September Riga, Latvia. (*Engineering approach for cost effective operation of industrial pump systems*)
8. Riga Technical university 57th International Scientific Conference, 2016, 20 October Riga, Latvia.

# 1. THEORETICAL AND ANALYTICAL ASSESSMENT OF FUEL COMBUSTION IN EXTERNAL FIELD CONDITIONS

## 1.1. Influence of Electrostatic Field on the Combustion Process

The stability of combustion and the improvement of the boundaries of combustion are the most pressing issues for improvement of modern combustion plants. The use of an electric field in the flame zone provides a solution that is simple in implementation and effective at the same time to change the flame structure, as well as the ability to control the concentration of harmful emissions formation in the flue gases.

The electric field influences the combustion of the flame in three ways: by the thermal effect associated with the conversion of electric energy into heat; by the ionic wind effect; and also by the electrically-chemical effect. The electrically-chemical effect produces fast electrons, radicals, ionic and induced molecules before the combustion zone, which in turn greatly affects the chemistry of the flame.

In the case of a pulsating current source, when the electric field frequency is low, ions and electrons have enough time to reach electrodes.

Charged particles may be accelerated under the influence of Lorentz force. This may result in three flame effects: 1) charged particle diffusion flux can be improved; 2) the pulse transition from the accelerated charged particles to the neutral molecules can generate large flows, which leads to the ionic-wind effect; 3) enhanced kinetic energy of charged particle can affect the thermo-chemical reaction rates.

## 1.2. Ionization Process

Combustion in lean fuel concentration mode is an effective method for reducing harmful emissions and fuel consumption. Several studies with premixed and diffusion flames, both with laminar and turbulent combustion, have shown the combustion improvement under the influence of an electric field (AC and DC) at low electricity consumption compared to the heat input in the combustion chamber. However, there are differences in the result, which make it difficult to identify the main physical phenomenon that contributes to improving of combustion stabilization.

There are a number of chemical ionization reactions that constitute flame ion chemistry. The two most important chemical ionization reactions (1.1, 1.2) are:

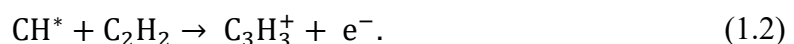

$\text{CH}_3\text{O}^+$  ion concentration in flame is 2 to 4 times lower comparing with  $\text{C}_3\text{H}_3^+$  ion. Ion  $\text{C}_3\text{H}_3^+$  is considered to be the main in ion mechanism of the soot formation process. In addition, it was noted that  $\text{CHO}^+$  is a primary ion in a reaction between an oxidizing atom and fuel before combustion process.

The following process times are differentiated in which the highly reactive ions are located in the flame frontal part: convective transition time ( $t_k$ ), diffusion time ( $t_d$ ), immersion time ( $t_{sf}$ ), transformation time ( $t_r$ ), the characteristic time (the time between ion transformations to the other ions in the ion–molecular reactions) ( $t_i$ ).

According to scientists' studies, in the reaction zone of the hydrocarbon flame, the chemical ionization process and subsequent reactions are associated with the positive ions of the charged particles ( $H_3O^+$ ,  $C_3H_3^+$ ,  $CH_3^+$ ,  $CHO^+$ ), the formation of negative ions ( $O_2^-$ ,  $OH^-$ ,  $O^-$ ,  $CHO_2^-$ ,  $CHO_3^-$ ,  $CO_3^-$ ), and electrons, which interact under the influence of Coulomb force resulting in their transformation and minimizing the local electrical potential in which they are located.

### 1.3. Ion Flow

Molecules such as  $O_2$ ,  $N_2$ ,  $H_2$  and equivalent molecules, which are called non-polar gases, do not have their own dipole moment. All other diatomic molecules consisting of different atoms (e.g.  $CO$ ,  $OH$ ) or molecules with an asymmetric geometric structure ( $H_2O$ ,  $C_6H_6$  and others) have their own dipole moment. Such molecules are called polar molecules. In an external electric field, both non-polar and polar molecules polarize and tend to settle along the formed external field lines.

Using an electric field ( $E$ ) to influence the combustion process, Lorentz's forces act on charged particles, causing them to accelerate. This calls the drift speed of directly directed charged particles. The positive ions move in the direction of the cathode (lower potential electrode) and repeat the lines of the electric field while the electrons and negative ions move in the opposite direction of the anode (higher potential electrode). This movement of charged particles into a hydrocarbon flame creates an electrical current.

In the reaction zone, the number of positive ions is greater in comparison to negative ions. Carriers of negative charge include negative ions and electrons, therefore the total number of negative charges should be equal to the number of positive charges. Positive charges are responsible for inertia transfer, resulting in a one-way ionic wind in the direction of the cathode.

In a low-frequency alternating electrical field, both positive and negative ions can lead to the ionic wind effect in both directions cathode and anode. Such a two-way ionic wind can produce a visible effect, which is reflected as a flow field in cases where the flow rate near the flame is less than the flow rate caused by ionic wind.

The induced ionic wind under the influence of the electric field can increase the speed of the blow around the flame and the AC electric field can promote heat exchange around the flame, thereby increasing the release of heat losses from the flame. As the temperature of the flame increases with the increase of intensity of the electric field, the fuel burns more intensively, which compensates heat losses from the flame.

### 1.4. Effect of Electrostatic Field on Harmful Emissions

In the full-scale test organized by Latvian researchers, the application of an electric field to the industrial boiler DKVR-10-13 was analysed, which resulted in an improvement of heat

output by 3.5–8.5 %, with an average increase in efficiency of the industrial boiler of 2.8 % at the simultaneous thermal NO<sub>x</sub> reduction in the range of 15–20 %.

Experimental results of swirled combustion using the electric field indicate that the transfer of the electric field's intensified mass of radial fuel promotes air/fuel mixing, the total combustion of the fuel, thereby increasing the flame temperature and combustion efficiency.

Studies on the effects of a direct current electric field on a propane-to-air flame showed a reduction in the flame temperature and CO<sub>2</sub> mass fraction.

Studies of the combustion process on the use of sinusoidal alternating electric fields with variable frequencies of up to 10 kHz show that, at a voltage of 1.0 kV, both CO and NO molar fractions reach a critical value, but at a voltage range of 1.0–3.0 kV, an opposite flame reaction is observed compared to low-voltage mode. At a voltage above 3.0 kV, the flame's yellow tone disappears, the molar fraction of CO rapidly increases and NO molar fraction decreases.

### **1.5. Thermo-Acoustic Effect**

The thermo-acoustic effect of the flame is one of the biggest problems for high-power combustion equipment. During their operation, self-generating oscillations of high amplitude, low-frequency pressure and heat release are observed. In fact, the combination of acoustic waves and heat sources modulates the oscillations of instantaneous heat release oscillations in the phase with pressure fluctuations, which in turn produce a resonant acoustic effect in the combustion chamber. According to experimental observations of researchers, a spectral analysis of pressure and heat distribution capacity may be used to test initiatives in unstable combustion systems. In the combustion experiments, it was found that the methane thermo-acoustic fundamental frequency is 120 Hz.

## 2. METHODOLOGY FOR A GASEOUS FUEL COMBUSTION RESEARCH UNDER ELECTROSTATIC FIELD CONDITIONS

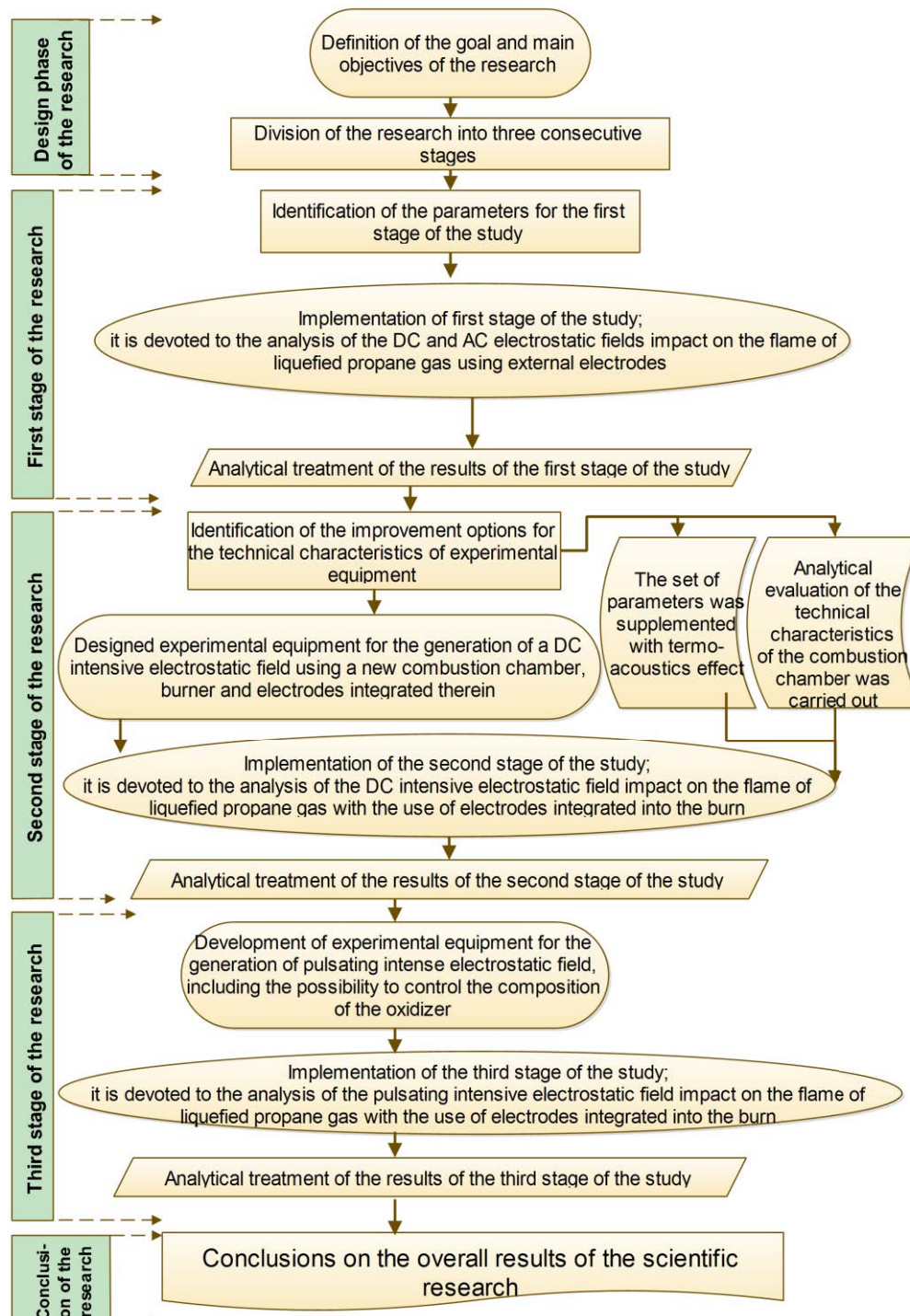

Fig. 2.1. Organisation scheme of the research.

In the framework of the current research, the investigational process was divided into three stages in order to identify the different types of equipment layout and electrostatic field impact on the combustion process parameters and flue gas composition changes, which depend on one

or more experimental factors. The organisation scheme of the research is presented in Fig. 2.1. It includes the planning phase of the study, three consecutive stages and the conclusion of the study. Each subsequent stage was based on the results of the previous stage of the study. The summary of all results gives detailed information about the research topic.

## 2.1. Research Methodology

The first stage of the research involved the construction of laboratory equipment (Fig. 2.2) composition of which corresponds to the conventional electric field application scheme securing electric field generation around a flame. For this task a copper tube (coil) with the inner cooling channel was used, which was connected to a high voltage source. In this stage of research the direct current electrostatic field impact on the propane combustion at voltage range 0–1800 V was analysed. Experiment design of the first stage of the research is based on the analysis of one-factor impact on a number of resulting responses. Eighteen factor levels were selected for this experiment. The voltage of the AC source of the DC network was selected as the main factor. This stage was divided into two blocks. The first block included five experiments with DC/AC electrostatic fields with voltage source from 29 V to 1800 V, whereas in the second block of the stage, two experiments were conducted in the DC voltage range from 29 V to 280 V. Voltage was taken as the main factor, while responses were O<sub>2</sub>, CO and NO<sub>x</sub> measurements from the gas analyser.

The second stage of the research was based on data gathered in the first stage of the study. These data were used for the reconstruction of an experimental equipment, including the design and construction of a new combustion chamber, the development of a new burner design, and a new electric field-generator – laboratory-type transformer with a smaller voltage adjustment step. All these parts were combined with a new step-up high-voltage transformer with a high-voltage multiplier that simultaneously performed the rectification function. The second stage was based on the determination of changes in the composition of the flue gas, depending on the voltage of the DC source used, which was applied to the hybrid burner. The factor to be controlled for this experiment was the DC voltage, while the response was the concentration and temperature values of the components of the flue gas, which in total constituted the seven parameters. The limits of the variable factor is the voltage range from 0 V to 2200 V. The second stage experiments were based on one factor variation at nine levels with manually performed distribution of levels.

In the framework of the third stage of the research analysis of flue gas composition and flue gas temperature change of LPG (propane molar fraction 0.92) combustion process depending on the three external variable factors was performed: 1 – pulsating current (voltage); 2 – pulsating current frequency (switching frequency); and 3 – ozone generation equipment operating interval (duration of the relay switch). An analysis of interactions between the three variable factors was performed for each factor at ten levels. According to the assessment of the experiment design the method, which was developed by Latvian scientist V. Eglājs, Latin hypercube, which refers to the space-filling experiments, was chosen.

## 2.2. Experimental Equipment

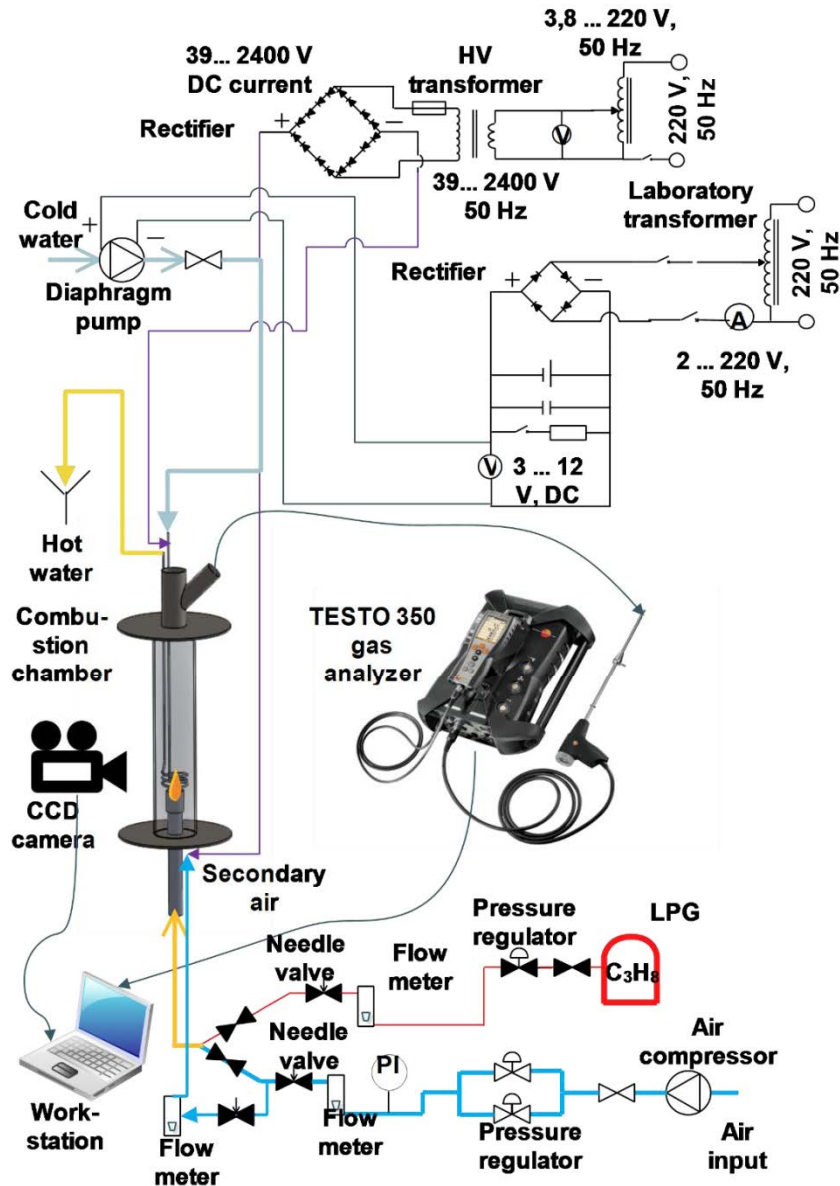

Fig. 2.2. Scheme of experimental equipment for the first stage of the research.

The experimental equipment used for the research consists of a number of individual components whose operation is synchronised in a single process and allows the analysis of the measured data for a single mode. The experimental equipment has the following components: a monochrome CCD camera and high-speed camera for flame shape visual analysis, an industrial flue gas analyser (TESTO 350), a flame-sound recording device with a sound amplifier, a voltage regulation unit, a voltage multiplication and a current rectification unit, a high-voltage ignition unit, an air supply compressor, an air flow regulation and adjustment unit, an accounting unit, fuel gas supply unit, gas flow regulation and adjustment unit, flow mixing unit, a combustion chamber with two-stage air flow decomposition, and a workstation for data processing. In addition to these components, a specially designed ozone gas generation device



(including the Generation Time Control Module) was used during the third stage of the study. For the third stage of the research a specially designed high-speed switching unit (with a high-voltage MOSFET type transistor), and an electronic four-channel oscilloscope was used.

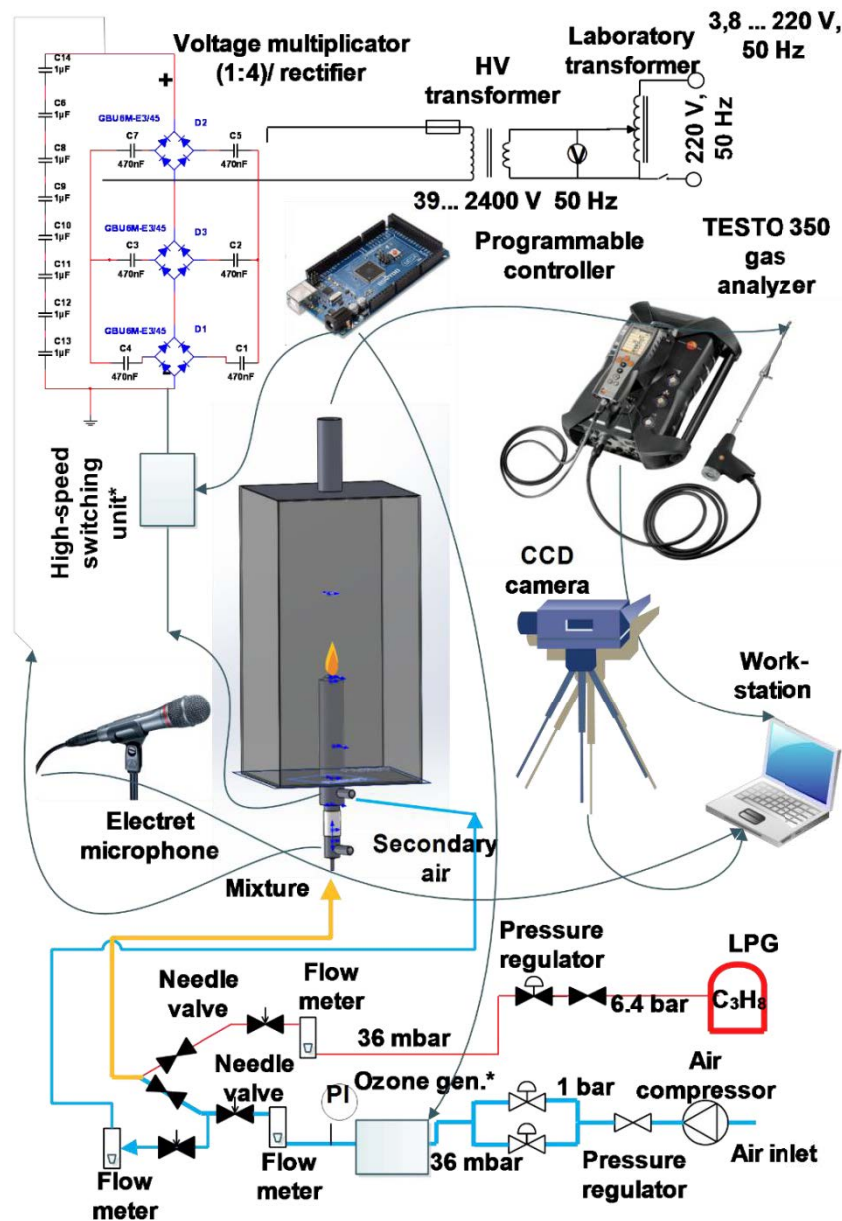

Fig. 2.3. Scheme of experimental equipment for the second and third stage of the research.

In the first stage of the research, the combustion chamber consisted of a cylindrical quartz glass flask with a height of 350 mm, an external diameter of 100 mm and a glass wall thickness of 5 mm. The representation of the experimental scheme is shown in Fig. 2.2. A hermetically closed burner was installed inside the combustion chamber. The upper part of the combustion chamber consists of a metal sheet of a diameter of 150 mm, to which a flue gas discharge pipe with a height of 500 mm was attached. In order to connect the flue gas analyser, a short pipe was connected in the top of the combustion chamber at an angle of  $45^\circ$  relative to the flue gas flow at a distance of 50 mm from the top of the glass flask. A copper tube, 4 mm in diameter,

consisting of three rings (hereinafter – coil) around the flame, was used to generate the electric field. A water diaphragm type direct current pump was used for cooling the copper coil the capacity of which was regulated by DC voltage using an additional autotransformer and rectifier. The position of the copper coil relative to the burner was changed in a vertical direction.

To conduct the second and third stage of the research, a different construction combustion chamber and a two-stage gas burner was designed. The new burner was equipped with a built-in insulated electrode to study the effects of an electric field on the burning process. The combustion chamber was constructed of carbon steel with a sheet thickness of 2 mm. For visual analysis and registration of the combustion process, one vertical wall of the combustion chamber was made of refractory 5 mm glass. The combustion chamber was densely insulated for the exclusion of air suction during the experiment. A specially designed burner was inserted at the bottom of the combustion chamber. At the top of the combustion chamber (perpendicular to the flue gas flow), a flue-gas sampling short pipe was installed in order to connect the flue gas analyser. The principled representation of the experimental scheme is shown in Fig. 2.3 (for the unification of the representation of the principled scheme, the additional components used in the third stage of the research are marked with an asterisk).

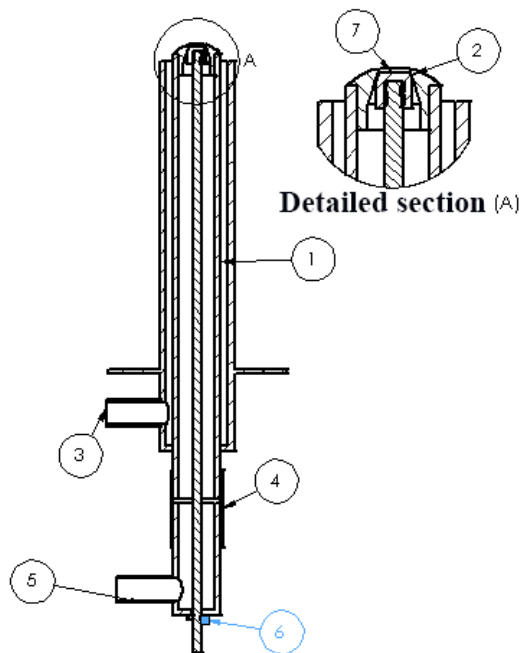

Fig. 2.4. Components of a hybrid burner of experimental equipment: 1 – air/gas supply channel; 2 – flow control unit / electric field electrode; 3 – secondary air supply channel; 4 – dielectric PVC sleeve; 5 – air/gas supply short tube; 6 – flow adjustment rod (burner-centering rod) with centering textolite rings (rings not indicated); and 7 – profiled cap of the burners.

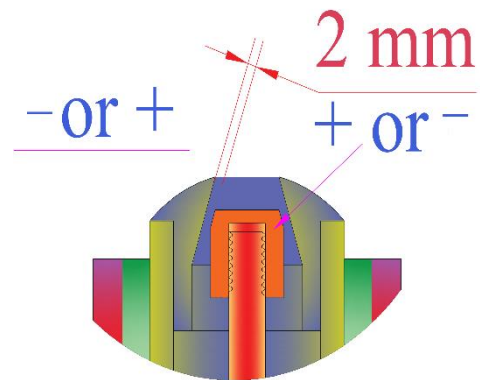

Fig. 2.5. Cross-section of the burner of an experimental unit, taking into account the 2 mm distance between the electrical conductive parts, the effective intensity of the electrostatic field according to formula,  $E = U/D$  was 0–1140 kV/m.

A special design burner (hereinafter – hybrid burner) (Figs. 2.4 and 2.5) was designed and developed for the research stage according to the scheme in Fig. 2.3. It was made of stainless steel and used to generate an electric field by connecting a high-voltage source to it. For electric field generation, the burner construction included a number of dielectric elements to ensure the separation of the outer casing of the burner from the burner core, which in turn played the role of both the air/combustible gas mixture supply control and the flame shape adjustment function. The bottom and core of the burner were insulated from the upper burner shell with a PVC insert and dielectric (textolite) centering rings. The outer diameter of the centering rings is equal to the inner diameter of the burner's primary flow channel, while for the provision of flow in it, 8 holes with a diameter of 3 mm were made. The geometry of the upper part of the core (cap) should be closely adapted to the geometry of the upper part of the outer shell of the burner, thereby ensuring the radial discharge of the mixture into the combustion zone. The design of the burner was developed to supply secondary air to the combustion zone (inside the combustion chamber) through a separate channel around the primary mixture channel. Such equipment layout and air supply method allow to analyse the premixed flame combustion, which is constructively equivalent to the full-scale industrial burners' performance indicators.

The hybrid burner design developed during research (Fig. 2.4 and 2.5) provides an effective intensity of the electrostatic field of 1140 kV/m, which several times exceeds the parameters of the equipment achieved in the studies of other scientists.

### 2.3. Analytical Assessment of the Combustion Process

For full evaluation of the combustion processes in the framework of the second and third research stages operation mode analysis of the combustion chamber and the hybrid burner was initiated, which was based on the assessment of flame and combustion parameters of premixed flame and could be integrated into combustion analysis under electrostatic field conditions. Analytical treatment based on interrelated parameters, such as fuel reduced mass fraction  $Y$  and reduced temperature  $\Theta$ , can be expressed by the following formulas:

$$Y = \frac{Y_F}{Y_F^1}, \quad (2.1)$$

$$\Theta = \frac{c_p(T-T_1)}{Q \cdot Y_F^1} = \frac{T-T_1}{T_2-T_1}. \quad (2.2)$$

In order to perform analytical assessment of the flame speed, it is possible to use Zeldovich, Frank Kamenetski and von Karman's (2.3) or Williams' (2.4) suggested analytical formulas, where heat diffusion in fresh gas is  $D_{th}^1 = \lambda/\rho_1 \cdot c_p$ :

$$s_L = \frac{1}{\beta} e^{-\frac{\beta}{2\theta_a}} (2 \cdot |B_1| \cdot T_1^{\beta_1} \cdot D_{th}^1)^{\frac{1}{2}}; \quad (2.3)$$

$$s_L = \frac{1}{\beta} \cdot \exp\left(-\frac{\beta}{2\theta_a}\right) \left(2 \cdot |B_1| \cdot T_1^{\beta_1} \cdot D_{th}^1\right)^{\frac{1}{2}} \left(1 + \frac{1.344-3\theta_a}{\beta}\right). \quad (2.4)$$

The described analytical assessment of the combustion process is used to evaluate the combustion of fuel and to determine the flame speed. This analytical evaluation was combined with a numerical analysis of the combustion process, using for this task the evaluation of

combustion kinetics in such computer programs as CHEMKIN and ANSYS Fluent simulation. For the parametric and model analysis in CHEMKIN environment, input data, which was obtained from the readings of the measuring instruments, was used after additional mathematical processing. A chemical-kinetic San Diego mechanism of University of California (includes propane oxidation reactions) was used to evaluate propane combustion, while a standard Grimech 3.0 mechanism (includes methane oxidation reactions) was used to analyse methane combustion.

## 2.4. Thermo-Acoustic Signal Assessment

For in-depth analysis of the studied process, evaluation of the flame thermo-acoustic signal under the influence of an intense electrostatic field was carried out. The processing of the flame's thermo-acoustic signal is based on the digitization of the signal and the discrete Fourier transformation (hereinafter – DFT). Discrete DFT is based on Formula 2.5:

$$X_m = \sum_{n=0}^{N-1} x_n W_N^{mn}, m = 0, 1, 2, \dots, N - 1. \quad (2.5)$$

Based on the discrete DFT signal processing algorithm, the measured acoustic signal was divided into relevant discrete parts, the digital acoustic signal analysis was performed with a subsequent transformation of DFT with a goal to determine the fundamental harmonic of the flame and its strength, depending on the intensity of the applied external electrostatic field.

### 3. RESULTS OF A GASEOUS FUEL COMBUSTION RESEARCH UNDER ELECTROSTATIC FIELD CONDITIONS

#### 3.1. First Stage of the Research

The first stage of the research is based on an electrostatic field impact analysis on the combustion of liquefied propane gas using a DC and AC source, one of the potentials was connected to the external electrode, while the other potential – to the burner shell. In addition, a vertical change in the position of the external electrode was provided with the aim of identifying the best electrode deployment variant, which gives greater impact on volatiles concentration in the flue gas.

A copper tube (coil) was used to generate an external electrostatic field, which was placed around the flame. The coil consisted of three windings and a diaphragm-type water pump with a constant water intake temperature to cool it. Changes in the concentration of harmful emissions under the influence of electrostatic field were analysed in two phases. In the first phase, a full range of DC and AC voltage was analysed, ranging from 30 V to 1800 V. In the second phase a low-voltage range (30–280 V) with a lower voltage setting step was analysed.

Graphic-analytical results of the study demonstrate a decrease in oxygen content in the flue gas. The initial position corresponds to 100 % and according to Fig. 3.1, the oxygen content in the flue gas decreased by 23 % compared to the initial combustion mode without an electrostatic field. The largest oxygen reduction in the flue gases was achieved at AC with a grid frequency of 50 Hz.

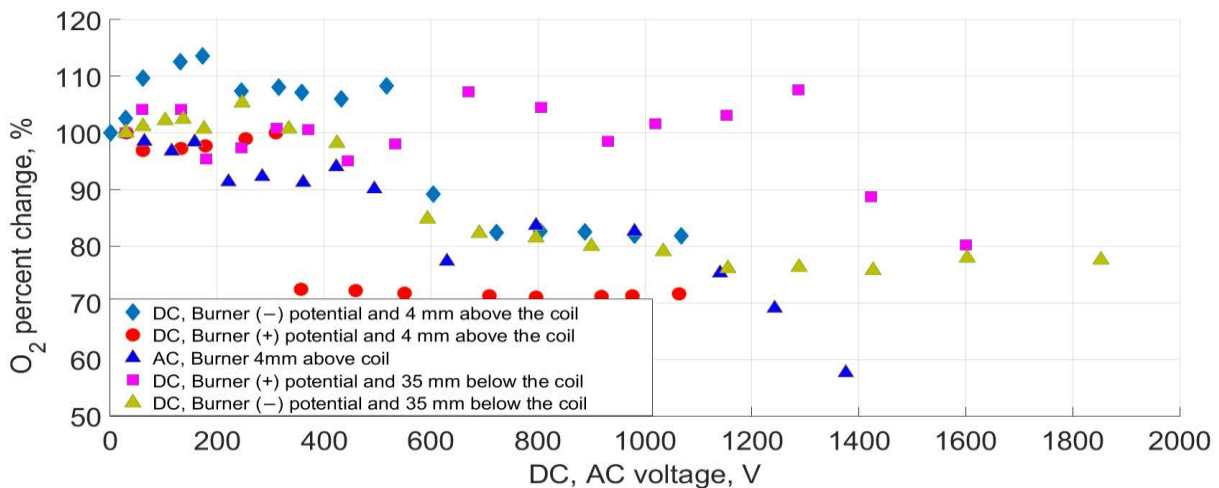

Fig. 3.1. Electrostatic field impact (0–1800 V) on oxygen (O<sub>2</sub>) content in flue gases.

Comparing the influence of AC and DC electrostatic fields on the oxygen content in flue gases, it was concluded that under the influence of AC electric field, the reduction of oxygen is more stable.

The results of the study show that the use of an electrostatic field with an external electrode whose temperature was constant and minimized any possibility for electrode's resistance rise, depending on the type of electrostatic field (AC or DC), contributes to a reduction in the oxygen

molar fraction – this indicates the combustion process efficiency improvement. However, contrary to the average reduction of the oxygen molar fraction, an increase in NO<sub>x</sub> emissions was recorded, representing in some cases 5 % compared to the baseline (Fig. 3.2). Such increases in NO<sub>x</sub> emissions could be linked to the local increase in flame front temperature, which increases the formation of thermal NO<sub>x</sub> emissions according to Zeldovich mechanism. Only within the range of a significant decrease in oxygen volume in the flue gas, the NO<sub>x</sub> concentration has decreased by 3 %.

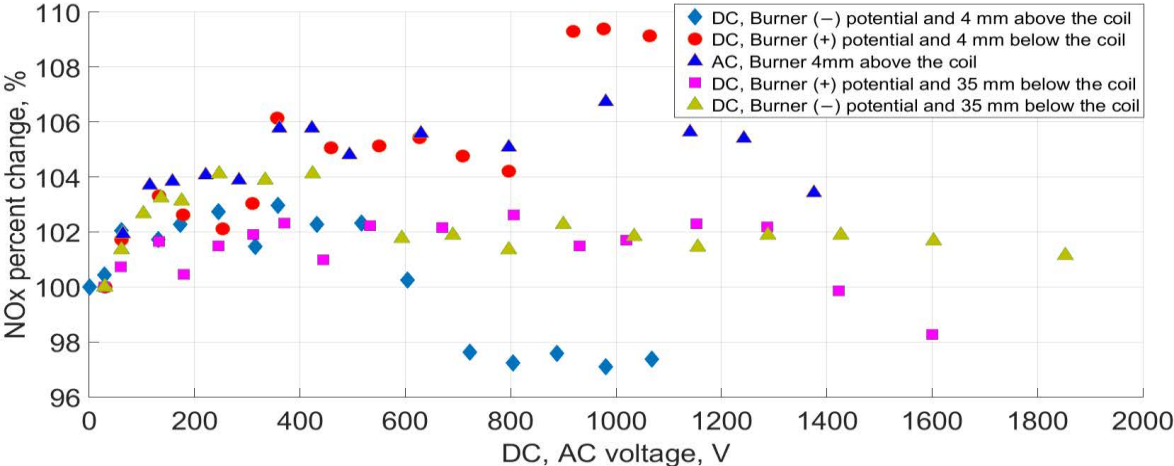

Fig. 3.2. Electrostatic field impact (0–1800 V) on nitrogen oxides (NO<sub>x</sub>) concentration in flue gases.

In the voltage range from 400 V to 1800 V, a sharp increase in CO emissions was noted, which is associated with a decrease in free oxygen in flue gases.

In the second phase of the study, at a voltage range of 30–400 V, the molar fraction of carbon monoxide decreases and reaches its minimum at a voltage of 150 V when the negative potential is connected to the burner shell (Fig. 3.3).

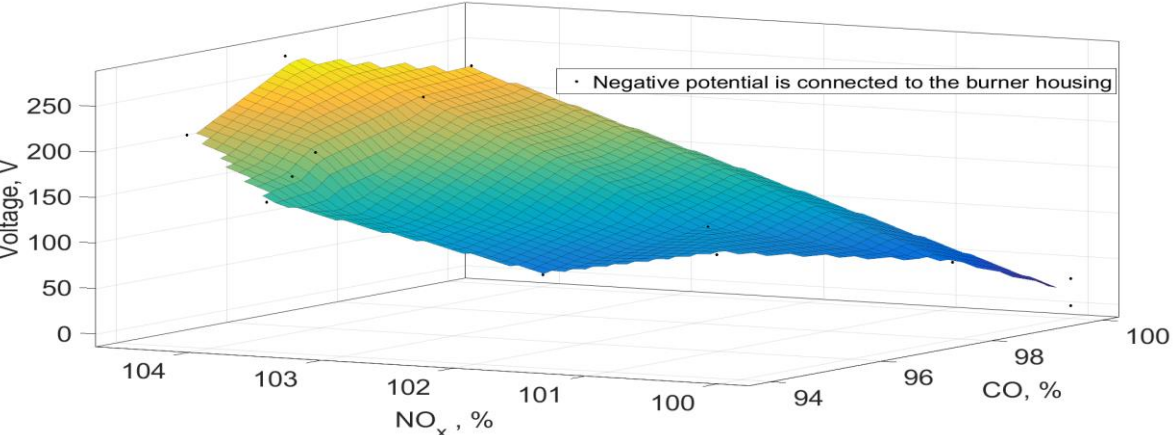

Fig. 3.3. Electrostatic field impact on CO and NO<sub>x</sub> concentration in flue with negative connected potential to the burner (0–280 V).

The largest recorded reduction in CO is 6 % compared to the baseline, while NO<sub>x</sub> concentrations increased by 3.5 % at the same voltage. Specific reduction of CO is greater than

the change in  $\text{NO}_x$  concentration, thus it can be concluded that the low-voltage (30–280 V) DC electrostatic field with external electrode has a positive impact on emissions.

### 3.2. Second Stage of the Research

The second stage of the research is based on an analysis of the impact of intensive electrostatic field on the combustion of liquefied propane gas, including visual recording of the flame front, an analysis of changes in flue gas composition, as well as the treatment of the thermo-acoustic signal using DFT method.

In the second and third stages of the research, a combustion chamber of the same design was used, whereby, in addition to direct measurements, a numerical analysis of the combustion process was carried out using a simulation method based on realistic chemical-kinetic mechanisms. For this numerical analysis, actual recorded air and gas flows were used.

A full analysis of the combustion process and the preparation before an experiment requires both a numerical-analytical analysis of the process and the processing of empirical data from the physical experiment. The combination of these two steps simplifies the realization of the laboratory experiment, increases the accuracy of measured data and improves the quality of physical justification of the observed process. In the process analysis, a model identical to the experiment was used without accepted simplifications for the purpose of using numerically calculated data as a complement to empirical data.

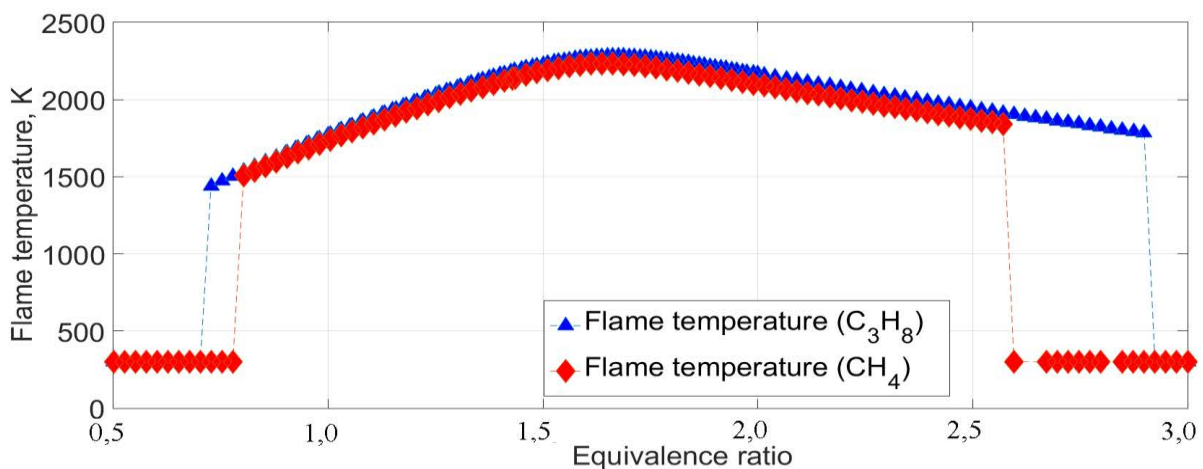

Fig. 3.4. The maximum flame temperature in the combustion zone, depending on the stoichiometric ratio of the fuel/air mixture.

To improve the accuracy of the computer simulation numerical analysis, *Ansys Fluent* standard combustion process reactions were replaced by 270 chemical reactions from the *Ansys CHEMKIN-PRO San Diego* computer program. In addition, thermodynamic properties of chemicals were determined by CHEMKIN's thermodynamic database. In the framework of the current analysis, the aforementioned computer simulation tools were used for deep investigation of the combustion process ignoring the impact of an electric field, identifying the main combustion process parameters that could not be physically measured under the specific



conditions. The combination of a numerical method with empirical data provides an opportunity to obtain a broad profile of the subject.

The results of the numerical analysis of the combustion process show that the burner constructed within this research is capable to secure propane burning within a wide range of equivalence factors from  $\phi = 0.73$  to  $\phi = 2.90$  (determined by the proportion of fuel/air in the reactor zone), which is equivalent to the propane molar fraction range  $W_{C_3H_8} = 0.029 \dots 0.108$ . The dependency of the equivalence factor on the maximum flame temperature in the combustion zone as parametric variation function is shown in Fig. 3.4.

In addition to the above mentioned temperature distribution, it is concluded, according to the results of the *CHEMKIN* simulation, that the effects of the electrostatic field on the combustion process were carried out at  $\phi = 1.28$  ( $O_2$  content in the flue-gases  $\sim 3.4\%$ ), which corresponds to the oxygen molar concentration in flue-gases according to recorded data with the TESTO 350 flue-gas analyser.

Based on the results of *Ansys CHEMKIN-PRO*, an additional analysis of the flame-combustion parameters was performed in the *Ansys Fluent Flow* simulation computer program. This software provides wider description of the flame burning properties for the current given experimental unit. According to the results of the computer simulation of *Ansys Fluent Flow*, it can be concluded that the flame speed at the root of the flame is equal to  $s_L = 0,492453$  m/s, while the flame speed in the upper part of the flame decreases to  $s_L = 0,37665$  m/s.

Depending on the DC connection layout, two sets of flame visual data were processed, with a positive and negative connected potential to the burner-centering rod. Under these conditions, the voltage range was increased while keeping all other parameters unchanged. At this stage of the study, the fuel input capacity was  $0.17$  kW<sub>th</sub>. As reference point for flame-shape comparison, flame visual information was used, which was taken in electrostatic free conditions. To determine the deviations of flame shape, the pictures were supplemented with the coordinates of pixels.

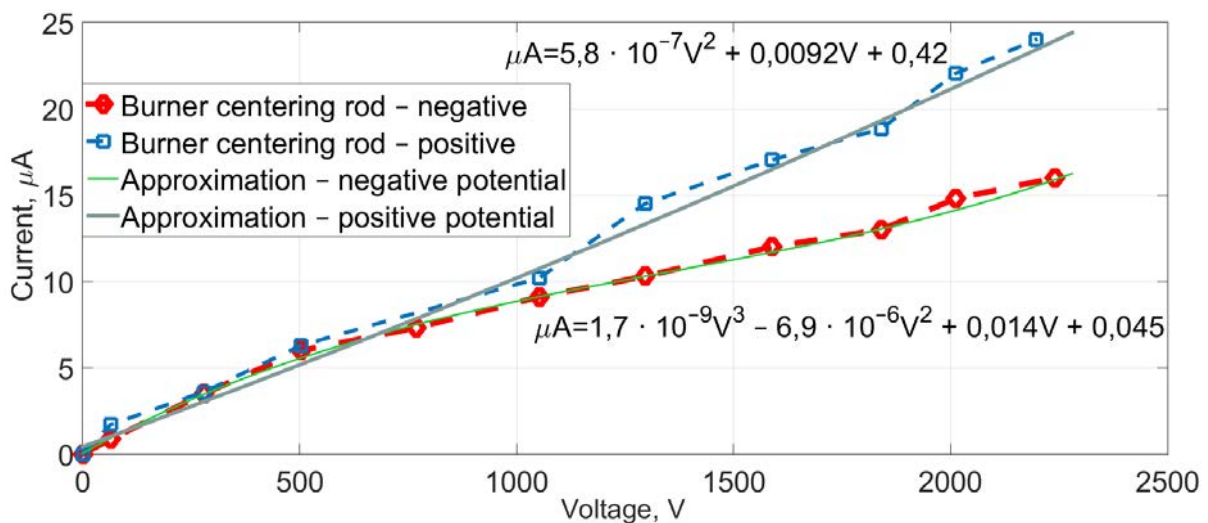

Fig. 3.5. Voltage-current characteristics.



In the framework of the study, the maximum flame-consumed current was  $24 \mu\text{A}$ , when a positive potential was connected to the burner-centering rod. According to the voltage-current characteristics (Fig. 3.5), it is concluded that the consumed current significantly increases starting from 1300 V, when the effect of ionic wind appears. These results have a good correlation with the picture of flame-shape changes (Fig. 3.6).

According to the flame shape and length change analysis it can be concluded that the electrostatic field impact on the flame shape with the negative connected potential to the burner-centering rod is minimal. This is due to the relatively small surface area ( $12 \text{ mm}^2$ ) of the centering rod, which performed the function of the electrode. Taking into account that the electrode of the burner-centering rod was located below the root of the flame, the drift of the positive ions from the flame front to the negative electrode is practically unattainable. These results show that such arrangement of the electrode and the connection of a DC source contribute to a minimal change in flame shape compared to the combustion mode without the use of an electrostatic field.

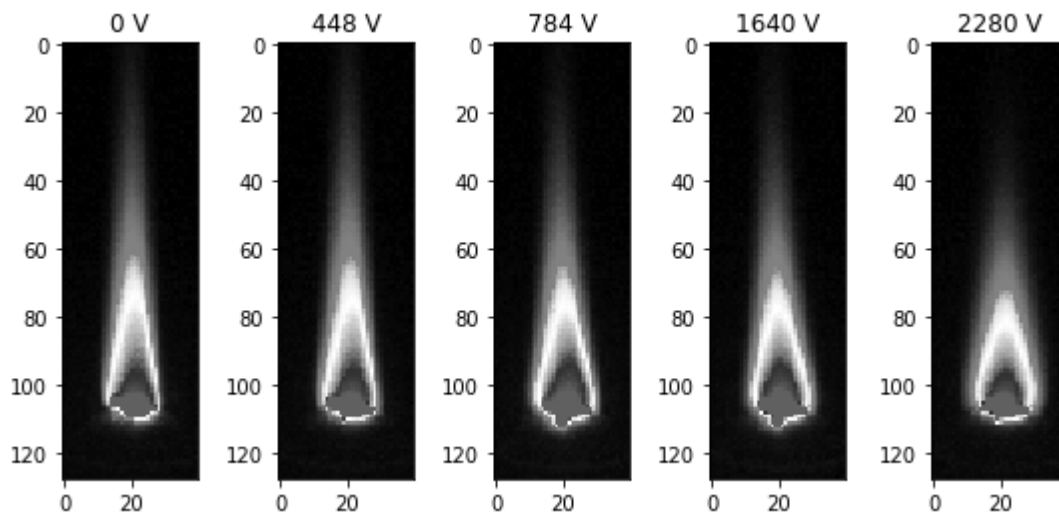

Fig. 3.6. Graphical comparison of the flame shape in the voltage range 0–2280 V with a positive connected potential to the burner-centering rod and a negative connected potential to the burner shell.

According to the graphical results with the positive connected potential to the burner-centering electrode, it is apparent that starting from 400 V the length of the flame kernel is decreasing, while starting from 700 V there is an extension of the root of the flame. This could be explained by a positive ion drift to the burner shell to which the negative potential was attached. The impact of the electrostatic field (Fig. 3.6) on the change in flame length is significant and its contraction is 24 % compared to the burning mode without using an electrostatic field. The flame root extension, however, is 27 %. These results show that an electrode with a diameter that is 2.5 times larger than the flame diameter constitutes a proportional reduction in the length of the flame kernel and an extension of the root of the flame. Such a change in the flame shape, while remaining unchanged for the remaining parameters, improves the combustion process while reducing CO emissions into the atmosphere and increasing the local flame temperature.

In the framework of the research, an analysis of the flue gas composition was performed using a specially designed inspection point in the combustion chamber. The sampling point was created at the top of the vertical wall of the combustion chamber, which ensured the placement of the flue gas analyser TESTO 350 measuring probe perpendicular to the flue gas flow.

In the framework of the flue gas analysis, the following parameters were measured: percentage of oxygen in the flue-gases  $O_2$ , concentration of carbon monoxide in the flue-gases CO, carbon dioxide in the flue-gases  $CO_2$ , concentration of nitrogen oxide in the flue gases NO, concentration of nitrogen dioxide in the flue-gases  $NO_2$ , concentration of nitrogen oxides in the flue-gases  $NO_x$ , and flue gas temperature.

In the experiment, when the burner shell was used as an anode, an increase in oxygen content in the flue gases was observed, ranging from 4.14 % to 4.35 %. Whereas in the second experiment, when the burner shell was used as a cathode, the oxygen content in the voltage range 0–1300 V was reduced parabolically from 3.72 % to 3.6 %. From 1300 V oxygen content increases to its original state (Fig. 3.7).

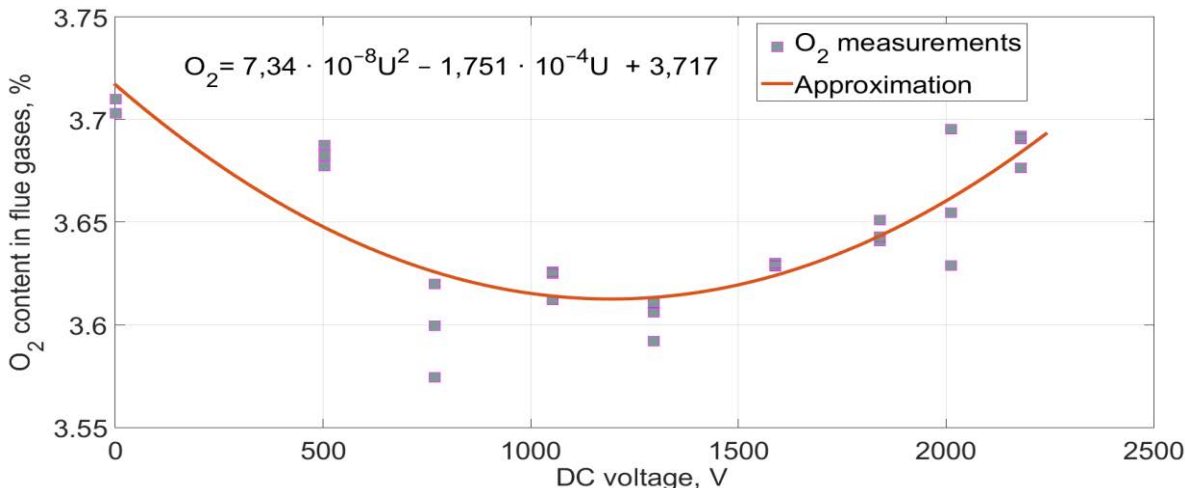

Fig. 3.7. Oxygen content in flue gases under the influence of an electrostatic field with a positive connected potential to the burner-centering rod.

Temperature of flue gas is directly proportional to the flame combustion temperature up to which determination of the flame temperature changes was carried out based on flue gas temperature registration via a flue gas analyser probe with an integrated thermocouple. According to the measurement results of the first experiment (the burner shell was used as the anode) temperature of flue gas evenly descends, which correlates with the oxygen content change in the flue gas. At the maximum electrostatic field intensity, a decrease in the flue gas temperature of 7.5 °C was noted, which is 3.5 % compared to the combustion mode without the use of an electrostatic field. In the second experiment with a positive-connected potential to the burner-centering rod (the burner shell was used as a cathode) it was found that starting from 1300 V, the temperature of the flue gases begins to increase parabolically, reaching its peak (199 °C) at a maximum electrostatic field strength of 1140 kV/m (Fig. 3.8).

According to the results of the study, the maximum specific increase in nitrogen oxides ( $\text{NO}_x$ ) concentration was 10 % at 525 kV/m electrostatic field intensity when the burner shell was used as an anode. In these conditions, the maximum reduction in the concentration of carbon monoxide (CO) was  $35 \text{ mg/m}^3$ , which is equivalent to a specific reduction of 5.2 %. However, when the burner shell was used as a cathode and the burner-centering rod as an anode, the maximum increase in  $\text{NO}_x$  emissions was 5.3 %, while the reduction in CO emissions reached 7.1 % compared to baseline. An improvement in the combustion process was found in an experiment with a positive connected potential to a burner-centering rod and simultaneous electrostatic field intensity of 525 kV/m, carbon dioxide ( $\text{CO}_2$ ) in the flue gases increased by 0.07 %, which is equivalent to a specific increase of 0.6 %.

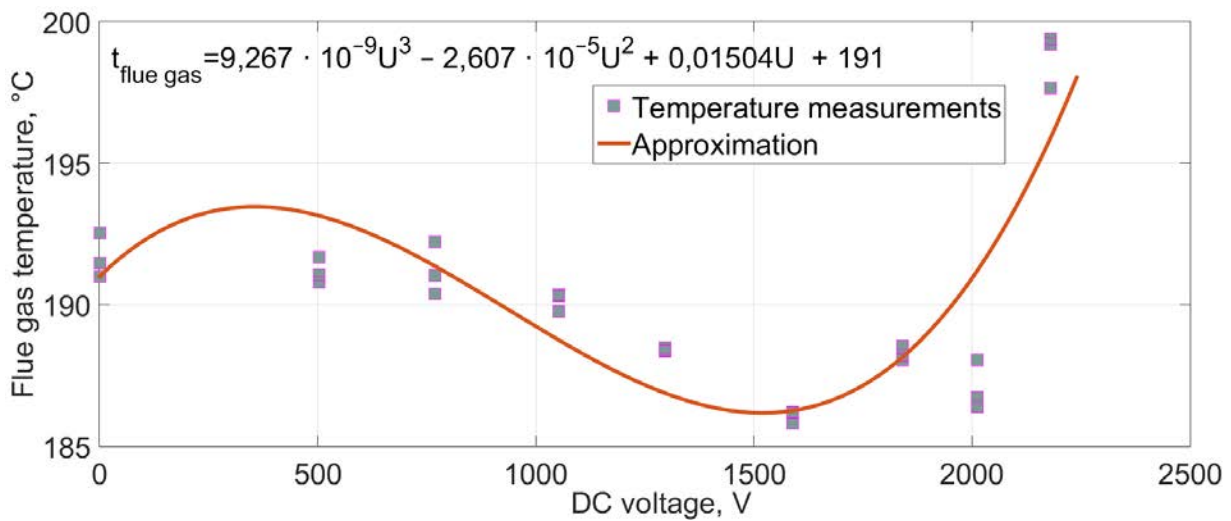

Fig. 3.8. Flue gas temperature under the influence of an electrostatic field with a positive connected potential to the burner-centering rod.

The flame thermo-acoustic signal under the influence of electrostatic field was analysed using an electret microphone for the sound range 0.02–16 kHz, which was placed on the same level as the average flame plane. In the study an evaluation of the signal spectrogram was performed in the time and frequency domain, whereas for the specific signal measurement deviations an DFT method was used.

Based on the processed acoustic signal results in the full frequency range 0.02–25 kHz, it can be concluded that no change in the amplitude of the acoustic flame signal is observed starting from 2 kHz. The fundamental recorded harmonic according to the DFT analysis of the acoustic signal is 150 Hz. It should be noted that the same fundamental harmonic was recorded at both variations of the DC polarity connection.

The DFT analysis shows that the connection of DC's positive potential to the burner-centering rod and the simultaneous connection of negative potential to the burner shell has a significant impact on the flame acoustic signal (noise) enhancement. According to the comparison of signal amplification at peak voltage (2280 V), the signal amplitude is 115 times higher compared to the baseline.

From the above results, it is concluded that the electrostatic field, in addition to the impact on the flame frontal shape changes and harmful emissions formation, also influences the acoustic effect of the flame, which is to be expressed as an increase in the acoustic signal of the flame, depending on the intensity of the electrostatic field. Moreover, the intensive electrostatic field does not have an additional effect on the sound frequency range and the number of signal harmonics.

### 3.3. Third Stage of the Research

The goal of the third stage of the research is to determine the effects of multivariate interaction on the composition of flame combustion products. The multivariate impact analysis is based on an analysis of the variation in the composition of flue gases, depending on three factors: pulsating current voltage; pulsating current frequencies; and switching intervals for the ozone generating device.

The maximum pulsating current voltage was limited to 900 V, a pulsating current frequency of 10 000 Hz and an operating interval of the ozone generating device of 2000 ms. Taking into account the assessment of the safety and ozone leakage aspects, the ozone generating device was integrated into the air flow channel before mixing with the combustion gas.

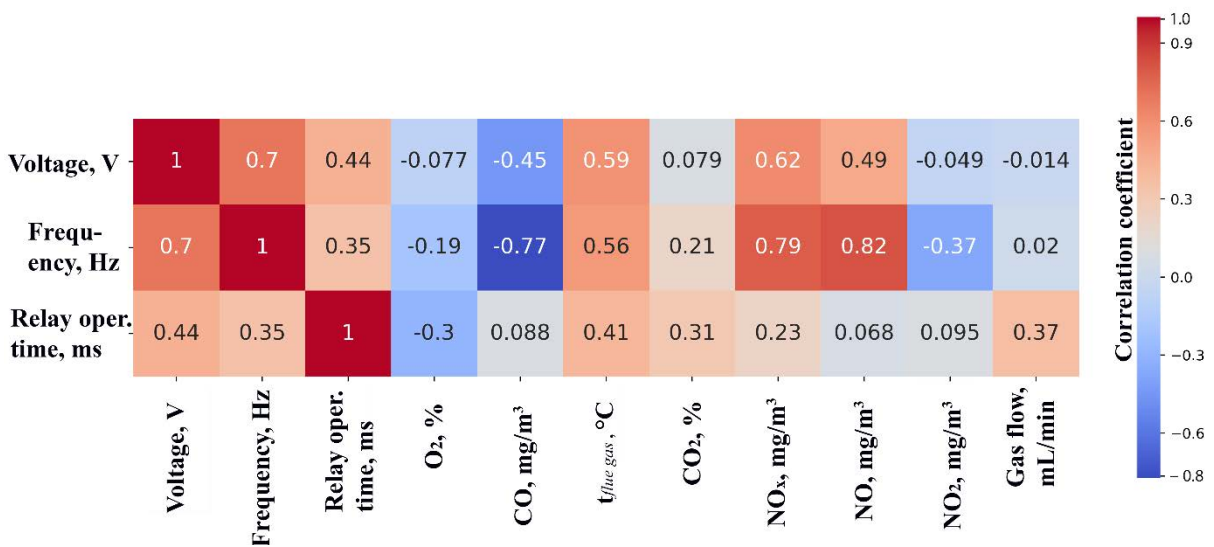

Fig. 3.9. Multivariate correlation heat map for experiment with negative pulsating current potential connected to the burner-centering rod.

For a three-factor cross-impact analysis on a number of registered responses, a cross-correlation factor was established for each variable and each response. The calculated linear correlation factors for each factor and response were compiled in a graphic form using the heat map method. The results of this interaction analysis are presented in Figs. 3.9 and 3.10.

According to the results presented in Fig. 3.9, it can be concluded that none of the factors justified a linear correlation with the oxygen content in the flue gases. However, a significant impact of the pulsating current frequency on the change in carbon monoxide (CO) concentration was detected. These results show that a sequential substitution of oxygen by ozone gas using a negative-connected pulsating potential to the burner-centering rod does not have an impact on

measurements. It should be noted that this multivariate experiment showed the impact of the set frequency of a pulsating current on NO<sub>x</sub> and NO emissions.

In an experiment with a positive pulsating current potential, which was connected to the burner-centering rod (Fig. 3.10), a good correlation was found between all three influence factors on the flue gas temperature and a change in NO<sub>x</sub> concentration. The obtained results refer to the voltage range up to 900 V. The heat map of correlation factors shows the existing relationship between the voltage and the concentration of NO<sub>2</sub> in the flue gases, as well as between the frequency of the pulsating current and the concentration of NO<sub>2</sub> in the flue-gases. In addition, the change in CO concentration in the flue gases is most dependent in conditions with increased voltage.

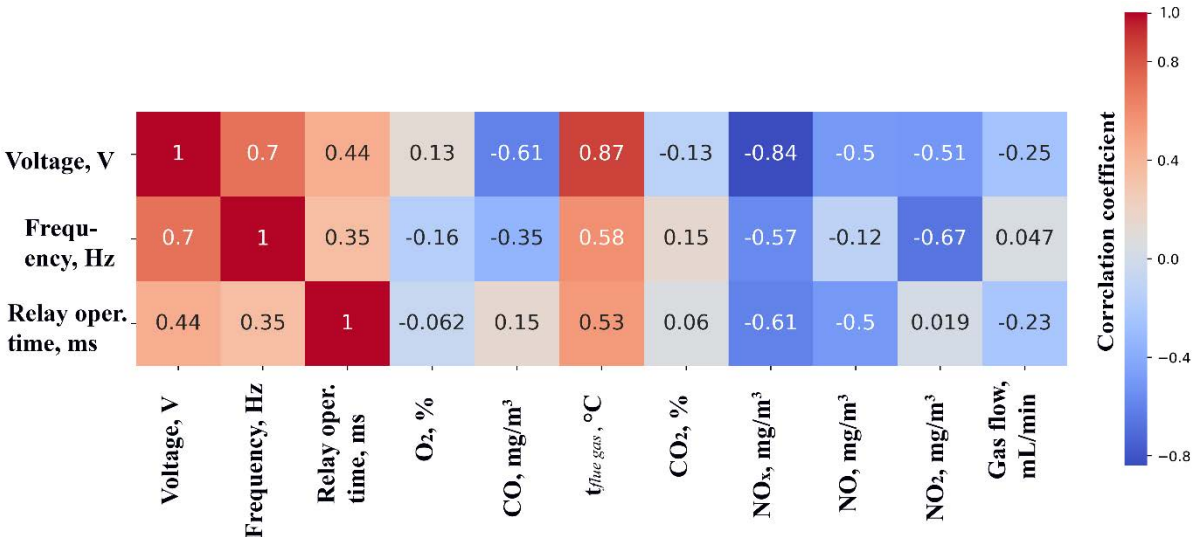

Fig. 3.10. Multivariate correlation heat map for experiment with positive pulsating current potential connected to the burner-centering rod.

The assessment of the temperature change in the flue gases, depending on three factors, proves the high potential of the pulsating current and partial ozone gas application. Each step-up level of each factor increases the temperature of the flue gases. In addition, the results of the CO emissions measurements testify a more complete combustion and better heat release from the flame.

On the basis of these results, it is concluded that the intensive electrostatic field of the pulsating current source, its pulse frequency, and the partial substitution of the oxidizer with a more active oxidising agent (ozone) improve the propane flame combustion and the heat release from the flame, which can be demonstrated by an increase in the temperature of the flue gases. In the framework of the experiment, it was found that pulsating current voltage, pulsating frequency and ozone as oxidizer have a direct effect on the rapid NO<sub>x</sub> formation process rather than on thermal NO<sub>x</sub>.

#### **4. TECHNO-ECONOMIC ASSESSMENT OF THE USE OF AN INTENSIVE ELECTROSTATIC FIELD**

On the basis of the results of this study, it is concluded that an intensive electrostatic field has a positive effect on the combustion process of gas, which is to be expressed by a more efficient burning of the gas/air mixture and an increase in the temperature of the flue gases, which generally improves the efficiency of the combustion system and ensures savings of primary energy resources. It is concluded that in application of intensive electrostatic field the changes in concentrations of flue gas components and flame shape parameters achieved in this research, can be attributed to larger scale appliances where gaseous fuel is a primary fuel.

Taking into account that the heat capacity of large-scale heat only boiler plants installed in Latvia exceeds 1200 MW<sub>th</sub>, it is important that the maintenance costs of these plants are as low as possible. These costs include the replacement of heating surfaces according to the condition of the equipment. However, the developed method and obtained research results in the context of the Doctoral Thesis have shown that the use of an intensive electrostatic field may reduce the length of the flame, which allows to restrain high local temperatures in the furnace and the negative effects on furnace tubes. The cost of this technology integration for one boiler with a capacity of around 100 MW<sub>th</sub> could reach EUR 50 000. On the other hand, the expected economy amounts up to EUR 100 000, which applies for 15 years. Taking into account the total number of installed high-capacity boilers (116 MW<sub>th</sub>) in Riga, the potential reduction in maintenance costs could reach up to EUR 550 000 by using the developed method or a costs reduction attributed to the installed capacity could reach up to 30.5 EUR/MW<sub>th</sub> per year. On the other hand, this method in application to heat only boiler plants with a nominal capacity utilisation rate of 25 % and an excess air value of  $\alpha = 1,14$  could ensure a primary energy source savings of 7100 m<sup>3</sup> per year and at the same time reduce greenhouse gas (CO<sub>2</sub>) emissions into the atmosphere by 16 tons per year. In addition, it is concluded that the proposed method of control of the combustion process for large-scale plants would be able to enhance a local flue gas recirculation in the furnace, thereby allowing for further reduction of NO<sub>x</sub> emissions in the atmosphere, as well as to develop a platform for further emissions reductions for stricter emissions requirements in the future.

## CONCLUSIONS

Based on the research carried out in the framework of the Doctoral Thesis on the assessment of the effect of an intense electrostatic field on the combustion of liquefied propane gas using direct current, alternating current and pulsating current, in particular assessing the trend of flame shape deviations (length and width) and changes of volatiles (CO, CO<sub>2</sub>, NO<sub>x</sub>) substances in flue gases, the following conclusions are drawn:

- In the framework of the low-voltage electrostatic field study when an external electrode was used around the flame, in the voltage range of 30–280 V an increase of nitrogen oxides NO<sub>x</sub> emissions by 3 % and a decrease of carbon monoxide CO emissions by 6 % was detected.
- The study resulted in the development of a hybrid burner capable to ensure an intensive electrical field with significantly higher intensity than the values of equipment used in other studies – above 1000 kV/m.
- Experimentally it was proven that there are intensive DC electrostatic field impact on flame shape changes, which begins at the intensity of 200 kV/m. At an electrostatic field intensity of the 1140 kV/m, the flame length reduction is 24 % and the extension of the flame root – 27 %.
- It was found that the intensive DC electrostatic field increased NO<sub>x</sub> emissions by 5.3 % on average, while the reduction in CO emissions reached 7.1 % compared to baseline.
- Experimental-analytical results showed that an intensive DC electrostatic field has an influence on the thermo-acoustic effect of the flame significantly increasing the amplitude of the harmonics. The results suggest that the electrostatic field does not contribute to the acoustic resonant effect of the flame.
- The results of the research have demonstrated that the pulsating current electrostatic field, combined with a sequential substitution of oxidizer (free oxygen and three atomic oxygen), allows to achieve NO<sub>x</sub> emissions reduction in the flue gases by 3.6 %, while maintaining a constant concentration of CO emissions.
- It was found that the application of a pulsating current electrostatic field in gaseous fuels combustion can increase the temperature of flue gases by 8.1 %, indicating an intensification of heat exchange.
- The developed method allows to reduce the maintenance costs of the large-scale gas fuel heat only boiler plants (boilers with installed capacity from 50 MW<sub>th</sub> to 116 MW<sub>th</sub>) by 30.5 EUR/MW<sub>th</sub> per year at 25 % of the nominal capacity utilisation rate, while ensuring primary energy source savings and greenhouse emissions reductions (CO<sub>2</sub>, NO<sub>x</sub>) in the atmosphere.