



**DESIGN,  
CONSTRUCTION  
AND MANAGEMENT  
OF WOODEN  
PUBLIC BUILDINGS**

---

Handbook

# DESIGN, CONSTRUCTION AND MANAGEMENT OF WOODEN PUBLIC BUILDINGS



Handbook

RTU Press  
Riga  
2021

Laura Tupenaite, Ineta Geipele, et al. **Sustainable Public Buildings Designed and Constructed in Wood**. RTU Press, 2021. 403 p.

**Scientific Editors:**

Assoc. Prof. Dr. Laura Tupenaite, Prof. Dr. Ineta Geipele

The handbook presents significant theoretical and practical solutions in design, construction and management of sustainable wooden public buildings, based on experiences in five countries – Lithuania, Denmark, UK, Finland and Latvia, as well as in the international context. Understanding of sustainable development and the importance of wooden construction discussed, properties of wood as a construction material analysed, design solutions, including moisture, fire safety and acoustical considerations provided, wooden construction project and process management addressed, use and maintenance, including planning and inspections described, most common reasons of failures identified.

The handbook is primary intended for undergraduate students who study design and construction of sustainable buildings. The presented materials are relevant not only in the academic context, but may be significant to all stakeholders in construction and real estate markets who are committed to sustainable construction in wood.

The preparation and publication of handbook was funded by project "Sustainable Public Buildings Designed and Constructed in Wood", No: 2018-1-LT01-KA203-046963.



Literary Editor Daina Ostrovskā  
Design Baiba Puriņa  
Cover design Paula Lore

<https://doi.org/10.7250/9789934225758>  
ISBN 978-9934-22-575-8 (pdf)  
ISBN 978-9934-22-574-1 (print)

© Riga Technical University, 2021

# Authors

**Anssi Knuutila,**

Häme University  
of Applied Sciences

**Araz J. Agha,**

School of Energy,  
Construction and Environment,  
Coventry University

**Carl Mills,**

School of Energy,  
Construction and Environment,  
Coventry University

**David Trujillo,**

School of Energy,  
Construction and Environment,  
Coventry University

**Ilona Koivula Mercedes,**

Häme University of Applied Sciences

**Ineta Geipele,**

Institute of the Civil Engineering  
and Real Estate Economics,  
Riga Technical University

**Janis Zvirgzdins,**

Institute of the Civil Engineering  
and Real Estate Economics,  
Riga Technical University

**Jari Komsj,**

Häme University of Applied Sciences

**Jurga Naimaviciene,**

Department of Construction  
Management and Real Estate,  
Vilnius Gediminas Technical  
University

**Kristine Fedotova,**

Institute of the Civil Engineering  
and Real Estate Economics,  
Riga Technical University

**Laura Tupenaite,**

Department of Construction  
Management and Real Estate,  
Vilnius Gediminas Technical  
University

**Loreta Kanapeckiene,**

Department of Construction  
Management and Real Estate,  
Vilnius Gediminas Technical  
University

**Maris Kalinka,**

Institute of the Civil Engineering  
and Real Estate Economics,  
Riga Technical University

**Mindaugas Krutinis,**

Study and Consulting Center

**Ole Thorkilsen,**

VIA University College

**Per Sorensen,**

VIA University College

**Peter Ebbesen,**

VIA University College

**Petri Lento,**

Häme University of Applied Sciences

**Roger Howard Taylor,**

VIA University College

**Simona Krasauskiene,**

Study and Consulting Center

**Taneli Rasmus,**

Häme University of Applied Sciences

**Tomas Gecys,**

Department of Steel  
and Composite Structures,  
Vilnius Gediminas Technical  
University

**Zhoncheng Ma,**

Häme University of Applied Sciences



# Content

Foreword – Pub-Wood project .....	8
Introduction.....	9

## Chapter 1

---

### Sustainable Development and Wooden Construction

<b>1.1. Understanding the Concept of Sustainable Development.....</b>	<b>14</b>
<i>Loreta Kanapeckiene, Jurga Naimaviciene, Simona Krasauskiene</i>	
<b>1.2. Sustainable Construction .....</b>	<b>22</b>
<i>Laura Tupenaite, Loreta Kanapeckiene, Jurga Naimaviciene, Simona Krasauskiene</i>	
<b>1.3. Sustainable Construction in Wood.....</b>	<b>31</b>
<i>Roger Howard Taylor, Laura Tupenaite, Carl Mills, Araz J. Agha</i>	
<b>1.4. Sustainable Building Rating Systems.....</b>	<b>52</b>
<i>Carl Mills, Araz J. Agha, Laura Tupenaite, Simona Krasauskiene</i>	
<b>References .....</b>	<b>90</b>

## Chapter 2

---

### Wood as a construction material

*David Trujillo*

<b>2.1. Introduction: Timber in the Climate Emergency.....</b>	<b>96</b>
<b>2.2. Macroscopic Characteristics of Wood .....</b>	<b>98</b>
<b>2.3. Microscopic Characteristics of Wood .....</b>	<b>103</b>
<b>2.4. Physical Properties of Wood.....</b>	<b>105</b>
<b>2.5. Mechanical and Elastic Properties .....</b>	<b>109</b>
<b>2.6. Durability of timber .....</b>	<b>114</b>
<b>2.7. Variability .....</b>	<b>118</b>
<b>2.8. Behaviour in Fire.....</b>	<b>121</b>
<b>References .....</b>	<b>125</b>

## Chapter 3

---

### Design of Sustainable Public Buildings

<b>3.1. Building Design by BIM .....</b>	<b>127</b>
<i>Peter Ebbesen</i>	

<b>3.2. Load Bearing Structures</b> .....	<b>138</b>
<i>Tomas Gecys</i>	
<b>3.3. Moisture Performance</b> .....	<b>149</b>
<i>Anssi Knuutila</i>	
<b>3.4. Fire Safety</b> .....	<b>165</b>
<i>Taneli Rasmus</i>	
<b>3.5. Acoustics and noise-abatements</b> .....	<b>173</b>
<i>Carl Mills</i>	
<b>3.6. Design of Building Service System</b> .....	<b>181</b>
<i>Ole Thorkilsen</i>	
<b>References</b> .....	<b>194</b>

## Chapter 4

---

### Management and Leadership in Construction Project

*Jari Komsa*

<b>4.1. Construction Project Management</b> .....	<b>198</b>
<b>4.2. Construction Project Stages</b> .....	<b>200</b>
<b>4.3. Management and Leadership</b> .....	<b>206</b>
<b>4.4. Safety Management</b> .....	<b>209</b>
<b>4.5. Quality Management</b> .....	<b>212</b>
<b>4.6. Principles of Making Construction Schedule</b> .....	<b>214</b>
<b>References</b> .....	<b>217</b>

## Chapter 5

---

### Construction Process

<b>5.1. Typical Wooden Construction Solutions</b> .....	<b>219</b>
<i>Petri Lento</i>	
<b>5.2. Quality Assurance</b> .....	<b>221</b>
<i>Petri Lento</i>	
<b>5.3. Construction Process Management Guide</b> .....	<b>224</b>
<i>Per Sorensen</i>	
<b>5.4. Process Management in Timber Construction</b> .....	<b>241</b>
<i>Petri Lento</i>	
<b>Appendixes</b> .....	<b>250</b>
<b>References</b> .....	<b>262</b>

## Chapter 6

---

### Use and Maintenance

<b>6.1. Fundamentals of Building Use and Maintenance .....</b>	<b>264</b>
<i>Ineta Geipele, Maris Kalinka, Janis Zvirgzdins</i>	
<b>6.2. Use of Digital Technologies in Real Estate Management .....</b>	<b>278</b>
<i>Maris Kalinka, Ineta Geipele, Janis Zvirgzdins</i>	
<b>6.3. Data Base for Management Purposes .....</b>	<b>303</b>
<i>Maris Kalinka, Ineta Geipele, Janis Zvirgzdins</i>	
<b>6.4. Maintenance Management Plan .....</b>	<b>317</b>
<i>Maris Kalinka, Ineta Geipele, Janis Zvirgzdins</i>	
<b>6.5. Maintenance and Repair Works .....</b>	<b>331</b>
<i>Laura Tupenaite, Mindaugas Krutinis</i>	
<b>6.6. Failures of Wooden Buildings and Preventive Actions.....</b>	<b>343</b>
<i>Laura Tupenaite, Mindaugas Krutinis</i>	
<b>References .....</b>	<b>356</b>

## Chapter 7

---

### Examples

<b>7.1. Examples in Latvia .....</b>	<b>362</b>
<i>Kristine Fedotova, Ineta Geipele, Janis Zvirgzdins</i>	
<b>7.2. Example in Lithuania .....</b>	<b>372</b>
<i>Tomas Gecys</i>	
<b>7.3. Example in the UK .....</b>	<b>376</b>
<i>Carl Mills, David Trujillo</i>	
<b>7.4. Examples in Denmark .....</b>	<b>380</b>
<i>Roger Howard Taylor, Ole Thorkilsen, Peter Ebbesen</i>	
<b>7.5. Example in Finland .....</b>	<b>388</b>
<i>Jari Komsj, Anssi Knuutila, Koivula Ilona Mercedes</i>	
<b>7.6. International Examples .....</b>	<b>393</b>
<i>Carl Mills, David Trujillo, Tomas Gecys</i>	

# FOREWORD – PUB-WOOD PROJECT

---

Preparation and publication of handbook “Design, Construction and Management of Wooden Public Buildings” was funded by the Erasmus+ Programme of the European Union, project “Sustainable Public Buildings Designed and Constructed in Wood” (Pub-Wood), No. 2018-1-LT01-KA203-046963.

The Pub-Wood project was a two-year project aimed at developing a trans-disciplinary and transnational course / elective element in the EU HEIs on the design, construction and management of sustainable public wooden buildings in order to enhance the quality and relevance of students’ knowledge and skills for future labour market needs.

The specific objectives of the project:

- To strategically research at which level sustainable design, construction and management of wooden public buildings are to be planned and implemented in the partner countries.
- To educate all participants (students, teachers, entrepreneurs) in the field of the sustainable wooden construction.
- To develop and implement the new strategic trans-disciplinary module / elective element, which meets the needs of the HEIs and market representatives, fulfils the future challenges of sustainable public wooden buildings’ design, construction and management.
- To improve competencies of students and teachers in problem solving and team work, innovative thinking, motivation, awareness of cross-professional project input and project management by using real problem-based and blended learning approaches.
- To ensure open awareness of the project results to local, national, EU level and international target groups.

The project was implemented by five higher education institutions: Vilnius Gediminas Technical University (Lithuania), VIA University College (Denmark), Coventry University (United Kingdom), Häme University of Applied Sciences (Finland) and Riga Technical University (Latvia), as well as by Lithuanian State Enterprise Centre of Registers and Study and Consulting Center.

More information about the project can be found in the project’s website: <http://www.pubwood.eu/>

# INTRODUCTION

---

Nowadays advanced companies in the construction sector are keen to use construction materials that have a lower environmental impact, and in this context, stakeholders increasingly see wood as natural and sustainable option for large public buildings. If public institutions and business enterprises express their ecological concerns by using wood constructions for public buildings, it is a clear indicator of a mature society which focuses on sustainable development.

Education in wooden design and construction is still very limited across Europe. Most of HEIs that award technical degrees in design, construction and materials for complex buildings have curricula that include the studies of concrete and steel, being prefabricated or manufactured on site. Normally education in construction from wood focuses on one to two storey buildings. Therefore, there is an urgent need to educate students with innovative applied skills needed in the construction of massive wooden structures and large public buildings at the undergraduate degree level. For this purpose, handbook “Design, Construction and Management of Wooden Public Buildings” was published.

The handbook deals with significant theoretical and practical issues in design, construction and management of wooden public buildings, based on experiences in five countries – Lithuania, Denmark, UK, Finland and Latvia, as well as in the international context. The handbook is interdisciplinary in nature; contributions of the authors can be linked to structural engineering, construction, economics and management fields.

The handbook is primary intended for undergraduate students who study design and construction of sustainable wooden buildings. Indeed, the presented materials are relevant not only in the academic context, but may be significant to all stakeholders in construction and real estate markets who are committed to sustainable construction in wood.

Handbook “Design, Construction and Management of Wooden Public Buildings” contains seven consecutive chapters.

Chapter 1 introduces the concept of sustainable development and the importance of wooden construction in achieving the goals of sustainable



development goals. History of the sustainable development and its evolution to nowadays is discussed, key pillars of sustainable development (economic, social, and environmental) are described in detail.

As in many countries construction has been identified as the first sector to require specific attention in meeting the sustainable development goals, special attention is paid to the definitions of sustainable construction. In the context of construction, selection of wood as building material is an option to achieve sustainable construction from the environmental, economic and social perspectives. Therefore, sustainability benefits of wooden construction are analysed.

Finally, the most popular sustainable building rating systems – Building Research Establishment’s Environmental Assessment (BREEAM) and Leadership in Energy and Environmental Design (LEED®) are presented, also Passive House (Passivhaus) standard is discussed. Certification of public wooden buildings according to these systems is illustrated by different case studies from the UK, Italy, USA and Canada.

Chapter 2 is dedicated to analysis of wood as a construction material. It covers macroscopic characteristics of wood: physical properties (moisture content, brittleness and ductility), durability of timber, variability, behaviour in fire. The chapter is based on Eurocodes and illustrated by findings of the experimental tests.

Design of sustainable public buildings is discussed in Chapter 3. The chapter begins with building design by Building Information Modelling (BIM) – an advanced method of working and collaborating digitally in a building project, and is followed by design of load bearing structures based on Eurocode 5. Further the most important issues in assuring adequate moisture performance and fire safety are discussed and possible solutions by using different products are provided.

As lightweight timber structures do not have high acoustic performance at low frequencies, it is essential to stop the spread of vibrations in order to control noise transmission. Three types of solutions – containing resilient profiles, soundproofing layers and sealing products are discussed and illustrated by sample products developed by the Italian company *Rothoblaas*.

At the end of the chapter design of building service system is presented. Breakthroughs in wet rooms are reviewed and problems of condensation from installations. In connection with the increased focus on new timber building

materials, the section also addresses some of the challenges to be aware of in installations and guideways, that can have a major impact on the building design and also over the life of the building.

Chapter 4 provides general information about management and leadership in a construction project. It starts with the definition of project and notion that construction project management requires a wide range of skills. Further main construction project stages are discussed and illustrated by examples of wooden public buildings.

In Chapter 4, differences between management and leadership are noted and safety and quality management principles are included. Guidelines how to make a construction schedule are presented.

Chapter 5 continues the discussion on construction project management in the specific area of wooden construction process management. Typical wooden construction solutions are provided, specifics of quality assurance in wooden construction in situ are described. The chapter also includes construction process management guide, based on the guide prepared by the project called “Value-creating Construction Process” in Denmark and finishes with process management in timber construction based on Finnish experiences.

Following the life cycle of construction, Chapter 6 presents use and maintenance phase of wooden buildings. Fundamentals of building use and maintenance are presented at the beginning and are followed by use of digital technologies in real estate management illustrated with examples on renovation of wooden buildings. Data base for management purposes and maintenance management plan, including examples, is discussed in detail. Final sections include maintenance and repair solutions for wooden buildings and discussion on common reasons of failures in wooden construction, including some possible preventive actions.

Chapter 7 presents some examples of wooden public buildings in different countries.

This handbook is the result of joint investigations of researchers from Vilnius Gediminas Technical University (Lithuania), VIA University College (Denmark), Coventry University (United Kingdom), Häme University of Applied Sciences (Finland) and Riga Technical University (Latvia).

The content of this handbook is related to the Pub-Wood Project and reflects only the authors’ view. The National Agency and the Commission are not

responsible for any use that may be made of the information it contains.

The handbook is published under Creative Commons licence CC BY-NC. This license allows re-users to distribute, remix, adapt, and build upon the material in any medium or format for non-commercial purposes only, and only so long as attribution is given to the creator.





# Chapter 1

## Sustainable Development and Wooden Construction

### **1.1. Understanding the Concept of Sustainable Development**

*Loreta Kanapeckiene, Jurga Naimaviciene, Simona Krasauskiene*

### **1.2. Sustainable Construction**

*Laura Tupenaite, Loreta Kanapeckiene, Jurga Naimaviciene,  
Simona Krasauskiene*

### **1.3. Sustainable Construction in Wood**

*Roger Howard Taylor, Laura Tupenaite, Carl Mills, Araz J. Agha*

### **1.4. Sustainable Building Rating Systems**

*Carl Mills, Araz J. Agha, Laura Tupenaite, Simona Krasauskiene*

### **References**

## 1.1. UNDERSTANDING THE CONCEPT OF SUSTAINABLE DEVELOPMENT

---

**Loreta Kanapeckiene,**

Department of Construction Management and Real Estate,  
Vilnius Gediminas Technical University

**Jurga Naimaviciene,**

Department of Construction Management and Real Estate,  
Vilnius Gediminas Technical University

**Simona Krasauskiene,**

Study and Consulting Center

---

### 1.1.1. History of Sustainable Development

---

According to Bac (2008), the first questions regarding what impact the evolution of civilization could have on the environment and resources of our planet arose approximately 200 years ago. The discussion regarding whether the capacity of the Earth's limited natural resources would be able to continually support the existence of the increasing human population gained prominence with the Malthusian population theory in the early 1800s (Mensah, 2019). Thomas Robert Malthus (1766–1834) was a demographer, political economist and country pastor in England. In his famous publication *An Essay on the Principle of Population* (Malthus, 1978), he predicted that the world's population would eventually starve or, at the least, live at a minimal level of subsistence because food production could not keep pace with the growth of population (Bac, 2008). This postulation tended to be ignored for a long time in the belief that technology could be developed to solve such problems, but debates about Malthusian assumptions have continued. With time, global concerns heightened about the non-renewability of some natural resources which threaten production and long-term economic growth resulting from environmental degradation and pollution (Paxton, 1993, cit.



from Mensah, 2019).

The first truly international conference devoted exclusively to environmental issues was the 1972 Conference on the Human Environment in Stockholm, Sweden. It was attended by 113 states and representatives from 19 international organizations (Bac, 2008). There, a group of 27 experts defined the links between environment and development stating that “although in individual instances there were conflicts between environmental and economic priorities, they were intrinsically two sides of the same coin” (Vogler, 2007, p. 432, cit. from Bac, 2008). Another important result of the conference was the development of the *United Nations Environmental Programme* (UNEP) with the mission “to provide leadership and encourage partnership in caring for the environment by inspiring, informing, and enabling nations and peoples to improve their quality of life without compromising that of future generations”.

The conference played a catalytic role in promoting the subsequent adoption of international agreements concerned with ocean dumping, pollution from ships, and the endangered species trade. It also adopted the *Stockholm Declaration on the Human Environment*, which included forward-looking principles, such as Principle 13, that declared the need for integration and coordination in development planning to allow for environmental protection (Bac, 2008).

In 1983, the UN General Assembly created the World Commission on Environment and Development which was later known as the Brundtland Commission, named after its Chair, Gro Harlem Brundtland, then Prime Minister of Norway and later Head of the World Health Organization (Bac, 2008). In 1987, the Commission published the Brundtland Report, entitled *Our Common Future*. It provided the definition of sustainable development: “sustainable development is development that meets the needs of the present without compromising the ability of future generations to meet their own needs” (World Commission on Environment and Development, 1987). Central to the Brundtland Commission Report were two key issues: the concept of needs, in particular the essential needs of the world’s poor (to which overriding priority should be given); and the idea of limitations imposed by the state of technology and social organisation on the environment’s ability to meet present and future needs (Kates et al., 2001, cit. from Mensah, 2019). Some critics called the Brundtland’s Commission Report both optimistic and vague, but the fact still remains that the concept of sustainable development was born (Bac, 2008).

Further the UN Conference on the Environment and Development (UNCED) in Rio de Janeiro, Brazil, during the summer of 1992 was held. It is known an unprecedented historical event with the largest gathering of 114 heads of state, including 10,000 representatives from 178 countries and 1400 nongovernmental organizations represented by additional thousands. The key outputs of the Conference were: the Rio Declaration, Agenda 21, and the Commission on Sustainable Development (Bac, 2008).

Agenda 21 articulated the commitment of leaders from around the world to sustainable development by a 500-page collection of agreed healthy practices and advices for achieving sustainable development. Agenda 21 activities were organized under environmental and development themes: quality of life, efficient use of natural resources, protection of the global commons, management of human settlements, and sustainable economic growth. During the 1992 conference it was agreed that to implement Agenda 21, countries should prepare a national sustainable development strategy (Bac, 2008).

In the 1997 Kyoto conference on climate change, developed countries agreed on specific targets for cutting their emissions of greenhouse gases, resulting in a general framework, which became known as the Kyoto Protocol, with specifics to be detailed over the next few years (Bac, 2008). The USA proposed to stabilize emissions only and not cut them at all, while the European Union called for a 15 % cut. In the end, there was a trade off, and industrialized countries were committed to an overall reduction of emissions of greenhouse gases to 5.2 % below 1990 levels for the period 2008–2012. Although 84 countries signed the Protocol, indicating their intent to ratify it, many others were reluctant to take even this step. The USA has refused to ratify the Kyoto Protocol. The Kyoto Protocol still remains one of the most debated international agreements between the ‘greens’ and the ‘neo-liberals’ (Bac, 2008).

In September 2000 at the Millennium Summit held in New York, world leaders agreed on the Millennium Development Goals, most of which had the year 2015 as a timeframe and used 1990 as a benchmark. They included: 1) halving the proportion of people living on less than a dollar a day and those suffering from hunger, 2) achieving universal primary education and promoting gender equality, 3) reducing child mortality and improving maternal health, 4) reversing the spread of HIV/AIDS, 5) integrating the principles of sustainable development into country policies, 6) reducing by

half the proportion of people without access to safe drinking water (Bac, 2008).

Next important event was The World Summit on Sustainable Development (WSSD) which took place in Johannesburg in 2002. The Johannesburg Summit reconfirmed the Millennium goals and complemented them by setting a number of additional ones such as halving the proportion of people lacking access to basic sanitation; minimizing harmful effects from chemicals; and halting the loss of biodiversity (Bac, 2008).

The Johannesburg Conference confirmed a trend, which appeared since the 1992 Conference, of the increasing importance of the socioeconomic pillars of sustainable development. The environmental agenda at the two previous UN conferences had been sustained by peaks in the public ‘attention cycle’ of major developed countries. WSSD incorporated the concept of sustainable development throughout its deliberations and was initially dubbed ‘the implementation summit’. Inevitably “demands for additional financial resources and technology transfer continued, but much of the debate had already been pre-empted by the establishment of the Millennium Development Goals in 2000” (Vogler, 2007, p. 439, cit. from Bac, 2008).

In 2012, 20 years after the first Rio Earth Summit, the United Nations Conference on Sustainable Development (UNCSD) or Rio+20 was held. The conference focused on two themes in the context of sustainable development: green economy and an institutional framework (Allen et al., 2018, cit. from Mensah, 2019). Outcomes of Rio+20 included a process for developing new sustainable development goals (SDGs), to take effect from 2015 and to encourage focused action on sustainable development in all sectors of global development agenda (Weitz et al., 2017, cit. from Mensah, 2019).

In 2015 the new 2030 Agenda for Sustainable Development was introduced with the 17 SDGs and 169 targets which demonstrate the scale and ambition of the new universal Agenda. They are integrated and indivisible and balance the three dimensions of sustainable development: the economic, social and environmental.

The Goals and targets will stimulate action over the next fifteen years in areas of critical importance for humanity and the planet (see Fig. 1.1) (UN, 2015):

1. **People:** To end poverty and hunger in all their forms and dimensions, and to ensure that all human beings can fulfil their potential in dignity and equality and in a healthy environment.
2. **Planet:** To protect the planet from degradation, including through sustainable consumption and production, sustainably managing its natural resources and taking urgent action on climate change, so that it can support the needs of the present and future generations.
3. **Prosperity:** To ensure that all human beings can enjoy prosperous and fulfilling lives and that economic, social and technological progress occurs in harmony with nature.
4. **Peace:** To foster peaceful, just and inclusive societies which are free from fear and violence. There can be no sustainable development without peace and no peace without sustainable development.
5. **Partnership:** To mobilize the means required to implement the Agenda through a revitalized Global Partnership for Sustainable Development, based on a spirit of strengthened global solidarity, focused in particular on the needs of the poorest and most vulnerable and with the participation of all countries, all stakeholders and all people.



**Fig. 1.1.** Critical areas of sustainable development (UN, 2015).

## 1.1.2. Key Pillars of Sustainable Development

The three main issues of sustainable development are economic growth, environmental protection and social equality, therefore the concept of sustainable development rests on three key pillars, namely economic sustainability, social sustainability, and environmental sustainability (see Fig. 1.2).

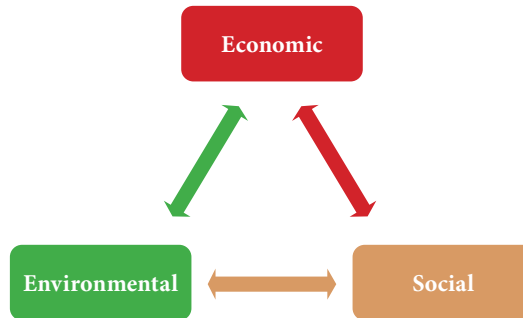


Fig. 1.2. Key pillars of sustainability.

### Economic sustainability

Economic sustainability implies a system of production that satisfies present consumption levels without compromising future needs (Lobo et al., 2015). In other words, economic sustainability refers to practices that support long-term economic growth without negatively impacting social, environmental, and cultural aspects of the community (University of Mary Washington, n.d.).

There are couple of explanations of economic sustainability. The differences between two of these are due to the use of different sustainability models as a starting point. In the first of these two explanations, economic sustainability is understood to be economic development that does not have a negative impact on ecological or social sustainability. An increase in economic capital must therefore not be at the expense of a reduction in natural capital or social capital (KTH, n.d.).

In the second explanation, economic sustainability is equated with economic growth, which is considered sustainable as long as the total amount of capital increases. Increased economic capital can thus be allowed at the expense of



a reduction of other assets in the form of natural resources, ecosystem services or welfare (KTH, n.d.).

No one these days seriously denies the need for sustainable business practices. Even those concerned about only business and not the fate of the planet recognize that the viability of business itself depends on the resources of healthy ecosystems – fresh water, clean air, robust biodiversity, productive land – and on the stability of just societies (Chouinard et al., 2011).

## **Social sustainability**

---

Since development is about people, the people matter (Benaim & Raftis, 2008). Social sustainability encompasses notions of equity, empowerment, accessibility, participation, cultural identity and institutional stability (Daly, 1992). The social sustainability dimension largely concerns well-being, justice, power, rights and the needs of the individual (KTH, n.d.).

An individual has needs, physical and psychological, and own goals / dreams. Meeting the ability of the planet and all of the people to fulfil these at a global level is what social sustainability deals with. In this process, concepts such as justice, power, rights and trust become central to guiding to human constellations that allow to achieve full potential (KTH, n.d.).

According to the United Nations Global Compact (n.d.), from the viewpoint of business, “social sustainability is about identifying and managing business impacts, both positive and negative, on people. The quality of a company’s relationships and engagement with its stakeholders is critical”.

The first six of the UN Global Compact’s principles focus on this social dimension of corporate sustainability, of which human rights is the cornerstone. Social sustainability also covers the human rights of specific groups: labour, women’s empowerment and gender equality, children, indigenous peoples, people with disabilities, as well as people-centered approaches to business impacts on poverty. As well as covering groups of rights holders, social sustainability encompasses issues that affect them, for example, education and health (UN Global Compact, n.d.).

While it is the primary duty of governments to protect, respect, fulfil and progressively realize human rights, businesses can, and should, do their part. At a minimum, businesses can undertake due diligence to avoid harming

human rights and to address any adverse impacts on human rights that may be related to their activities (UN Global Compact, n.d.).

According to Kolk (2016, cit. from Mensah, 2019) social sustainability is not about ensuring that everyone's needs are met. Rather, it aims at providing enabling conditions for everyone to have the capacity to realize their needs, if they so desire.

## Environmental sustainability

---

The concept of environmental sustainability (sometimes called ecological sustainability) is about the natural environment and how it remains productive and resilient to support human life (Mensah, 2019). Environmental sustainability relates to ecosystem integrity and carrying capacity of natural environment (Brodhag & Taliere, 2006). The implication is that natural resources must be harvested no faster than they can be regenerated, while waste must be emitted no faster than they can be assimilated by the environment (Diesendorf, 2000, cit. from Mensah, 2019).

Amongst other things, ecological sustainability relates to the functioning of the Earth's biogeochemical system, which includes the following (KTH, n.d.):

- water (pollutants, groundwater levels, salinity, temperature, alien species);
- air (pollutants, particles, ozone layer, climate system, noise);
- land (pollutants, erosion, land use, alien species);
- biodiversity (species and habitats (natural habitats), GMOs);
- ecosystem services (e.g., pollination, photosynthesis, water purification, climate control).

Ecological sustainability sometimes also includes human health, to the extent that it is affected by the external environment in terms of pollutants, noise, etc. (KTH, n.d.).

Climate change has already shown signs of affecting biodiversity. In particular, Kumar et al. (2014) have observed that higher temperatures tend to affect the timing of reproduction in animal and plant species, migration patterns of animals and species distributions and population sizes. According to Campagnolo et al. (2018), for the sake of sustainability, all societies must adjust to the emerging realities with respect to managing ecosystems and natural limits to growth.

## 1.2. SUSTAINABLE CONSTRUCTION

***Laura Tupenaite,***

Department of Construction Management and Real Estate,  
Vilnius Gediminas Technical University

***Loreta Kanapeckiene,***

Department of Construction Management and Real Estate,  
Vilnius Gediminas Technical University

***Jurga Naimaviciene,***

Department of Construction Management and Real Estate,  
Vilnius Gediminas Technical University

***Simona Krasauskiene,***

Study and Consulting Center

In many countries construction has been identified as the first sector to require specific attention in meeting the sustainable development agenda. As noted in report *Shaping the Future of Construction – A Breakthrough in Mindset and Technology* (World Economic Forum, 2016), the industry is crucial to society, the economy and the environment.

Construction is one of the first businesses that humankind developed, and it continues to shape our daily life in unique ways. Virtually all other businesses rely on the construction industry to provide and maintain their accommodation, plants and infrastructure, and construction is a determinant of where and how almost everyone lives, works and plays. For nearly the entire population of the world, the built environment heavily influences quality of life (World Economic Forum, 2016). In the United States, for instance, people on average spend nearly 90 % of their time indoors. So, the building and the materials used in its construction and finishing have a major impact on the health and well-being of its occupants (World Economic Forum, 2016). The industry is the key to the quality of life, as it produces the built environment and puts in place the physical facilities and infrastructure that determine the degree of freedom and flexibility that society may enjoy. Its products also have a long lifetime, typically for anything up to one hundred years after construction (Myers, 2013).

The construction industry is a vitally important industry for global economy. With total annual revenues of almost \$10 trillion and added value of \$3.6 trillion, the construction industry accounts for about 6 % of global GDP. More specifically, it accounts for about 5 % of total GDP in developed countries, while in developing countries it tends to account for more than 8 % of GDP. More than 100 million people are employed in construction worldwide (World Economic Forum, 2016).

For countries to enjoy inclusive and sustainable growth, modern and efficient infrastructure is essential. According to a 2014 estimate by the International Monetary Fund (2014), if advanced economies invested an extra 1 % of GDP into infrastructure construction, they would achieve a 1.5 % increase in GDP after four years.

As Myers (2013) notes, construction is consistently responsible for some of the most profound negative impacts – the construction industry consumes more raw materials than any other industrial sector and is responsible for a significant proportion of the world's waste and carbon dioxide emissions.

The construction industry is the single largest global consumer of resources and raw materials. It consumes about 50 % of global steel production and, each year, 3 billion tonnes of raw materials are used to manufacture building products worldwide (World Steel Association, 2015).

About 40 % of solid waste in the United States derives from construction and demolition (Environmental and Energy Study Institute, 2014). Throughout the world, such waste involves a significant loss of valuable minerals, metals and organic materials – so there is great opportunity to create closed material loops in a circular economy (World Economic Forum, 2016).

As for energy use, buildings are responsible for 25–40 % of the global total, thereby contributing hugely to the release of carbon dioxide (World Economic Forum, 2016).

Finally, construction lacks change and innovations. In nearly every other sector of the economy, technological developments have fueled changes in business attitudes. For example, the manufacturing industry has become leaner, cleaner and quicker at all tasks. On the other hand, the construction industry is old fashioned. It suffers from inertia. It is a market of few large players and many small businesses. The owners of these businesses look for job opportunities in their local areas and are not inclined to invest time or money into research and development (Myers, 2013).

The notion of sustainability, therefore, has a special relevance to construction, and a specific agenda is evolving. The construction industry’s response to sustainable development is *sustainable construction* (Bourdeau, 1999).

In 1994, the first definition of sustainable construction was given by Professor Charles J. Kibert during the Final Session of the First International Conference of CIB TG 16 on Sustainable Construction as “the creation and responsible management of a healthy built environment based on resource efficient and ecological principles” (Kibert, 1994).

Kibert (1994), compared with the traditional concerns in construction (performance, quality, cost), introduced the criteria of sustainable construction, namely resource depletion, environmental degradation and healthy environment (see Table 1.1).

Table 1.1  
Traditional and Sustainability Criteria  
for Building Materials, Products, and Systems (Kibert, 1994)

Traditional Criteria	Sustainability Criteria
<ul style="list-style-type: none"> <li>● Performance</li> <li>● Cost</li> <li>● Quality</li> </ul>	<ul style="list-style-type: none"> <li>● Resource depletion</li> <li>● Environmental degradation</li> <li>● Healthy environment</li> </ul>

Kibert (1994) also introduced six principles set for sustainable construction (see Table 4.2) and a conceptual model (see Fig. 1.3).

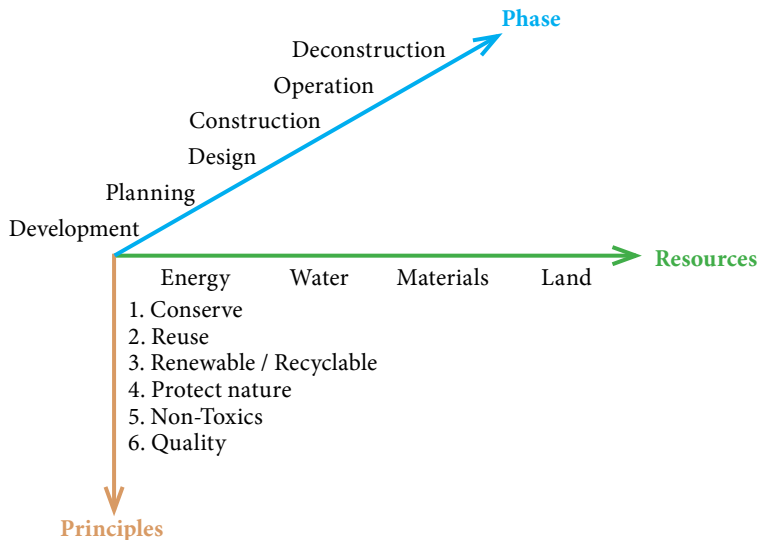


Fig. 1.3. A conceptual model for sustainable construction (Kibert, 1994).



Table 1.2  
Principles Set for Sustainable Construction (Kibert, 1994)

Principle	Description
Minimize resource consumption (Conserve)	It is the starting principle because it contrasts the major problem that forces us to address sustainability in the first place: overconsumption. It leads us to the use of passive measures to provide heating, cooling, ventilation, and lighting for our structures because the minimization of energy consumption is absolutely essential. It forces us to consider high efficiency systems, high levels of insulation, low flow fixtures, and high-performance windows. It also leads us to the use of durable materials that have long lifetimes and require low maintenance.
Maximize resource reuse (Reuse)	Reuse contrasts to recycling in that reused items are simply used intact with minimal reprocessing, while recycled items are in essence reduced to raw materials and used in new products. A significant business in architectural items such as windows, doors, and bricks that can be reused in new construction and renovation has proven to be profitable, as owners and architects strive to recapture a sense of the past in new spaces. Other resources such as water can be reused via use of grey water systems and use of third main systems. Land can be used by creating new spaces in 'grey zones', areas formerly used for buildings.
Use renewable or recyclable resources (Renew / Recycle)	This principle applies to energy where renewable sources such as solar and wind power are available for use. It applies to materials such as wood. This common construction material can be supplied from certified sustainable forests that provide the buyer with a reasonable level of assurance that the suppliers are managing their resources in a manner that protects the environment. A wide range of materials have recycled or waste content from engineered wood systems, agriboard panels, tiles with recycled tire or glass content, roofing shingles made of recycled plastics, and many others. One of the problems that must be sorted out with respect to recycled materials is to determine if their content is simply convenient waste from other industries or bona fide recycled content. Products that consist of the former may be said to be down cycled or cascaded uses with the built environment serving as a convenient dumping ground for otherwise difficult to dispose of materials.

Principle	Description
Protect the natural environment (Protect nature)	Inevitably our actions in creating the built environment will impact the natural environment and its ecological systems. Considering the past negative effects on the natural environment, perhaps it is time to do better than just 'sustain', and to 'restore' where possible. Grey zones can be remediated, detoxified and returned nearly to their original state. The abuses of river straightening, marsh draining, and deforestation can be remedied by intelligent intervention in creating the future built environment. In our quest for materials we can scrutinize the impacts of materials acquisition practices, whether logging, mining, or consuming energy, to minimize environmental effects. Some of the choices are not easy but will inevitably be forced on us by global environmental effects, scarcity, or other reasons.
Create a healthy, non-toxic environment (Non-Toxics)	The outcome of this principle in a practical sense is the elimination of toxics in the indoor and exterior built environment. One of the major objectives is to achieve good indoor air quality by selecting materials that will not off-gas or contribute particulate loading to the environment. Relative to the exterior environment, landscape design should provide for the use of plants and vegetation that are hardy, drought tolerant, and insect resistant. These qualities are usually provided by vegetation native to the region. Using this so-called 'xeriscaping' strategy will minimize and perhaps eliminate the application of pesticides, herbicides, fungicides, and fertilizers that ultimately end up polluting groundwater.
Pursue quality in creating the built environment (Quality)	Although often cited and equally often abused, the notion of quality as a component of sustainable construction is vital. It includes planning of communities to reduce automobile trips, increase interpersonal activity, and provide a good quality of life. It includes excellence in design of buildings as an absolutely essential component of sustainable construction because spaces that are not valued by their occupants will, by their very nature, fall into disuse, disrepair, and disorder, contributing to the exact antithesis of what sustainability strives to achieve. Selection of materials, energy systems, design of passive energy and lighting systems, and a host of other decisions rest on the idea that significant analysis and design are required to lay out spaces, build spaces, and occupy them.

Since establishment of a model much progress to sustainable construction has been made all over the world. The International Council for Research and Innovation in Building and Construction (CIB) has carried out a study aimed to compare the vision of sustainable construction in different countries.

The study revealed that sustainable construction has different approaches and different priorities in different countries. Some of them identify economic, social and cultural as part of their sustainable construction framework, but it is raised as a major issue in a few countries only (see Table 1.3).

Table 1.3

Countries Following a Sustainable Construction Agenda (Myers, 2013)

Three-strand policy (three sustainability pillars)	Environmental strand (one sustainability pillar)
Denmark	Australia
Finland	Canada
France	Germany
Ireland	USA
Japan	
Netherlands	
Norway	
Portugal	
Sweden	
United Kingdom	

The main emphasis in national definitions is on ecological impacts to the environment (biodiversity, tolerance of nature and resources). The categories of problems identified behind the notion of sustainable construction can also be classified as follows (Bourdeau, 1999):

- physical problems linked to the issue of resources;
- biological problems linked to the life of mankind;
- sociological problems having socio-political;
- socio-economic or socio-cultural facets.

Nowadays precise definitions of sustainable construction vary from place to place and are constantly evolving to encompass varying approaches and priorities.

In the United States, the Environmental Protection Agency (EPA) defines green construction as “the practice of creating structures and using processes that are environmentally responsible and resource-efficient throughout a building’s life-cycle from siting to design, construction, operation, maintenance, renovation and deconstruction”. Green building is also known as a sustainable or high-performance building. Green buildings are designed to reduce the overall impact of the built environment on human health and the natural environment by (EPA, 2019):

- efficiently using energy, water, and other resources;
- protecting occupant health and improving employee productivity;
- reducing waste, pollution and environmental degradation.

European Commission [EC] defines sustainable construction as “a dynamic of developers of new solutions, investors, the construction industry, professional services, industry suppliers and other relevant parties towards achieving sustainable development”. It embraces a number of aspects such as design and management of buildings and constructed assets, choice of materials, building performance as well as interaction with urban and economic development and management. Different approaches may be followed according to the local socio-economic context; in some countries, priority is given to resource use (energy, materials, water, and land use), while in others social inclusion and economic cohesion are the more determining factors (EC, 2016).

Sustainable buildings combine improved energy performance and reduced environmental impact throughout their life cycle. Their users enjoy better health and well-being and productivity gains that translate into cost savings. Buildings have the potential to reach a 90 % reduction of their greenhouse gas emissions by 2050 (EC, 2016).

Three interpretations of what sustainable construction has involved in practice in Europe are shown in Table 1.4. The key ideas that recur in these definitions are to minimize the amount of energy and resources used in the construction process, reduce the amount of waste and pollution, and to respect the various stakeholders – particularly the users – both now and in the future (Myers, 2013).

Table 1.4  
Three Interpretations of Sustainable Construction (Myers, 2013)

Country	Interpretation of sustainable construction
Finland, since 1998	<ul style="list-style-type: none"> <li>● Intensified energy efficiency &amp; extensive utilisation of renewable energy resources</li> <li>● Increasing the sense of well-being over a prolonged service life</li> <li>● Saving of natural resources and promotion of the use of by-products</li> <li>● Reducing waste and emissions</li> <li>● Recycling building materials</li> <li>● Supporting the use of local resources</li> <li>● Implementation of quality assurance and environmental management systems</li> </ul>
The Netherlands, since 1999	<ul style="list-style-type: none"> <li>● Consume a minimum amount of energy and water over the life span</li> <li>● Make efficient use of raw materials</li> <li>● Generate a minimum amount of pollution and waste</li> <li>● Use a minimum amount of land and integrate well with the natural environment</li> <li>● Meet user needs now and in the future</li> <li>● Create a healthy indoor environment</li> </ul>
United Kingdom, since 2000	<ul style="list-style-type: none"> <li>● Minimizing the consumption of carbon-based energy</li> <li>● Improving whole life value by supporting best practice construction</li> <li>● Delivering buildings and structures that provide greater satisfaction,</li> <li>● Well-being and value to customers and users</li> <li>● Respecting and treating stakeholders more fairly</li> <li>● Enhancing and better protecting the natural environment</li> <li>● Being more profitable and using resources more efficiently</li> </ul>

Summary of definitions reflects in sustainable construction understanding provided by Myers (2013): “Sustainable construction means designing, renovating or converting a building in compliance with environmental rules and energy-saving methods. The purpose of this holistic process is to restore and maintain harmony between the natural and built environment:

- efficient use of resources;
- efficient protection of the environment;
- economic growth;
- social progress that meets the needs of everyone”.

According to Myers (2013), in practical terms, sustainable construction can be reduced to three important messages for the way the industry should work:

- Buildings and infrastructure projects should become more cost effective to produce and run because they have been constructed with less and yield more.
- Construction projects should contribute positively to their environment by using materials and systems that are easily replenished over their full life cycle.
- Contractors and clients should, wherever possible, create higher standards of respect for people and communities involved with the project, from the site workers through to the final community of users.

## 1.3. SUSTAINABLE CONSTRUCTION IN WOOD

---

**Roger Howard Taylor,**

VIA University College

**Laura Tupenaite,**

Department of Construction Management and Real Estate,  
Vilnius Gediminas Technical University

**Carl Mills,**

School of Energy, Construction and Environment, Coventry University

**Araz J. Agha,**

School of Energy, Construction and Environment, Coventry University

---

Wood's millennial history as building material makes it one of the oldest building materials we have. Since the dawn of civilization, timber has been used as a material to construct shelters protecting human from the severe weather conditions and predators. The use of timber in construction dates back to 500 to 100 B.C., which was structurally used in roof constructions by the ancient Roman and Egyptian civilizations that majorly used stone in buildings (Radkau, 2012). In comparison, steel has only been used for buildings since the 1880s and modern concrete since the 1850s. It may therefore seem paradoxical that wood is not selected as major material for construction of public buildings due to lack of experience with wood compared to steel and concrete. The explanation is, among other things, that the large industrial-processed solid wooden elements are relatively a new invention. For example, CLT (Cross-Laminated Timber) was first introduced in the 1980s, and the experience base for wood construction is only being established. However, in Europe and North America, the number of projects in wood in recent years has been rising exponentially. For instance, Moxy hotel in Copenhagen was recently opened, which is the first Danish hotel built with cross-laminated timber (Fig. 1.4).



Fig. 1.4. Moxy hotel in Copenhagen (Hospitalitynet, 2020).

### 1.3.1. Modern Building Methods in Wood

---

There is a wealth of possibilities for the choices of building materials, from wood products to concrete. The high quality of wood material allows for the production of a wide range of products adapted to the current areas of application. The wood construction sector is also extensively regulated and specified in the European standardisation system, which ensures great geographic mobility and competition.

No matter what building materials or methods are implemented, it is important to use the materials so that their best properties are utilized for the project in question. This means that it often makes sense to use materials in hybrid constructions, e.g. in combination with other materials. It must be ensured that the solutions are designed so that materials and components fit well together for example in moisture-sensitive areas and construction movements, etc. (InnoBYG, 2017).

There are several different building systems, where requirements for span, strength and stability are crucial for the choice of materials and components, but often there will be many useful building solutions for each task. Further is a short presentation of some selected building systems for construction of wooden buildings.



## Prefabricated wood elements

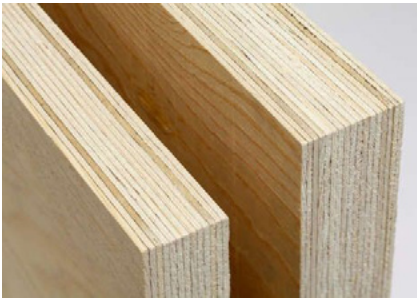
Prefabricated wood elements are typically constructed of studs of construction wood. The studs are typically placed with a spacing of 50–60 cm depending on the strength and rigidity requirements. The elements also can be of glued laminated timber (glulam) or laminated veneer lumber (LVL).

Glued laminated timber, also called glulam, is the oldest glued structural product (over 100 years). It is generally composed of lumber layers (2×3 to 2×12), planed and pre-finger-jointed, and then bonded together with moisture-resistant structural adhesives longitudinally (Avellan, 2018; Quebec Wood Export Bureau [QWEB], 2015) (Fig. 1.5). Large straight or curved sections can be produced, providing more stability than heavy lumber. Glulam can be used for columns, beams, or arches, in lengths mainly limited because of transport.

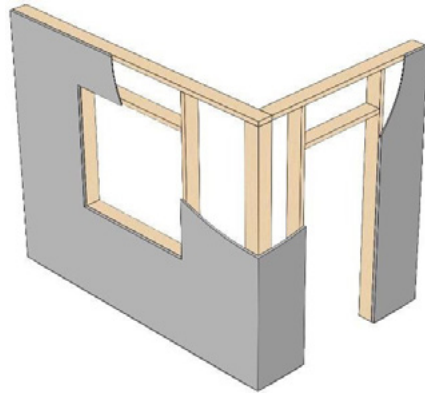
Laminated veneer lumber (LVL) is an engineered wood product made up with thin dried wood and bonded with adhesive (Avellan, 2018) (Fig. 1.6). It can be used for beams, walls, other structures and forming of edges. LVL is a type of structural composite lumber. Due to its composite nature, it is much less likely than conventional lumber to warp, twist, bow, or shrink, and has higher allowable stress



**Fig. 1.5.** Glue laminated timber (Instabuilt, n.d.).



**Fig. 1.6.** Laminated veneer lumber (Metsä Wood's Kerto-Qp, n.d.).



**Fig. 1.7.** Principle drawing of prefabricated wood elements (InnoBYG, 2017).

compared to glulam (QWEB, 2015).

The elements are covered with a windbreak, damp-proof membrane (DPM), and exterior and interior cladding (Fig. 1.7). Prefabricated wood elements can be made in a factory, as a flat element or as room size, volume elements with finished interior fitting. The prefabrication element types are determined by the needs of the individual building. It will often be the transport considerations that set the limits for the size of elements that can be manufactured.

Prefabricated wood elements can be used for walls, deck and roof elements. They can be designed as infill panels or as fully or partially load-bearing and / or stabilizing building elements.

## Solid wood elements

---

Massive wooden elements in the ‘modern’ form have been known and used since the late 80s. Over the last 20 years, the development of solid wood elements has shifted to Cross Laminated Timber elements (CLT).

CLT is a solid engineered wood panel made up of cross angled timber boards which are glued (Avellan, 2018) (Fig. 1.8). It distinguishes from other products by superior thermal and acoustical performance, high fire resistance and structural strength (QWEB, 2015).

The CLT development has taken place in the Middle East and especially in Austria, Switzerland and Southern Germany. In Denmark the growth of the use of solid wood elements in the late 90s and early 00s, where several buildings using these elements saw the light of the day.

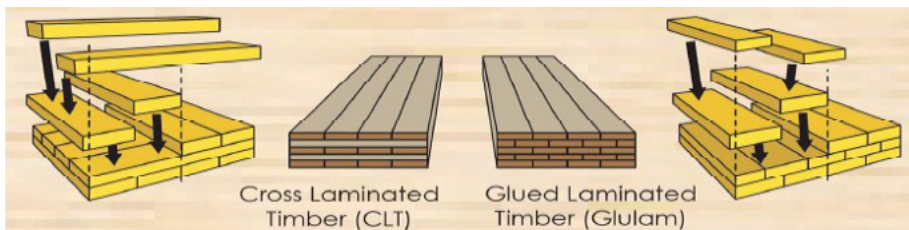
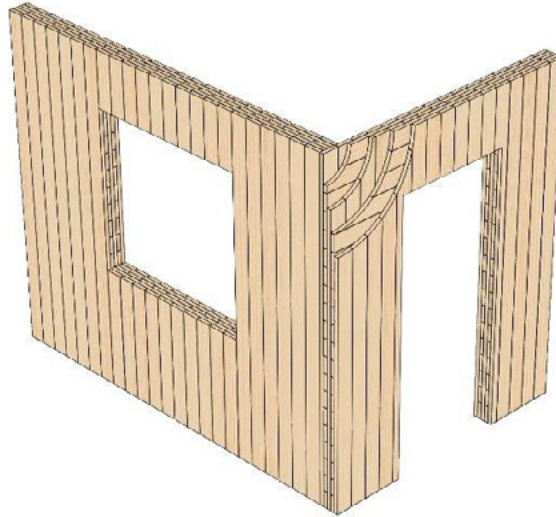


Fig. 1.8. Difference between CLT and glulam (Avellan, 2018).

Unlike the stud frame building, the massive CLT constructions have some clear advantages, for example in connection with load distribution and minimization of risk of progressive collapse (Fig. 1.9). CLT elements can be used as wall, deck or roof elements and may be included as fillers or as fully or partially bearing and / or stabilizing building elements in the building. For the heat and sound insulation, solid wood elements must be supplied with insulation to meet the requirements of the building regulations.



**Fig. 1.9.** Principle drawing of CLT elements (InnoBYG, 2017).

In recent years, existing European producers have delivered CLT to most of the world. North America now has its own production which will have an impact on European exports. For example, Structrelam in British Columbia, Canada, has delivered CLT elements to the Brock Commons in Vancouver (InnoBYG, 2017).

A common European standard for solid wood elements – EN 16351:2015, has been adopted at European level. The standard is an official journal, which is the prerequisite for the CE marking of the products in accordance with the standard. However, there are a number of CE-labeled products on the market today. However, these products are CE-labeled on the basis of individual European Assessment Documents (EADs), which in some areas makes it difficult to compare the products. For example, there are no fixed standard classes, as it is known for glulam, which means that several alternative CLT solutions can be considered in individual projects (InnoBYG, 2017).

## Column-beam system and hybrid solutions

---

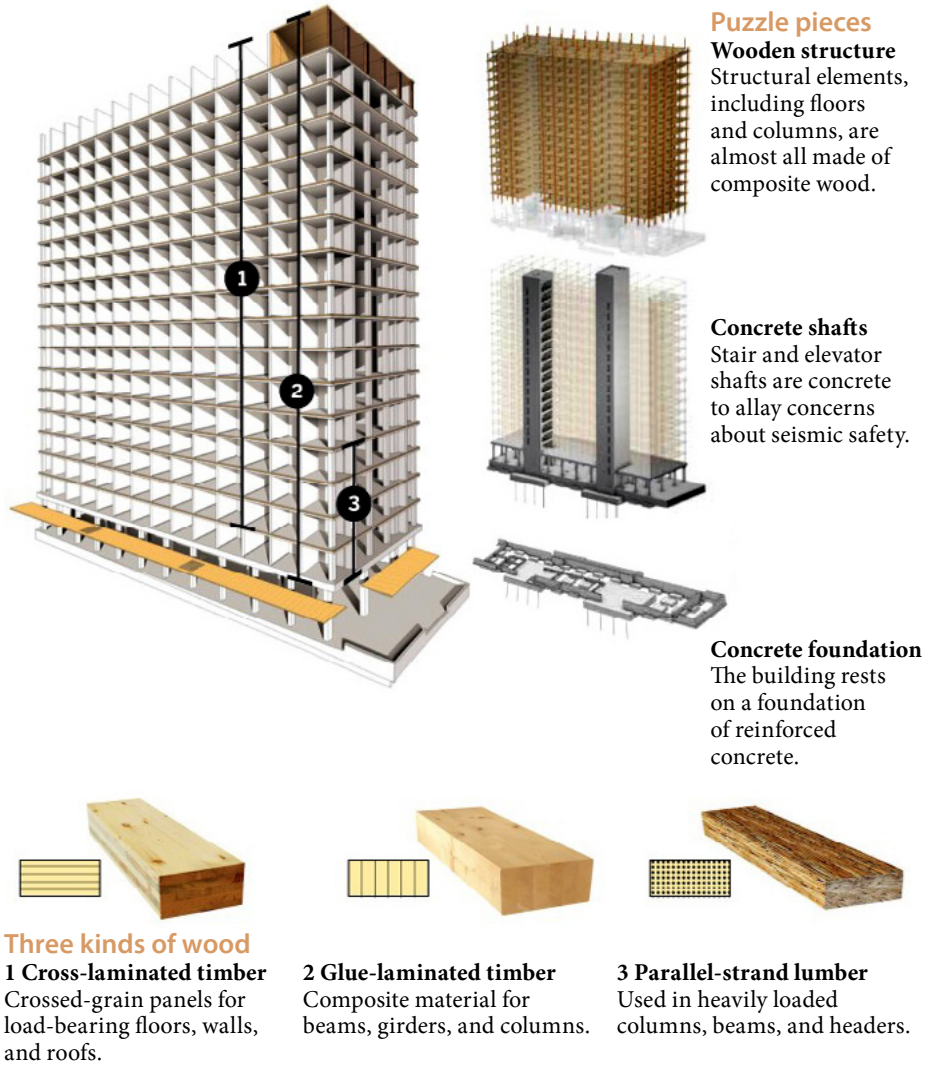
Column-beam systems are also implemented in high-rise wooden buildings. These systems can be constructed of wood products such as glulam and LVL, but can also be carried out in steel frame systems, e.g. with CLT elements or prefabricated wood elements. Systems like these will typically be referred to as hybrid solutions.

In column / beam systems in steel and the wood construction can be used as a fire protection for the steel. Column/ beam systems will form the load bearing super construction, and walls can be infill elements and the decking of load bearing CLT elements.

The many possibilities for wood products, also provide many different combinations within the product range of wooden components (Fig. 1.10). However, it is also possible to combine, for example CLT with concrete and steel in floor partitions in order to optimize the utilization of materials (Fig. 1.11). This allows for greater load bearing spans and increased passive fire resistance (InnoBYG, 2017).



**Fig. 1.10.** Hybrid construction with glulam column and CLT beams. Source: Acron Ostry Architects. Photo: KK Law (cit. from InnoBYG, 2017).



**Fig. 1.11.** Hybrid construction – Brock Commons (University of British Columbia and Acton Ostry Architects Inc., n.d.).

## 1.3.2. Sustainability of Wooden Buildings

---

Recent interest in timber buildings is related to sustainability and other substantial benefits of wood.

### Environmental aspect

---

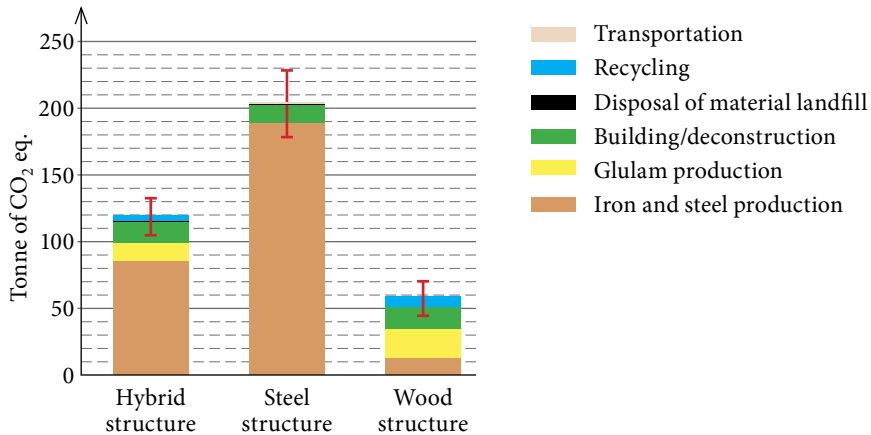
Wood is the only renewable construction material that requires very little energy for its processing (QWEB, 2015). All timber products store carbon. By nature, wood is composed of carbon that is captured from the atmosphere during tree growth. Two effects – substitution and sequestration – create positive carbon impact of timber products (Bergman et al., 2014).

Wood binds CO<sub>2</sub> from the atmosphere as it grows. As a rule of thumb, the tree ‘consumes’ the 1.6-1.8 kg CO<sub>2</sub> per 1 kg of wood it forms. When the tree is broken down by fungi or other natural processes, a corresponding amount of CO<sub>2</sub> is released to the atmosphere again. Similarly, by combustion. But when wood is part of the construction, the building works as carbon sink. For the construction of Moholt 50 in Norway, approx. 5600 m<sup>3</sup> or approx. 2240 tons of solid wood, if we assume a density of 400 kg/m<sup>3</sup>, was used. The construction resulted in a storage of well 3500 tons of CO<sub>2</sub> – or equivalent to almost 2000 average cars annual CO<sub>2</sub> emissions at a driving requirement of 15,000 km/year (InnoBYG, 2017).

However, the most significant part of the CO<sub>2</sub> gain in wood construction is achieved through the substitution gain, which is in the saved consumption, thus saving steel and concrete production. Steel and concrete production is responsible for 9 % and 5 % of the world’s total fossil energy consumption. For the production of 1 ton of concrete and 1 ton of steel, respectively, 87 kg and 1.9 tones CO<sub>2</sub> are emitted. Production of wood, on the other hand, stores CO<sub>2</sub> from the atmosphere itself, including the consumption of fossil fuels in connection (InnoBYG, 2017). Using wood substitutes could save 14 to 31 % of global CO<sub>2</sub> emissions and 12 % to 19 % of global fossil fuel consumption by using 34 to 100 % of the world’s sustainable wood growth (Oliver et al., 2014).

Figure 1.12 presents the result of the carbon footprint of the whole-wood structure in comparison with the hybrid and steel structures by Laurent et al. (2018). The carbon impact of the structure made entirely of wood is lower





**Fig. 1.12.** Wood structure carbon footprint comparison (Laurent et al., 2018).

than the two others, with emissions of the order of 58.6 tons of CO<sub>2</sub>-eq. So, the wooden structure would have emitted only half of the GHG emissions from the real (hybrid) structure and one quarter of the total GHG emissions of the steel structure. The figure shows a distribution of the contribution of the impacts, and results show that the production of glulam has a greater contribution to the wood structure GHG impact (37 %) than steel production with 22 % of the overall GHG impact. This is due to the low amount of steel needed for this structure (Laurent et al., 2018).

The study by Börjesson and Gustavsson (2000) revealed that the primary energy input (mainly fossil fuels) in the production of building materials is about 60–80 % lower for timber frames compared to concrete frames.

Petersen and Solberg (2002) compared the use of glued laminated beams at the Gardermoen airport outside Oslo with an alternative solution to steel. They found that the total energy consumption in manufacturing of steel beams is 2–3 times higher and the use of fossil fuel 6–12 times higher than in the manufacturing of glulam beams. Skullestad et al. (2016) have applied life cycle assessment to compare the climate change impact of a reinforced concrete structure to the climate change impact of an alternative timber structure for 4 buildings ranging from 3 to 21 storeys. According to attributional life cycle assessment results, the timber structures can cause a 34–84 % lower climate change impact than the reinforced concrete structures.

In addition to environmental benefits through CO<sub>2</sub> savings, wooden construction also fits into the mindset of circular economics (Fig. 1.13), e.g.

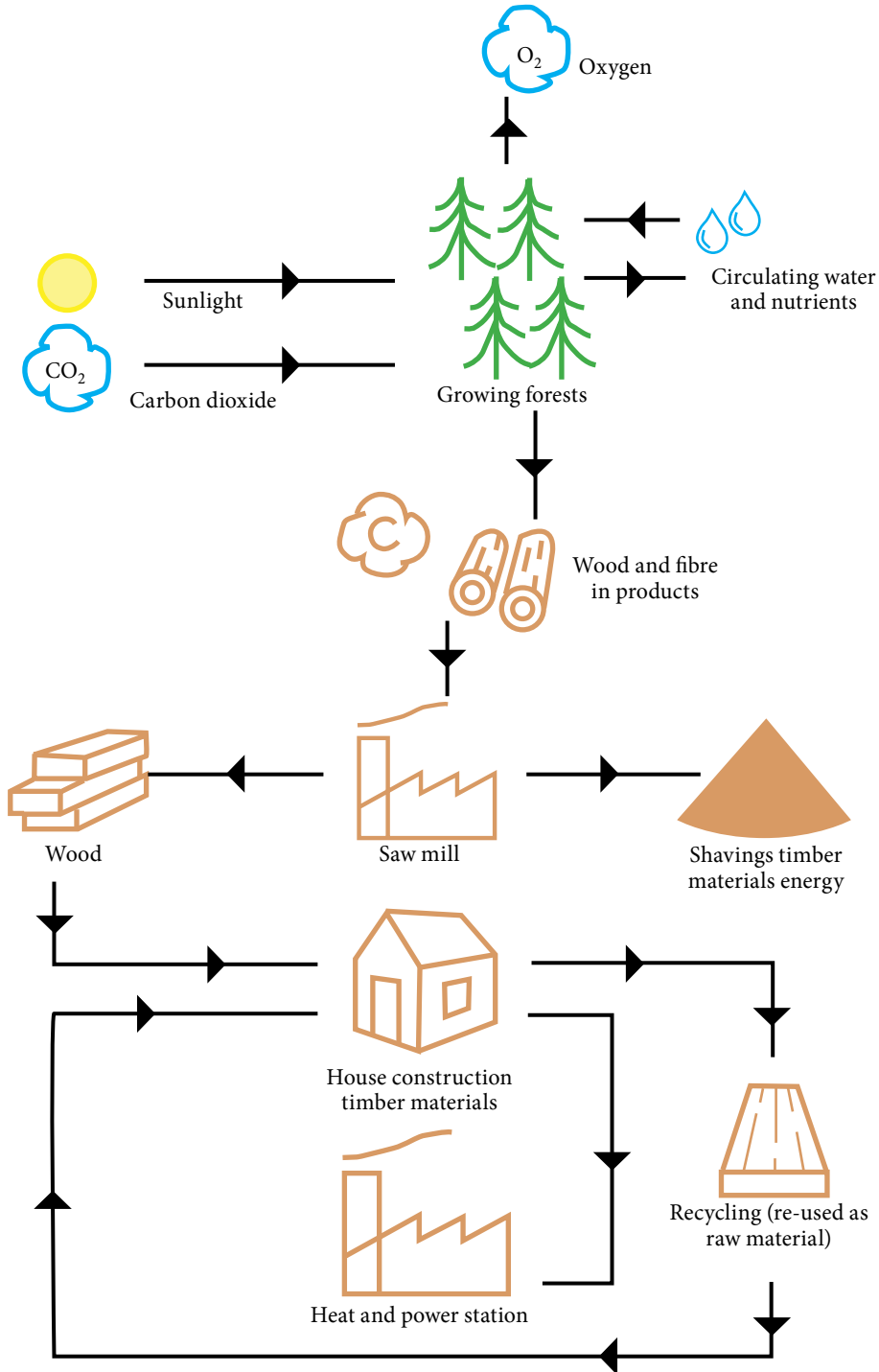


Fig. 1.13. Circular economy in wooden construction (Stora Enso, 2020).



recycling and recycling of materials resources, because the building elements can be separated, which also facilitates handling at the demolition stage.

Is there any wood at all – sustainable – to cover the growing need for wood for the buildings? If the need is to be covered sustainably, it must be assumed, for example, that the harvest of wood in the forests does not exceed the increase. The growth of wood in European forests (without Russia) is 840 million m<sup>3</sup>, while the annual harvest is 583 million m<sup>3</sup> (66 %) (Forest Europe, 2015). There is thus an annual untapped harvest of 257 million m<sup>3</sup> of wood – or 33 % of the increase. In addition, a future increase in the annual m<sup>3</sup> growth can be attributed to the current increase in forest area. Europe's forest area has increased by 17.5 million hectares in the last 25 years (1990–2015), or approx. 700,000 hectares per year. For instance, in Denmark the forest area is increasing and grows by approx. 3000 hectares annually.

The crucial thing is to ensure that the construction tree comes from sustainable production. In Denmark, over 90 % of the forest area is forest and is covered by the Danish Forest law requirements for sustainability and forest cover of the areas. In addition, part of the forestry is further certified according to schemes such as FSC and PEFC. For the purpose of ensuring sustainable wood in public contracts for goods procurement, services and construction work, guidance has been provided for guidelines on the definition and documentation of sustainable wood (Ministry of the Environment, Nature Agency, 2014).

## **Economic aspect**

---

Forests generate wealth and millions of jobs (see Fig. 1.14). The formal timber sector employs more than 13.2 million people. It also produces more than 5,000 types of wood-based products and generates a gross value added of over \$600 billion (≈EUR 493 billion) each year. But the timber sector's economic contribution is much larger – the sector is mainly informal and its value remains largely unreported (The World Bank, n.d.).

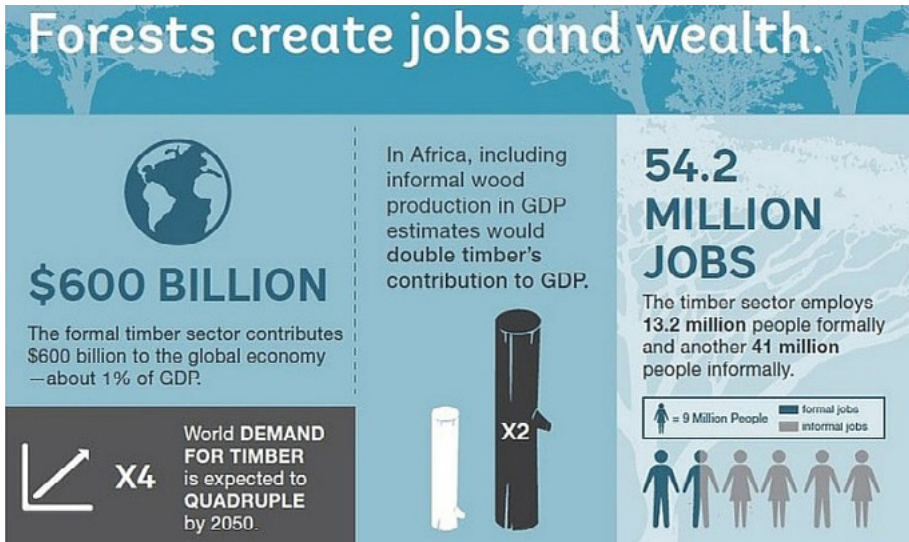


Fig. 1.14. Inputs of timber sector to global economy (The World Bank, n.d.).

Including the informal sector in GDP calculations could double the contribution of the timber sector and quadruple the number of related full-time jobs. In addition, the wood fuel industry creates jobs for tens of millions of households in the form of small-scale wood collection, charcoal production, transportation, and retail. The World Bank Group supports countries to sustainably manage natural forests, expand forest cover and develop sustainable forest industry value chains to create jobs and contribute to sustainable growth (The World Bank, n.d.).

In terms of construction, from the economic perspective, timber products are a cost-effective solution since they are structurally efficient, light weight, easy and quick to install at the construction site (QWEB, 2015). Higher speed of assembly is also linked to reduced labour hours and project cost (Franzini et al., 2018).

American Forest Foundation (n.d.) discusses cost effectiveness of building in wood in more detail:

- Wood can be locally sourced and is usually less expensive than alternative building materials.
- Wood building systems typically cost less to install. Wood is readily available and tends to be delivered quickly.
- Faster construction schedules help to keep costs down. Because wood is often readily available, adaptable and easy to use, construction is faster.

- Contractors can reduce labour and material costs with panelizing, the process of assembling roof sections on the ground and then lifting them into place.
- Using wood can save significantly on construction costs. Woodworks.org offers a cost calculator to help builders estimate cost savings from building with wood, taking into account numerous variables like material costs, speed of construction and availability of labour.

Several studies have at a theoretical level compared the cost of high-rise buildings in timber with the costs of a similar construction in concrete and / or steel. A report from Utah University (Smith et al., 2015), where experiences from 18 listed massive wood buildings in Europe and North America were collected, the average cost of solid wood constructions is estimated to be 4 % lower than for comparable buildings constructed using traditional methods. The same study assessed that the massive tree projects resulted in a 20 % reduction in the overall construction time compared to traditional construction methods.

Another example is from the USA. SD's Clover Creek Elementary (Fig. 1.15), completed in 2012, was built by using a wood framing method. Using wood framing for a school saved about 20 % in materials and installation costs. For a \$10-million ( $\approx$ EUR 8.2-million) project, this translates to a \$2-million



**Fig. 1.15.** BSD's Clover Creek Elementary, USA (WoodWorks, n.d.).

(1.64-million) savings (American Forest Foundation, n.d.).

Since building traditions and principles are difficult to compare directly across national borders, it is also impossible to transfer economic and time comparisons. In England, there is talk of a significant reduction in construction time, but this compares with in situ cast concrete constructions, which, in everything else, will have a considerably longer construction time and drying time than prefabricated element building.

In assessing the economic sustainability of timber construction, it is also necessary to include the potential added value that wooden buildings can contribute. The project of BSD's Clover Creek Elementary revealed that cost-efficient wood framing leads to energy-efficient schools. Energy savings leave more money for education.

On the other hand, speaking about commercial buildings, viewed in a lifecycle perspective, the additional rental income from the new building will be a clear advantage in the economic analysis.

The choice of wood can contribute added value to the project, which could not be achieved by traditional construction methods.

The shorter construction time for wooden buildings also adds value. An example of fast construction time is from Vancouver, Canada. The construction of the Brock Commons student dormitory at the University of British Columbia (UBC) with its 18 floors was finished in 2017 (Fig. 1.16). The wood structure was complete less than 70 days after the prefabricated components arrived on site, approximately four months faster than a typical project of this size. The estimated avoided and sequestered greenhouse gases from the wood used in the building is equivalent to removing 511 cars off the road for a year. The total carbon dioxide equivalent avoided by using wood products over other materials in the building is more than 2,432 metric tons. The building was designed to meet LEED Gold certification (Think Wood, n.d.).

## Social aspect

---

Last but not least, socio-cultural aspects such as public acceptance and appreciation of a building are also important. Is a building easy to access? Does it have an aesthetically pleasing design? How does it affect people's quality of life? ProHolz BW GmbH reports on its website that wood makes

you feel good, lowers the heart rate and has a positive effect on people's health. In addition, wood breathes and regulates the indoor climate and humidity (Bioeconomy BW, n.d.).

“Wood has psychological effects on people and a similar stress-reducing effect to nature”, says Marjut Wallenius, a Docent and Doctor of Psychology of



**Fig. 1.16.** Brock Commons Tallwood House (Acton Ostry Architects Inc., 2018).

the University of Tampere. The use of wood promotes the health and well-being of mind and body (Wood for Good, n.d.).

Based on studies carried out in Norway, Japan, Canada and Austria, wood seems to have positive effects on the emotional state of people. Environments with wooden structures cause a drop in blood pressure and pulse and have a calming effect.

But what factors in wood as a building material affect people? According to M. Wallenius “Wooden surfaces make a room feel warmer and cozier and they also have a calming effect. In these properties, wood beats all other normal surface materials” (Wood for Good, n.d.).

The answer to the question ‘what is a good material for people?’ is sought through human experience and how this positive experience manifests itself physiologically and psychologically. “One answer is the naturalness of wood, which is also found in all other natural materials such as rock, linen and silk. The naturalness and natural origin of wood is also why wood is considered a warm and cozy material in construction” (Wood for Good, n.d.).

According to observations made in research, touching a wooden surface gives people a feeling of safety and being close to nature. In studies, for example touching aluminum at room temperature, cool plastic or stainless steel caused a rise in blood pressure. Touching a wooden surface, however, did not cause such a reaction. In a comparison of different work rooms, stress level, measured as the skin’s capacity to conduct electricity, was lowest in a room with wooden furniture (Wood for Good, n.d.).

Studies have shown that compared to standard classrooms, timber classrooms give pupils a greater ability to concentrate and help to reduce stress and tension (Stora Enso, 2020).

In Canada, the government has made an official recommendation to consider building with wood as structural material in all public projects. This practice has not come to Europe yet, but there are numerous examples how wood is used in sustainable construction of public buildings.



## Case studies

---

**Case study 1.** Vennesla Library and Culture House / Helen & Hard (Fig. 1.17).

The Municipality of Vennesla decided in 2005 to relocate the library to the city centre, linking together an existing community house and learning centre into a cultural centre. A café, open meeting places and a small stage were incorporated into the plan of the new building, making it a combined library and house of culture. With the new building, the municipality sought both to establish a public meeting place and to increase the quality of architecture in the urban area of Vennesla. An architectural design competition was initiated in 2008; it was won by the firm Helen & Hard from Stavanger, and the new building was ready in 2011.

27 prefabricated glue-laminated timber ribs define the spatial expression of the interior, and their offset construction allows the curves to function as spatial interfaces with inset lighting elements to provide a soft glow to the interiors and acoustic absorbents which contain the air conditioning ducts. Typical of Helen & Hard's work, the project also focuses on reducing the energy need through the use of high standard energy saving solutions in all new parts of the project. The library is a low-energy building, defined as class 'A' in the Norwegian energy-use definition system (Archdaily, 2011). The building won several prizes, among them *Statens byggeskikkpris* for 2012 (the Norwegian state prize for good buildings).



**Fig. 1.17.** Vennesla library in Norway. Image: Emile Ashley (New Nordic Timber, 2019).

**Case study 2.** Unterdorf Elementary School, Höchst, Austria (Fig. 1.18).

A fixture in Scandinavian countries, cluster schools are gaining ground in Austria. The pedagogical approach behind these types of schools involves teaching in small groups, flexible spaces and diversified, preferably outdoor, open areas. There are no classrooms along the access corridors; instead, open layouts allow for different forms of teaching and learning. In recent years, schools in the region have been architecturally implementing these requirements in different manners. The architects have delivered a radical example of this approach in the recently completed Unterdorf Elementary School (Dovetail, 2018).

In a plain, elongated, ground-level wooden building, four identical clusters are placed on the east side; the special education classes and the administrative area are located on the west side. A spacious hall connects the special education area with the gymnasium. The clusters comprise two central classrooms, an open group area and a quiet room, as well as washrooms and wardrobes around a central lounge. Each lounge is topped by an elevated, truncated pyramid through which daylight flows (Dovetail, 2018).



**Fig. 1.18.** Unterdorf School in Höchst, Austria. Image: Dietrich Untertrifall (New Nordic Timber, 2019).



The entire school is of pure timber construction. The multi-layer, glued-together solid wood panel surfaces are unclad and the timber framework is visible in every room. Students benefit from the better learning environment and a pleasant, warm atmosphere within the building, which also saves on heating costs. The materials used are based on the fundamental principles of sustainability and ecological efficiency. The renewable, regional building material used dramatically reduced the gray energy factor (Dovetail, 2018).

**Case study 3.** World's first all-timber stadium (Fig. 1.19).

Zaha Hadid Architects has won the planning permission for the world's first wooden football stadium, which will be built in Gloucestershire, England for football club Forest Green Rovers. When complete it aims to be the world's greenest football stadium, constructed entirely from timber and powered by sustainable energy sources (Fig. 1.19).

It was the second attempt to gain planning permission for the 5,000-seat timber stadium for Forest Green Rovers football club. Zaha Hadid Architects (ZHA) changed the stadium design to include an all-weather pitch and included a different landscaping strategy. This was to mitigate worries that the stadium design did not sufficiently make up for the loss of green fields it will be built on.



**Fig. 1.19.** Zaha Hadid Architects stadium, UK (Block, 2019).

An improved match day transport plan was also included, following planning committee concerns about noise and traffic (Block, 2019).

ZHA's stadium design was voted through by six votes for and four against on 18 December 2019.

“This building is iconic; it could be a tourist attraction. It will be built entirely from sustainably sourced wood, including the cantilevering roof and louvred cladding.” A transparent membrane will cover the stadium, allowing the grass to grow under the sunlight and minimizing shadows that could distract players during the game. The importance of using wood is not only that it is a naturally occurring material, it has very low carbon content.

This stadium will have the lowest carbon content of any stadium in the world and will be the greenest football stadium in the world.

Forest Green Rovers has already been named the world's greenest football club by FIFA. The players have adopted a vegan diet to reduce their carbon footprint, and only vegan food is served on match days. The current stadium has an organic grass pitch watered with recycled rainwater and uses solar panels to power its floodlights. The pitch is mowed by an electric 'mow bot' that uses GPS technology to automatically cut the grass, with the grass clippings given to local farmers to put on their soil (Block, 2019).

**Case study 4.** Norway to build the world's tallest timber building (Fig. 1.20).

Norway is set to break records for tall-timber construction with a new structure in a town just north of Oslo. Mjøstårnet will be more than 80 metres tall – 30 metres higher than what is today considered the world's tallest timber building. The building is named after its neighbour and Norway's largest lake Mjøsa and will sit on the edge of the north-eastern tip of the lake in the small town of Brumunddal.

Arthur Buchardt, investor and contracting client, has dubbed the construction “the closest we come to a skyscraper in timber” and believes “Mjøstårnet sets new standards for timber constructions”. Spanning over 18 floors, the building will include apartments, an indoor swimming pool, hotel, offices, restaurant and communal areas with construction scheduled to be completed in December 2018. Moelven, a Mjøsa-local Scandinavian industrial group, will supply the timber constructions from local spruce forests required to construct the tower and the swimming pool area. The assembly and construction of

Mjøstårnet is nothing short of world-class engineering and will be managed without external scaffolding, despite the complexity of working at heights.

The construction company will primarily use cranes supplemented by lifts as needed. Timber structures are becoming increasingly popular, not least for their eco-friendly credentials. The studies show that building with wood instead of concrete can reduce CO<sub>2</sub> emissions by up to 30 percent. Through Mjøstårnet it is demonstrated that it is possible to construct large, complex wooden buildings. The planned construction of the Norwegian Government quarter can become a wooden landmark internationally. This project wants to help convey an important message with this project. To build with wood is to contribute to the world breathing better (McPartland, 2017).



**Fig. 1.20.** Mjøstårnet in Norway (McPartland, 2017).

## 1.4. SUSTAINABLE BUILDING RATING SYSTEMS

**Carl Mills,**

School of Energy, Construction and Environment, Coventry University

**Araz J. Agha,**

School of Energy, Construction and Environment, Coventry University

**Laura Tupenaite,**

Department of Construction Management and Real Estate,  
Vilnius Gediminas Technical University

**Simona Krasauskiene,**

Study and Consulting Center

Currently hundreds of environmental rating systems and sustainability certification schemes exist worldwide, and the demand for more certified buildings continue to rise. This chapter introduces an overview of leading environmental assessment methods which are relevant to the European construction industries, providing readers with a number of case studies based on timber building application and certification. Each of these systems are presented with an insight description into the history, scope and mechanism as well as the value and advantage of certification.

*Why certification is important?* The hotel star rating system was created to measure and classify the quality of the hotels in terms of services, rooms, and facilities. Based on the star rating your expectation as a customer will be different when you book a room. Europe and the U.S. use different hotel star rating systems, however, the concept remains the same, which is, categorizing the quality. The same theory applies to the rating certification systems of buildings by addressing the building's structure and construction process in respect of having a minimum direct and indirect impact on the built environment with regard to planning, design, construction, waste, materials, energy efficiency, maintenance, refurbishment, and demolition. Achieving high environmental rating classification requires a very strong collaboration

among the client, designers and engineers in every project stage (Whole Building Design Guide [WBDG], 2019).

Generally, every prescriptive-based rating system offers a certain percentage of credits that can be achieved with the use of wood or wood products. In most cases, wood is recognized in the following areas (WoodWorks, n.d.):

- Certified wood. Credits are awarded for wood that has been third-party certified as coming from a sustainably managed forest. Different rating systems allow for different certification programs, with some more inclusive than others. While rating systems commonly reward projects that use certified wood, they do not require any demonstration that competitive materials such as concrete, steel, or plastic have come from a sustainable resource.
- Recycled / reused / salvaged materials. Many rating systems give credits for the use of products with recycled content. Wood products that qualify include finger-jointed studs, medium-density fiberboard, and insulation board.
- Local sourcing of materials. A number of systems place special emphasis on the use of local materials as an approach to reducing the environmental impacts of construction projects, rewarding materials sourced from within a certain radius - commonly 500 miles (approx. 804.672 km). However, simply tracking transportation distances ignores such critically important factors as mode of transportation and the type, efficiency, and impacts of manufacturing processes. Helen Goodland, an expert in green building and principal of Brantwood Consulting Partnership, explains that “rather than focusing solely on transportation distances, rating systems should look at life cycle assessment methodology, which quantitatively analyses not just transportation impacts, but the total environmental footprint of all materials and energy flows, either as input or output, over the life of a product from raw material to end-of-life disposal or reuse”.
- Materials efficiency. Many rating systems, such as LEED, Green Globes, Built Green Canada, BREEAM, and Earthcraft reward efficient use of building materials.
- Waste minimization. Credit is often awarded for avoiding or diverting construction waste – e.g. through jobsite protocols that include pre-cut packages or off-site production of building modules.
- Indoor air quality. Most rating systems have strict limits on the use of products that contain volatile organic compounds (VOCs). Many wood products are available that verifiably meet or exceed these guidelines.

### 1.4.1. Building Research Establishment's Environmental Assessment (BREEAM)

---

The drive toward sustainable buildings grew with the launch of the Building Research Establishment's Environmental Assessment Method (BREEAM) in 1990, the first green building rating system in the world. Worldwide there are more than 571,591 BREEAM certified buildings and 2,283,771 buildings registered for assessment since it was first launched in 1990 (BREEAM, 2020). BREEAM encourages and motivates designers and builders to stand out through being innovative and use resources efficiently. Attention to the sustainability value and greener aspect of the buildings made BREEAM rated buildings to be more attractive to the marketplace, property developers and investors and also produce a sustainable environment that increases the well-being of the occupants.

The BREEAM assessment process evaluates the procurement, design, construction and operation of a development against targets that are based on performance benchmarks. Assessments are carried out by independent, licensed assessors, and developments rated and certified on a scale of Pass, Good, Very Good, Excellent and Outstanding. BREEAM measures sustainable value in a series of categories, ranging from energy to ecology. Each of these categories addresses the most influential factors, including low impact design and carbon emissions reduction; design durability and resilience; adaption to climate change; and ecological value and biodiversity protection (BRE, 2020).

BREEAM is used by owners, users, building managers and designers to demonstrate their environmental commitment, reduce the running costs and to reduce the impact that their buildings have on the environment (BREEAM, 2020).

Drivers:

- building regulations;
- towards zero carbon from 2019 for all buildings;
- UN framework Convention on Climate Change & Kyoto;
- legally binding commitments for the reduction of greenhouse gases;
- EU Renewable Energy Directive 15;
- 15 % of energy consumption should be from renewable source by 2020;
- Climate Change Act 2008;

- legal obligation to Government to reduce carbon dioxide emissions by at least 80 % by 2050;
- planning system;
- national ambitions will be tested through the planning system, both at regional and local level (BRE, 2020).

The Building Research Establishment has standard models for several types of development: offices, schools and education, light industrial, warehousing (non-retail), residential retail, prisons, courts and health (BRE, 2020).

While BREEAM focuses on achieving certain economic and social benefits, it also aims to mitigate the impact of construction process and buildings on the built environment as well as provide a rating system enabling buildings to be recognised based on their sustainability approach which encourages global demand for developing more sustainable buildings.

BREEAM aims to achieve the following highlighted fundamentals:

- To distinguish buildings of reduced environmental impact in the marketplace.
- To ensure that the best environmental practice is incorporated in building design, operation, management and maintenance.
- To set criteria and standards surpassing those required by regulations.
- To inform the design process.
- To raise the awareness of owners, occupants, designers and operators of the benefits of buildings with a reduced impact on the environment and the benefits of building to best environmental practice standards.
- To allow organisations to demonstrate progress towards corporate environmental objectives:
  - ensure quality through an accessible, holistic and balanced measure of sustainability impacts;
  - use quantified measures for determining sustainability;
  - adopt a flexible approach, avoiding prescriptive specification and design solutions;
  - use best available science and practice as the basis for quantifying and calibrating a cost-effective performance standard for defining sustainability;
  - seek economic, social and environmental gains jointly and simultaneously;
  - provide a common framework of assessment that is tailored to meet



- the ‘local’ context, including regulation, climate and sector;
- integrate construction professionals in the development and operational processes to ensure wide understanding and accessibility;
  - adopt third party certification to ensure independence, credibility and consistency of the label;
  - adopt existing industry tools, practices and other standards wherever possible to support developments in policy and technology, build on existing skills and understanding and minimize costs;
  - use stakeholder consultation to inform ongoing development in accordance with the underlying principles and the pace of change in performance standards (accounting for policy, regulation and market capability) (BRE Global, 2016).

The benefit of sustainable development could be considered as a key attraction by most of the industry professionals. Many researches have been conducted recently to outline the true value of BREEAM and how it benefits different stakeholders, including developers, landlord and end users. This section summarises the value of BREEAM certified buildings:

- Reduced running costs through greater energy and water efficiency, and reduced maintenance.
- Healthy, comfortable and flexible internal environments.
- Access to local amenities.
- Less dependence on the car.
- Allowing developers to be one step ahead of regulation.
- Demonstrating compliance with environmental requirements from occupiers, planners, development agencies and developers.
- Environmental improvement - in support of a wider corporate strategy or as a standalone contribution.
- Occupant benefits: a better place for people to work and live.
- Marketing: a selling point to potential tenants or customers.
- Financial: achieving higher rental incomes and increased building efficiency.
- Best practice: providing a thorough checklist or tool for comparing buildings.
- Client request: responding to the requirements of users (BRE Global, 2016).

## **BREEAM categories**

---

Awarding credit scoring system is based on the environmental impact of each category. The 10 categories are not carrying equal weight, and each credit



within the category has a different weight, e.g. two credits granted do not equal 2 %. The key principles for each BREEAM category have been summarized as follows (Fig. 1.21):

- Management – management policies, building commissioning and procedural issues.
- Health and Well-being – indoor and external issues affecting health and well-being of building occupants, e.g. thermal conditions, daylighting, glare, etc.
- Energy – operational energy (and CO<sub>2</sub> emissions) of the completed development. The energy category is heavily dependent on the expected carbon emissions (including Low Carbon and Renewable Technologies); however, it also includes credit points relating to metering and sub-metering.
- Transport – a series of transport and site access related credit points, e.g. cyclist facilities, public transport links, deliveries, etc.



Fig. 1.21. BREEAM categories (BRE, 2020).

- Water – credit points relating to efficient water use of base building and tenant services.
- Materials – environmental implications of building materials including responsible sourcing and lifecycle impacts.
- Waste – rewards for recycling and management of waste products both during construction and once in operation.
- Land Use and Ecology – credit points to encourage the use of brownfield sites, rehabilitation of contaminated land as well as conservation and enhancement of the site ecology.
- Pollution – reduction and / or elimination of air, water and light pollution.
- Innovation – additional credits available by significantly exceeding particular BREEAM requirements, using BREEAM accredited professionals, or being genuinely innovative in approach (BRE Global, 2016).

BREEAM provides Innovation scores based on any performance level which is beyond the standard performance acknowledged by the BREEAM assessment criteria. Innovation scores could be achieved either through exceeding the standard performance criteria specified by BREEAM assessment guide, or by providing a certain new technology or an innovative idea in terms of the design, construction method or construction process. To gain the innovation credit, the developers should assign a registered BREEAM Assessor to submit a standalone application to BRE Global. For each innovation credit an extra 1 % could be achieved up to maximum of 10 credits.

Category	Weighting	BREEAM Score	
Management	12 %	Pass	30 %
Health & Well-Being	15 %	Good	45 %
Energy	19 %	Very good	55 %
Transport	8 %	Excellent	70 %
Water	6 %	Outstanding	85 %
Materials	12.5 %		
Waste	7.5 %		
Land Use & Ecology	10 %		
Pollution	10 %		
Innovation	10 %		

Fig. 1.22. BREEAM certification (BRE, 2020).

## BREEAM benchmarks

When it comes to awarding the final certificate, BREEAM Rating scales from Pass to Outstanding. To achieve a specific rating, a sequence of obligatory minimum standards must be obtained. Once the required minimum standards are achieved, the development can aim for additional credit scores to obtain the required and expected credit rating. Figure 1.22 is summarizing the weighting percentage and the required credits to gain a certain level of BREEAM certification.

BREEAM continues to provide the national and international market with a robust framework towards a more sustainable construction industry, consequently thousands of stakeholders and developers delivered better and greener buildings which have minimum impact on the built environment (Fig. 1.23).

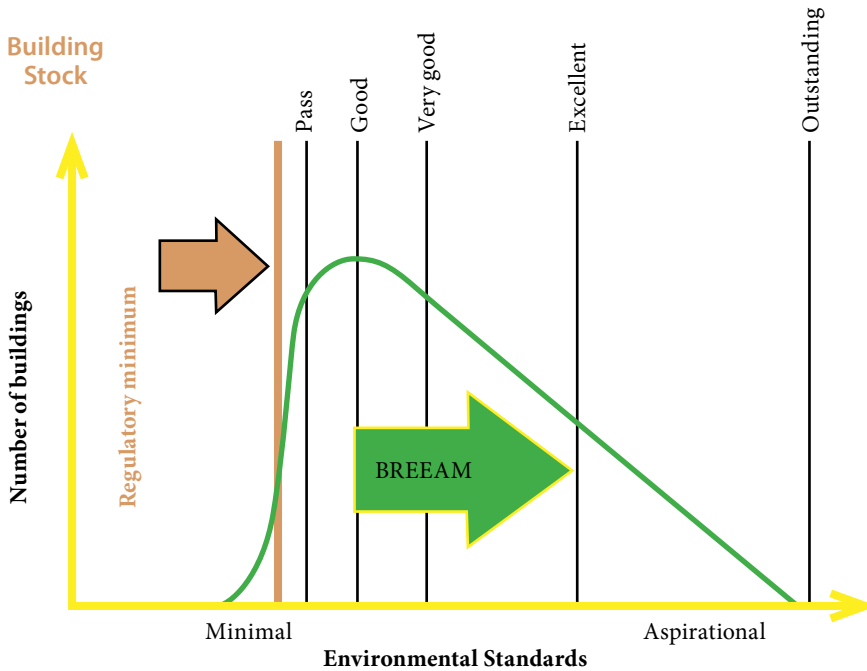


Fig. 1.23. BREEAM and environmental standards (BRE Global, 2016).

## **BREEAM effectiveness**

---

Input is expected to be needed from a wide range of people (the architect and building services designers have the largest share, the project manager, structural engineer and contractors) all have a part to play.

The BREEAM assessor should also be appointed early.

Clients can use BREEAM to specify the environmental sustainability performance of their buildings in a way that is quick, comprehensive and visible in the marketplace.

Agents are allowed to use BREEAM to promote the environmental credentials and benefits of a building to potential clients.

Design teams can use BREEAM as a tool to improve the performance of the buildings and their own experience and knowledge of environmental aspects of sustainability (Parker, 2012).

## **The BREEAM schemes**

---

BREEAM develops and manages a number of BREEAM schemes nationally and internationally. Each scheme has been created to assess the various stages of building's impact which include:

- BREEAM New Construction: for new, non-residential buildings in the UK.
- BREEAM International New Construction: for new residential and non-residential buildings in countries around the world. This scheme makes use of assessment criteria that take account of the circumstances, priorities, codes and standards of the country or region in which the development is located.
- BREEAM In-Use: a scheme to help building managers reduce the running costs and improve the environmental performance of existing buildings.
- BREEAM Refurbishment: provides a design and assessment method for sustainable housing refurbishment projects, helping to cost effectively improve the sustainability and environmental performance of existing dwellings in a robust way.
- BREEAM Communities: focusses on the master planning of whole communities (BRE 2020).

Green Book Live platform has been created by the BRE Global, which is an independent body, providing certification for sustainable services and products globally. Conducting many researches to improve the built environment it aims to “Protect People, Property and the Planet”. This free online platform provides developers and BREEAM assessors to identify green products and sustainable services which reduce developments negative impact on the environment.

## The BREEAM assessment process

BREEAM assessors have a vital role during the process of BREEAM certification, and they are leaders who drive the construction industry towards building a more sustainable world. Most of the planning authorities and city councils across the United Kingdom made it compulsory for the commercial

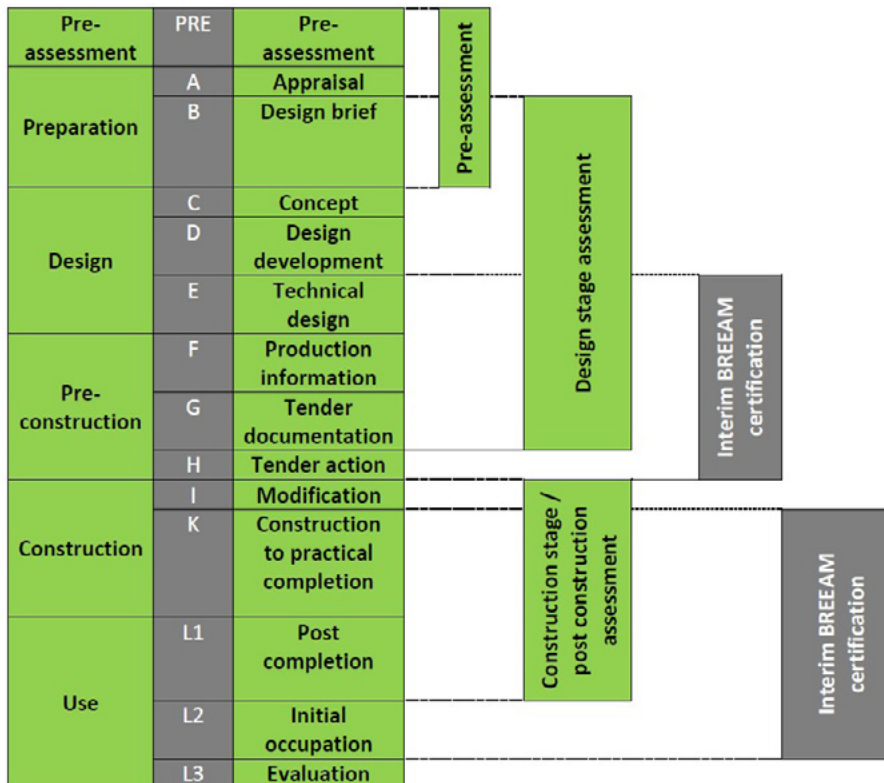


Fig. 1.24. BREEAM assessment process and certification timeline (BRE, 2020).

buildings, residential buildings and also any other publicly funded domestic refurbishment or building to be assessed under the BREEAM scheme. This request is coming either as a conditional grant of planning permission or as a part of the contract to obtain funding for the social housing. BREEAM certification process is undertaken in five stages (Fig. 1.24) (BRE, 2020):

**1. Registration:** It is important to make sure that the project is formally registered with the BRE and the registration checklist has been completed.

**2. Pre-assessment:** This process is undertaken at a very early stage, even before the design has been confirmed, to secure the funding and planning permission. At this stage the design team work closely with the assessor to set up a pragmatic baseline for the project which can provide solutions and options to achieve the best performance. The assessor explains the BREEAM criteria and establishes a score target based on the information available. After the first meeting with the assessor the design team agrees a period of time to review and add any more information required for the process and confirm their commitment to the agreed BREEAM rating. At this stage the assessor prepares and issues the pre-assessment report to BRE.

**3. Initial Guidance / Design & Procurement Assessment:** In this stage the assessor will complete a guidance report explaining the required performance and documentation to achieve each credit. Based on the agreed target, available information and all the approved documentation by the design team, the assessor will complete and submit the Design & Procurement Assessment report to BRE for quality check and also to receive the Design & Procurement Assessment.

**4. Post Construction Review (PCR):** The process has no formal construction stage; however, the assessor continues to provide support and advice during the construction phase and collects and records all the evidence and documentation required for the Post Construction Review report. The PCR is undertaken after the project completion. The key purpose of this stage is to make sure that the completed development is meeting the agreed criteria during the design and procurement stage. The assessor will visit the site and take photos of the implemented technology, systems, construction methods, materials and features of the building, creating a photographic file as an additional evidence to support the required documentation for the 'as built' report.

**5. Final Certification:** Once all the evidence, documentation and required

information has been submitted and the agreed target has been achieved, the BRE will issue the final certificate.

The assessors' role is vital to the project, they are the active link between the design team and the certification body. Qualified BREEAM assessor understands the scheme, the process, rating criteria and can provide the interpretation for each technical issue as well as work with the designing team to help and provide advice on how to collect scores and achieve the end target. The assessor has the duty of communicating between the BRE and the client. For any extra information, evidence or request, the assessor should coordinate with the project team to prepare the requirements which should be submitted with the final report. The engagement of the assessor in the very early stage has a positive impact on the whole project and helps achieving the agreed target without affecting the design and the proposed budget, also securing the seamless integration of the methodology of any development. If the assessor is appointed at a late stage, the required changes could be compromised, the performance and extra costs could be needed to cover the requested changes (BRE, 2020).

## Case studies

---

**Case study 1.** GlaxoSmithKline: A BREEAM Outstanding carbon neutral laboratory (Fig. 1.25).

The building is a hub that will catalyse new collaboration with industry. It is the latest landmark development to be undertaken by the University of Nottingham, and it is unique in the UK not only in its design but also in its focus on world leading research activity in sustainable chemistry.

### Project Overview:

Scheme & Version: New Construction 2011: Higher Education

Stage: Final

Location: Nottingham, UK

Score & Rating: 94.1 % Outstanding

Size: 4,199 m<sup>2</sup> (GIFA), 2,319 m<sup>2</sup> (NIFA)

Green Strategy

The building achieved full credits in the Water and Materials Sections of BREEAM and scored at least 90 % in the Management, Energy, Land Use &

Ecology, and Innovation sections.

**Management.** A focus on sustainability integration to ensure delivery of a functional and sustainable asset was considered during every stage of the project. Early-stage sustainability targets were set in cooperation with the University during the Strategic Definition Stage of the project. The BREEAM performance targets were agreed during Conceptual Design, and a target rating of Outstanding was established. A BREEAM AP has been engaged throughout the project to provide advice on maximizing the positive environmental impacts of the building.

**Health and well-being.** Natural ventilation strategies are integrated into the design in conjunction with mechanical ventilation strategies. In particular the carbon neutral laboratory is naturally ventilated – which is unusual and unique for a laboratory. Fresh air intake and exhaust air discharge are supplied and controlled via the roof mounted wind catchers, which are prominent visual features for the project.

**Energy.** The project features innovative energy saving strategies designed to meet the carbon neutral goal. Energy required to run the laboratory is met by renewable and low carbon sources such as the PV array covering 45 % of the roof area and sustainable biofuel CHP. The project achieved 15 credits and 5 innovation credits under BREEAM Ene 01 and used this as an Alternative Compliance Path to receive full point value for LEED Energy Performance, On-Site Renewable Energy and Green Power credits. The building also includes LED lighting with a building average of 5.4 Watt/m<sup>2</sup>.



Fig. 1.25. GlaxoSmithKline, UK (BREEAM, 2020).



The building has sub-meters that are installed on major energy consuming systems, including space heating, domestic hot water, cooling, fans, lighting, small power, IT room, lifts, and laboratories.

**Transportation.** The project's campus location encourages the use of public transportation networks. The building is served by multiple bus services connecting it to the wider Nottingham area and major transport hubs. The site is situated near basic amenities and services, including cafes, libraries, a sports centre and a student union, which reduces the need for building users to make multiple journeys. Cycling facilities are provided for building occupants. New cycle spaces were added to the design, shower & changing facilities, and sheltered cycle storage, which will be accessible from the street to the front of the building.

**Water.** The project achieved full credits in the water category. The BREEAM calculator tool calculated water consumption to be just 5.47 m<sup>3</sup> per person per year. This represents a 63.99 % improvement in water efficiency compared to the baseline for the building. This was achieved through the use of water efficient fittings alone. The project's green roof consists of drought tolerant, native species that do not require an irrigation system to be installed. All major water uses are separately metered within the building allowing high use activities to be identified by the building management. A leak detection system was installed to monitor water use and alert building managers to potential issues during operation, allowing them to be resolved.

**Materials & waste.** The building is unique in that timber is featured prominently in design. Timber was sustainably sourced through PEFC and FSC certification schemes and was used for the frame, walls and floors. The building has been recognised by the Structural Timber Awards 2016 for the innovative use of timber. The team received points for resource efficiency and additional points for the total construction by meeting the BREEAM efficiency benchmark of waste generated per 100 m<sup>2</sup>; yielding 3.8 tonnes/100 m<sup>2</sup>.

**Land use and ecology.** The project was developed on land that was previously occupied by the Raleigh factory. Some contaminated land was identified by a specialist who recommended a remediation strategy, including a clean capping layer for asbestos contamination, restriction of infiltration through contaminated source areas, and ground gas protection measures. This land would have otherwise remained contaminated and undeveloped. Bird boxes and a biologically diverse green roof on the project provide a welcoming

environment for local species, and also a 5-year landscape management plan was implemented and includes management of protected habitats.

**Pollution.** The project team specified equipment designed to decrease greenhouse gas emissions arising from the leakage of refrigerants from building systems. A flood risk consultant was appointed to analyse surface water run-off from the site and minimize water course pollution. Sustainable Drainage Systems (SuDS) were integrated into the design, e.g. the green roof, a dry swale, trapped gully, filter drains minimize surface water runoff. Detailed photometric plans and calculations were completed to demonstrate that the external lighting installations met ILE Guidance for reducing light pollution.

**Innovation.** The creation of a carbon assessment calculator which focused on life cycle embodied carbon emissions of products on the project. The buildings' net zero goals, low energy laboratory systems, and natural ventilation strategies are particularly innovative for a laboratory use type (BREEAM 2020).

**Case study 2.** Timber Building - BREEAM Outstanding Adapt Enterprise Centre (Fig. 1.26).

The Enterprise Centre at the University of East Anglia opened in autumn 2015. The 3,400 square metre building is one of the largest timber frame structures in the UK and has achieved BREEAM Outstanding. The building aimed to demonstrate that natural products can provide attractive alternatives



**Fig. 1.26.** The Enterprise Centre at the University of East Anglia, UK (BRE, 2015).

to conventional technologies. Some of the key findings from the research carried out by the BRE Sustainable Products team paved the way for this groundbreaking building are as follows:

- Despite the presence of Red Band Needle Blight (RBNB), this project has shown that the disease does not have a negative effect on the timber properties.
- If innovative twin laminates form a structural frame and flooring, as detailed in this report, are selected, then the 36,000 houses could store an additional 194,400 tCO<sub>2</sub>. This would also unlock a key substitution effect for replacing the blocks in the structure. A house with 60 m<sup>3</sup> blocks in its walls has a net emission of 12 tCO<sub>2</sub> per house associated with the embodied energy in the blocks. This equates to a saving of 432,000 tCO<sub>2</sub> for 36,000 houses.
- Timber technology can add to a limited managed resource in the region. Innovative engineering of wood can utilize more of the standing tree in the construction product; create more construction products per hectare of woodland and store more carbon in our buildings. One of the possible products studied was an innovative inside out beam (Fig. 1.27). This



**Fig. 1.27.** Structures and interior (BRE, 2015).

beam uses 85 % of the round wood in the final product. A square beam of equivalent performance uses no more than 50 % of the round wood in the product. This is not in conflict with existing supply chains.

- The East of England region can be creative with woodland resource and productivity but it needs a radical change in strategy. For example, if an inside out beam requires a tree of half the maturity of the equivalent square cut beam; in the same time period a hectare yields two times as many beams and possibly up to four times as many beams if planting density can be increased.
- Corsican pine from Thetford forest is of sufficient quality to be used in a range of structural construction product end uses. It meets as a minimum machine strength grading 'C16' class (BRE, 2015).

## 1.4.2. Leadership in Energy and Environmental Design (LEED®)

---

LEED® (*Leadership in Energy and Environmental Design*) was developed and piloted in the USA in 1998 as a consensus-based building rating system based on the use of existing building technology. The LEED® has been developed through the U.S. Green Building Council (USGBC) member committees. It is the most widely used green building rating system in the world with 1.85 million square feet of construction space certifying every day. More than 79,000 projects are participating in LEED® across 160 countries and territories, comprising over 15 billion square feet (LEED, 2019).

LEED® certification provides independent verification of a building or neighbourhood's green features, allowing for the design, construction, operations and maintenance of resource-efficient, high-performing, healthy, cost-effective buildings. LEED is the triple bottom line in action, benefiting people, planet and profit (LEED, 2019).

LEED® works for all buildings at all phases of development, from new construction to existing buildings, as well as all building sectors, from homes to hospitals to corporate headquarters. LEED for Building Design and Construction (LEED® BD+C) provides a framework for building a holistic green building, giving the chance to create a healthy, resource-efficient, cost-effective building. LEED for Building Operations and Maintenance (LEED® O+M) is designed for existing buildings and leads to increasing of operational efficiency. LEED® for Interior Design and Construction (LEED® ID+C) enables project teams who may not have control over whole building operations to develop indoor spaces that are better for the planet and for people. LEED® for homes provides certification for homes that are built to be healthy, providing clean indoor air and incorporating safe building materials to ensure a comfortable home, using less energy and water means. LEED® for Neighbourhood Development (LEED ND) was engineered to inspire and help create better, more sustainable, well-connected neighbourhoods. It looks beyond the scale of buildings to consider entire communities (LEED, 2019).



Fig. 1.28. LEED credit categories (DMCC, 2020).

## LEED credit categories

---

LEED® projects earn points across nine basic areas that address key aspects of green buildings (see Table 1.5, Fig. 1.28). Based on the number of points achieved, a project earns one of four LEED rating levels: Certified, Silver, Gold or Platinum (Fig. 1.29).

LEED-certified buildings have been proven to benefit in a number of ways. These include (DMCC, 2020):

- higher operating efficiency and lower operating costs;
- promoting occupants' well-being and comfort and thus increasing their productivity;
- increased waste diversion from landfills;
- energy and water conservation;
- reduction in greenhouse gases;
- an increased real estate value; and
- contribution to a sustainable planet.

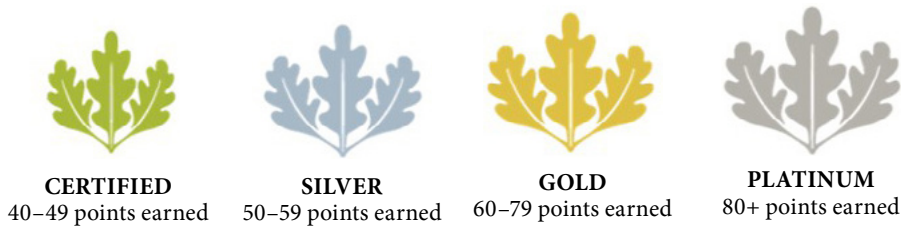


Fig. 1.29. LEED rating levels (DMCC, 2020).

Table 1.5  
Description of LEED® Categories (Banyan Water, 2019)

Category	Description
Integrative process	Beginning in pre-design and continuing throughout the design phases, the category identifies and uses opportunities to achieve synergies across disciplines and building systems.
Location and transportation	The category rewards thoughtful decisions about building location with credits that encourage compact development, alternative transportation, and connection with amenities such as restaurants and parks.
Sustainable sites	The category focuses on the environment surrounding the building and awards credits for projects that emphasize the vital relationships among buildings, ecosystems, and ecosystem services. It focuses on restoring project site elements integrating the site with local and regional ecosystems and preserving the biodiversity that natural systems rely on.
Water efficiency	The category addresses water holistically, looking at indoor use, outdoor use, specialized uses, and metering. The section is based on an 'efficiency first' approach to water conservation.
Energy and atmosphere	The category approaches energy from a holistic perspective, addressing energy use reduction, energy-efficient design strategies, and renewable energy sources.
Materials and resources	The category focuses on minimizing the embodied energy and other impacts associated with the extraction, processing, transport, maintenance, and disposal of building materials. The requirements are designed to support a life-cycle approach that improves performance and promotes resource efficiency.
Indoor environmental quality	The category rewards decisions made by project teams about indoor air quality and thermal, visual, and acoustic comfort. Green buildings with good indoor environmental quality protect the health and comfort of building occupants.
Innovation	The purpose of this LEED category is to recognize projects for innovative building features and sustainable building practices and strategies.
Regional priority	Because some environmental issues are particular to a locale, volunteers from USGBC chapters and the LEED International Roundtable have identified distinct environmental priorities within their areas and the credits that address those issues. These regional priority credits encourage project teams to focus on their local environmental priorities.

## LEED credit for building in wood

On April 5, 2016, the U.S. USGBC released a pilot Alternative Compliance Path (ACP) for wood and paper products in its LEED® 2009 and LEED v4 rating systems which enables all certified products to be eligible for LEED®



credit. Builders and architects can now use wood and paper products certified to the Sustainable Forestry Initiative (SFI), American Tree Farm System (ATFS), Canadian Standards Association (CSA) and Programme for the Endorsement of Forest Certification (PEFC) standards to achieve a point in the 'certified wood' ACP under LEED® 2009 and achieve a point in the 'sourcing of raw materials' ACP under LEED v4 (Sustainable Forestry Initiative, 2016). This is in addition to the existing credit for wood products certified by FSC as having been obtained from responsibly managed sources.

In order to count towards a LEED® point, the user must first know the following (Sustainable Forestry Initiative, 2016):

- 100 % of the forest products are from legal (noncontroversial) sources;
- 70 % are from responsible sources;
- the remainder must be certified sources as evidenced by a chain of custody certification (CoC).

Although some LEED® credits can be obtained based on the percentage of certified wood used on a project, the new program greatly increases the sources of wood for which credits can be received. In addition to providing certainty to contractors that the wood they use has been obtained from legal sources, the program aims to reduce unregulated and environmentally harmful logging, which is a problem in those countries that lack the rigorous environmental enforcement mechanisms such as exist in the United States. The program also incentivizes the use of wood as a building material that is both sustainable and can sequester carbon for decades (C. Smith & H. Smith, 2016).

USGBC's move comes as new technology has resulted in the development of structural wood building products, such as cross-laminated timber that performs at least as well as less sustainable materials. Cross-laminated timber consists of three, five or seven layers of wood beams laid at right angles to one another and bound together with a specially designed adhesive. Use of this product in building construction carries several advantages. The resulting timbers can be cut to desired dimensions, yielding structural components that are lighter than concrete and steel, yet just as strong and durable. Surprisingly, the adhesive used in producing cross-laminated timbers creates wood products that are highly fire resistant. Another advantage of building with light, cut-to-order structural wood is that the job can be completed more quickly, with less noise, waste, and labour costs than structures utilizing more traditional building materials. And, unlike cross-laminated timbers, most of



the traditional building materials have a larger carbon footprint and do not carry comparable ‘green’ certification (C. Smith & H. Smith, 2016).

USGBC’s announcement of greater opportunities for LEED® credits through the use of wood in building construction is the latest evidence of the increased viability of wood as a structural component in major building projects. This announcement, coupled with the already growing interest in and government support for the use of structural wood, such as cross-laminated timbers, is almost certain to continue as part of the search for environmentally friendly and structurally sound building materials (C. Smith & H. Smith, 2016).

## Case studies

---

### Case study 1. John W. Olver Design Building (Fig. 1.30).

Located in Amherst, the University of Massachusetts (USA) has established a new design pavilion. The University decided to use wood as the main structural material in order to have a sustainable structure respectful of the environment. The John W. Olver Design Building, a showcase for best practices in sustainability and state-of-the-art wood construction technology, has been awarded LEED Gold certification (University of Massachusetts, 2018).



**Fig. 1.30.** John W. Olver Design Building, USA (Nordic Structures, 2017).

Called the most technologically advanced cross-laminated timber (CLT) building in the country when it opened in 2017, the Design Building houses three academic units: the Department of Architecture, the Building and Construction Technology Program (BCT) and the Department of Landscape Architecture and Regional Planning. Built of CLT timber and glue-laminated columns, the 87,000-square-foot facility saves the equivalent of more than 2,300 metric tons of carbon when compared to a traditional energy-intensive steel and concrete building (University of Massachusetts, 2018).

The building's multi-disciplinary layout, organized around an interior courtyard of exposed timber and an exterior landscaped courtyard and outdoor classroom, fosters collaboration across the disciplines. It intentionally features exposed structural elements and service systems for teaching, while its Trimble Technology Lab provides advanced tools for design research and development. Key building features for sustainability and LEED certification are as follows (University of Massachusetts, 2018):

- Central to campus, the building is well situated on a walkable site with access to public transportation and promoting use of alternative transportation.
- The previously developed site and landscape was restored with more than 20 % native vegetation and provides open space equal to the building footprint.
- The intensive / extensive vegetated green roof combined with white TPO membrane roofing and light-coloured hardscape (77 % site area) mitigates heat island effects.
- Water efficient fixtures achieve a potable water reduction of 35 % below EPAct 2003 standards.
- Efficient drip irrigation system reduced potable water consumption by 66 % compared to a typical irrigation system.
- Efficient HVAC systems, low-energy lighting design and controls, and a high-performance insulating envelope with electrochromic glass results in a predicted annual energy cost savings of 42.85 %.
- The comprehensive commissioning efforts provided by the design team and owner, combined with ongoing measurement and verification efforts will ensure that the building is operating efficiently and in accordance with all design objectives.
- 88 % of construction waste materials were diverted from landfill.
- 10.7 % of the total building materials (by cost) was manufactured using recycled materials and 13.8 % were regionally sourced. Unfortunately,

the raw materials for the CLT were sourced just beyond the 500-mile radius.

- A whopping 97.3 % of the new wood was FSC-Certified, including 100 % of the CLT.
- In addition to designing for thermal comfort, indoor air quality is improved with CO<sub>2</sub> sensors and associated HVAC controls in all densely occupied spaces.
- 90.5 % of all regularly occupied spaces have access to exterior views.

The Wall Street Journal named the Design Building one of the best new buildings of 2017.

### **Case study 2.** UniCredit Pavilion in Milan (Fig. 1.31).

The UniCredit Pavilion, created by Italian architect Michele de Lucchi, is a modular structure which aims to promote social functions and experimental activities, hosting cultural events, conferences, exhibitions and concerts. The structure, which can accommodate up to 700 people, is build adjacent to the UniCredit's headquarters in the Porta Nuova district in Milan. UniCredit CEO Federico Ghizzoni stated that they wanted a building to reflect the European identity of the brand, but still be representative for Italian architecture (arch20, n.d.).



**Fig. 1.31.** The UniCredit Pavilion in Milan, Italy (Grozdanic, 2017).

It speaks to all categories of users, since it hosts also a nursery for up to 50 children. The building will blend into the urban surroundings through the elevated ground floor, lifted more than one metre above ground, and designed with laminated timber and a glass-ribbed structure, but also with the overall organic shape and transparent surfaces. Two 12-metre-long panels, designed as wings, can be opened or closed, displaying two huge screens towards the park and Piazza Gae Aulenti (arch20, n.d.).

The wooden UniCredit building is powered by the sun. The pavilion has no foundations – it was constructed on a reinforced concrete podium above a parking facility. Inspired by the shape of a seed, the design of the building combines lamellar larch beams with glass. The open structure accentuates accessibility, strengthened by two large wings equipped with monitors for events open to the general public. Thanks to its strong focus on environmental sustainability, the LEED Gold-certified project has won the first prize at this year's WT SmartCity Award competition (Grozdanic, 2017).

### 1.4.3. Passive House (Passivehaus)

---

Passive House is a voluntary and international leading design standard for low energy buildings which reduces the building's ecological footprint and also provides a high level of occupant comfort while using minimum energy for heating and cooling. These buildings are built with careful attention to detail and robust design based on a set of serious principles developed by the Passivhaus Institute in Germany. Throughout the construction process a set of rigid criteria and quality assurance should be followed to obtain the PH certificate (Passivhaus Institute [PHI], 2015). Passive House is not a brand name but a true construction concept that can be applied by anyone, anywhere (Bootland, 2011).

#### Passive House design principles

---

Passive House buildings require a set of design principles used to obtain a quantifiable and rigorous standard of energy efficiency within a specific quantifiable comfort standard (PHI, 2015):

- high levels of insulation (Fabric U-value <0.15 W/m<sup>2</sup>K;

Windows  $<0.8 \text{ W/m}^2\text{K}$ );

- minimal thermal bridging;
- continuous air barrier to achieve  $<0.6 \text{ ach @ } 50 \text{ Pa}$ ;
- provide controlled ventilation and heat recovery during heating season with MVHR; can use natural ventilation in summer;
- maximize use of solar and internal heat gains & protect against overheating and triple glazing windows (U-values below  $0.8 \text{ W/(m}^2\text{K)}$ ) (Fig. 1.32).

Design certification criteria:

- Space heat demand of  $<15 \text{ kWh/m}^2\text{/yr}$  – how much energy is needed to heat the building.
- Pressure test result  $<0.6 \text{ ach @ } 50 \text{ Pa}$  – how much air leaks through the fabric of the building.
- Primary energy  $<120 \text{ kWh/m}^2\text{/yr}$  – how much energy is needed to power all of the activities within the building (heating, hot water, lighting, cooking, appliances, active cooling).
- Frequency of overheating in summer  $<10\%$  – how many times the temperature within the building exceeds  $25 \text{ }^\circ\text{C}$  (PHI, 2015).

There are many benefits of Passive House (PHI, 2015), these are discussed further.

**Comfort.** The Passive House Standard offers a new level of quality pairing a maximum level of comfort both during cold and warm months with reasonable construction costs. Passive House buildings are praised for the high level of comfort they offer. Internal surface temperatures vary little from indoor air temperatures, even in the face of extreme outdoor temperatures. Special windows and a building envelope consisting of a highly insulated roof and floor slab as well as highly insulated exterior walls keep the desired warmth in the house – or undesirable heat out.

**Quality.** Passive House buildings are praised for their efficiency due to their high level of insulation and their airtight design. Another important principle is ‘thermal bridge free design’: the insulation is applied without any ‘weak spots’

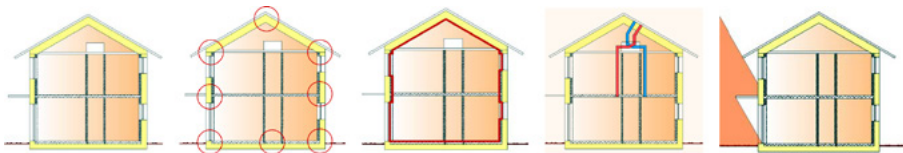


Fig. 1.32. Passive House design principles (Bootland, 2011).

around the whole building so as to eliminate cold corners as well as excessive heat losses. This method is another essential principle assuring a high level of quality and comfort in Passive House buildings while preventing damages due to moisture build up.

**Ecology / Sustainability.** Passive House buildings are eco-friendly by definition – they use extremely little primary energy, leaving sufficient energy resources for all future generations without causing any environmental damage. The additional energy required for their construction (embodied energy) is rather insignificant compared with the energy they save later on. This seems so obvious that there is no immediate need for additional illustrations. It is rather worth mentioning though, that the Passive House standard provides this level of sustainability for anyone wishing to build a new construction or renovating an older one at an affordable price – a contribution to protecting the environment. Be aware that the principles are all published and the design tools are made available for all architects.

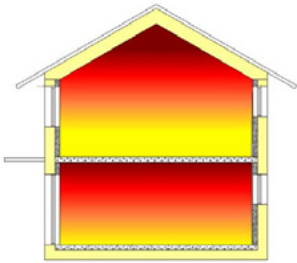
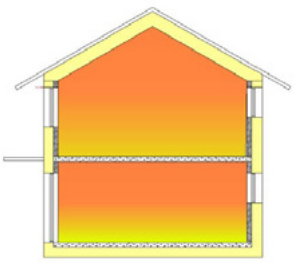
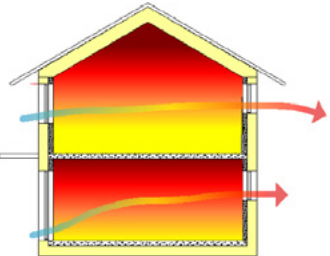
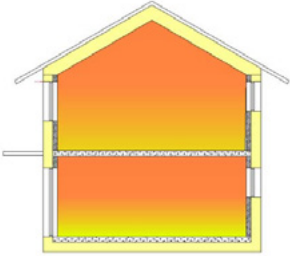
**Affordability.** Are Passive House buildings a good investment? Passive House buildings not only save money over the long term, but are also surprisingly affordable to begin with. The investment in higher quality building components required by the Passive House Standard is mitigated by the elimination of expensive heating and cooling systems. Additional financial support increasingly available in many countries makes building a Passive Houses all the more feasible.

**Measurement results.** The Passive House concept delivers – the savings are real, there is no performance gap. Passive Houses allow for space heating and cooling related energy savings of up to 90 % compared with typical building stock and over 75 % compared to average new builds. Passive Houses use less than 1.5 l of oil or 1.5 m<sup>3</sup> of gas to heat one square metre of living space for a year – substantially less than common ‘low-energy’ buildings. Vast energy savings have been demonstrated in warm climates where typical buildings also require active cooling.

**Heating & Cooling.** Make efficient use of the sun, internal heat sources and heat recovery, rendering conventional heating systems unnecessary throughout even the coldest of winters. During warmer months, Passive Houses make use of passive cooling techniques such as strategic shading to keep comfortably cool. A ventilation system imperceptibly supplies constant fresh air, making for superior air quality without unpleasant draughts. A highly efficient heat recovery unit allows for the heat contained in the exhaust air to be re-used.

The vast energy savings in Passive House buildings are achieved by using especially energy efficient building components and a quality ventilation system. There is absolutely **no cutting back on comfort**; instead, the level of comfort is considerably increased (Passivhaus Trust, 2013) (Table 1.6).

Table 1.6  
Comparison of Thermal Comfort in a Typical House and Passive House  
(Passipedia, 2014)

Thermal comfort: Movement of air	
<p><b>Typical Case</b></p> 	<p><b>Passivhaus</b></p> 
<ul style="list-style-type: none"> <li>• Feels 'draughty'</li> <li>• Heat loss through infiltration can be over a 1/3rd of total</li> <li>• Increased risk of interstitial condensation</li> </ul>	<ul style="list-style-type: none"> <li>• No draughts</li> <li>• Heat losses through leakage reduced to less than 1/10th of typical case</li> <li>• Dry building fabric</li> </ul>
Thermal comfort: Air & surface temperatures	
<p><b>Typical Case</b></p> 	<p><b>Passivhaus</b></p> 
<ul style="list-style-type: none"> <li>• Stratification</li> <li>• Clear variation between surface and air temperatures</li> </ul>	<ul style="list-style-type: none"> <li>• Even temperatures</li> <li>• Surface temperature similar to air temperature</li> </ul>

A Passive House in Germany costs around 3 % to 8 % extra, which includes the following:

- savings from the need for smaller heating and cooling systems;



- greater costs of thicker insulation, better windows and ventilation systems, certified components (especially outside Germany);
- savings in running costs, especially with rising energy prices;
- financial support available for Passive Houses in some countries (Passipedia, 2014).

A common misconception is that Passive House only applies to cold weather climates, while it actually works equally in warm and hot climates. High levels of airtightness and insulation work equally well in protecting buildings from overheating provided that there is adequate solar shading. Passive House buildings have been constructed in every major European country (see Fig. 1.33), Australia, China, Japan, Russia, Canada, the USA and South America; a research station has even been constructed to the Passive House standard in Antarctica (Passipedia, 2014).



Fig. 1.33. Spread of Passive House buildings in Europe (Passipedia, 2014).



## PHPP – Passive House Planning Package

Modelling with Passive House Planning Package (PHPP) is more than just an energy balance. The **Passive House Planning Package (PHPP)** contains everything necessary for designing a properly functioning Passive House. The PHPP prepares an energy balance and calculates the annual energy demand of the building based on the user input relating to the building's characteristics.

The main results provided by this software programme include:

- the annual heating demand [kWh/(m<sup>2</sup>a)] and maximum heating load [W/m<sup>2</sup>];
- summer thermal comfort with active cooling: annual cooling demand [kWh/(m<sup>2</sup>a)] and maximum cooling load [W/m<sup>2</sup>];
- summer thermal comfort with passive cooling: frequency of overheating events [%];
- annual primary energy demand for the whole building [kWh/(m<sup>2</sup>a)] (Passipedia, 2014).

The actual PHPP programme is based on Excel (or an equivalent spreadsheet software programme) with different worksheets containing the respective inputs and calculations for various areas (Fig. 1.34). Among other things, the PHPP deals with the following aspects:

- dimensioning of individual components (building component assemblies including U-value calculation, quality of windows, shading, ventilation, etc.) and their influence on the energy balance of the building in winter as well as in summer;

Specific building demands with reference to the treated floor area					
		156,0	m <sup>2</sup>	Requirements	Fulfilled?*
Space heating	Treated floor area	156,0	m <sup>2</sup>		
	Heating demand	14	kWh/(m <sup>2</sup> a)	15 kWh/(m <sup>2</sup> a)	yes
	Heating load	10	W/m <sup>2</sup>	10 W/m <sup>2</sup>	yes
Space cooling	Overall specif. space cooling demand		kWh/(m <sup>2</sup> a)	-	-
	Cooling load		W/m <sup>2</sup>	-	-
	Frequency of overheating (> 25 °C)	1,6	%	-	-
Primary energy	Heating, cooling, dehumidification, DHW, auxiliary electricity, lighting, electrical appliances	60	kWh/(m <sup>2</sup> a)	120 kWh/(m <sup>2</sup> a)	yes
	DHW, space heating and auxiliary electricity	39	kWh/(m <sup>2</sup> a)	-	-
	Specific primary energy reduction through solar electricity	25	kWh/(m <sup>2</sup> a)	-	-
Airtightness	Pressurization test result n <sub>50</sub>	0,2	1/h	0,6 1/h	yes

\* empty field: data missing; '' : no requirement

Fig. 1.34. Spreadsheet of Passive House Planning Package (Passipedia 2014).

- dimensioning of the heating load and cooling load;
- dimensioning of the mechanical systems for the entire building: heating, cooling, hot water provision;
- verification of the energy efficiency of the building concept in its entirety (Passipedia, 2014).

**The PHPP can be used all over the world and is now available in several languages.** Some of the translated versions contain additional calculations based on regional standards (similar to the German EnEV) in order to allow use as official verification of energy efficiency in the respective countries. Taking into account renewable energy sources and refurbishment of existing buildings (EnerPHit), the PHPP is continuously being validated and expanded in line with measured values and new findings (Passipedia, 2014).

*designPH* has been developed by the Passivhaus Institute to provide a 3D modelling interface that works together with PHPP (Passive House Planning Package). The *designPH* gives quick results using automatic analysis. The plugin provides an automatic analysis algorithm which can infer element types and area groups. Surfaces are given a colour-code so that it is possible to visually verify in the 3D model that all the heat-loss surfaces have been correctly taken into account. After importing a model to PHPP, the primary inputs on the Areas, Windows & Shading sheets will be mostly complete. This enables a result for specific space heat demand to be calculated quickly using default values, potentially saving significant time. *designPH* is an iterative design tool and also provides a preliminary simplified energy balance when the analysis process runs. This allows you to refine the design before exporting, facilitating a more effective iterative design process, and rule out poorly performing design options early on (*designPH*, 2018).

A number of built-in features in *designPH* allow for a quick model editing and a thermal analysis of a building. For editing a building model, *designPH* provides the following features (Fig. 1.35):

- Create and edit model geometry using the standard Sketchup drawing tools.
- Assign U-Values to surfaces. Once a geometric model has been created, thermal and material properties can be assigned to it. This can be done manually or by using the innovative automatic inference function that is built-in to *designPH*. This feature means that you can create a simple model and obtain a rough energy balance result without having to make any manual property assignments to the model.

- Assign properties to window elements. The window toolbar allows you to insert quickly window elements and assign them properties like frame, glazing or reveal properties.
- Consider shading elements. You can draw surfaces that are shading window components. *designPH* recognizes horizontal, vertical and horizontal shading surfaces and exports them into PHPP.
- Assign thermal bridges. You can assign lines as thermal bridges. *designPH* sums thermal bridges to ambient, floor slab or perimeter thermal bridges and exports them into PHPP.
- Assign a climate region for calculation of heat balance in the climate tab of the dialog window.
- Export to PHPP. When you have an initial design that is close to achieving the result you are aiming for, the model data can be exported to PHPP to add further detail and perform verification. The PPP file created by *designPH* can be imported into PHPP. Please see the PHPP v8 documentation for more details (*designPH*, 2018).

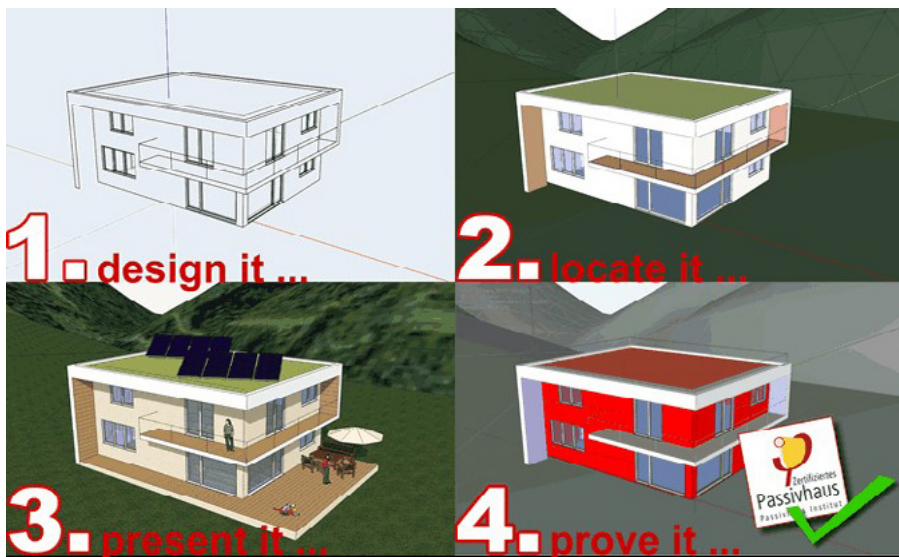






Fig. 1.35. Functions of *designPH* (*designPH*, 2018).

## Certification for buildings, products and designers

Over twenty years of experience demonstrates that the high levels of comfort and energy savings associated with the Passive House Standard is achieved through independent quality testing. All certified Passive House buildings undergo a rigorous compliance process. Certification is also available for specific components, designers / consultants & tradespeople (Table 1.7).

Table 1.7  
Certification Areas (Passivhaus Trust, 2020)

	<p><b>Buildings.</b> All proposed Passive House designs must undergo energy modelling conducted via the Passive House Planning Package (PHPP.) Tests ensure that these targets are met by completing the quality assurance process. A certificate is only issued if the exactly defined criteria have been met without exception.</p>
	<p><b>Designers.</b> Certification for designers / consultants who have the expertise to deliver Passive House buildings. The qualification covers training on PHPP, a design tool used to inform the design process and to assess or verify compliance with the Passive House Standard.</p>
	<p><b>Tradespeople.</b> Contractors have developed their basic building knowledge &amp; understand key Passive House principles such as airtightness.</p>
	<p><b>Components.</b> Certified products have undergone independent uniform testing. This allows useful quick comparisons and eases the task for designers to confidently specify high-quality, energy-efficient products.</p>

Passive House continues to expand largely across the UK and Europe. A new evaluation procedure, focusing on ‘Primary Energy Renewable’ (PER), serves as a basis for this, and the Passivhaus Institute in Germany introduced new and more demanding categories (Fig. 1.36). In addition to the existing PH standards, there are (Passive House Plus) and (Passive House Premium) standards. These new standards include the use of renewable energies.

## Passive House Plus & Premium

**PLUS:** A building certified to Passive House Plus not only drastically reduces energy use but it also produces as much energy as occupants consume, turning them into Passive House Powerhouses. The energy generated must come from renewable sources and provide enough energy to operate the building throughout the whole year.

**PREMIUM:** Far more energy is produced than required to operate the building. Passive House Premium is, therefore, a challenging goal for the particularly ambitious building owners and designers who want to go beyond what economic and ecological considerations already propose (Passivhaus Trust, 2020).

The heating demand of a Passive House may not exceed 15 kWh/(m<sup>2</sup>a). This will continue to apply, but with the introduction of the new categories, the overall demand for renewable primary energy (PER) will be used instead of the primary energy demand. In the case of the **Passive House Classic** category, this value will be 60 kWh/(m<sup>2</sup>a) at the most. A building built to **Passive House Plus** is more efficient as it may not consume more than 45 kWh/(m<sup>2</sup>a) of renewable primary energy. It must also generate at least 60 kWh/(m<sup>2</sup>a) of energy in relation to the area covered by the building. In the case of **Passive House Premium**, the energy demand is limited to just 30 kWh/(m<sup>2</sup>a), with at least 120 kWh/(m<sup>2</sup>a) of energy being generated by the building (Passipedia, 2020).

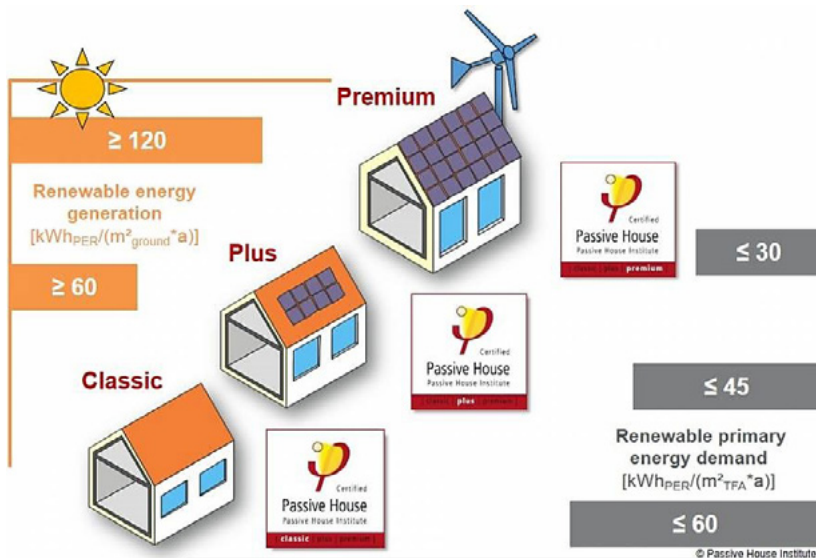


Fig. 1.36. Passive House categories (Passipedia, 2020).

## Case studies

**Case Study 1.** Hackbridge Primary 1<sup>st</sup> Passive House Plus School in the UK (Fig. 1.37).

The £ 9M (≈EUR 10M) scheme timber frame school has been designed to achieve the Passive House Plus requirement and to become the first certified Passive House Plus building in the UK. The renewables used on the school include both an extensive photovoltaic array in combination with an interseasonal ground source heat pump with bore holes, using the car park



Fig. 1.37. Hackbridge primary school (Passivhaus Trust, 2020).

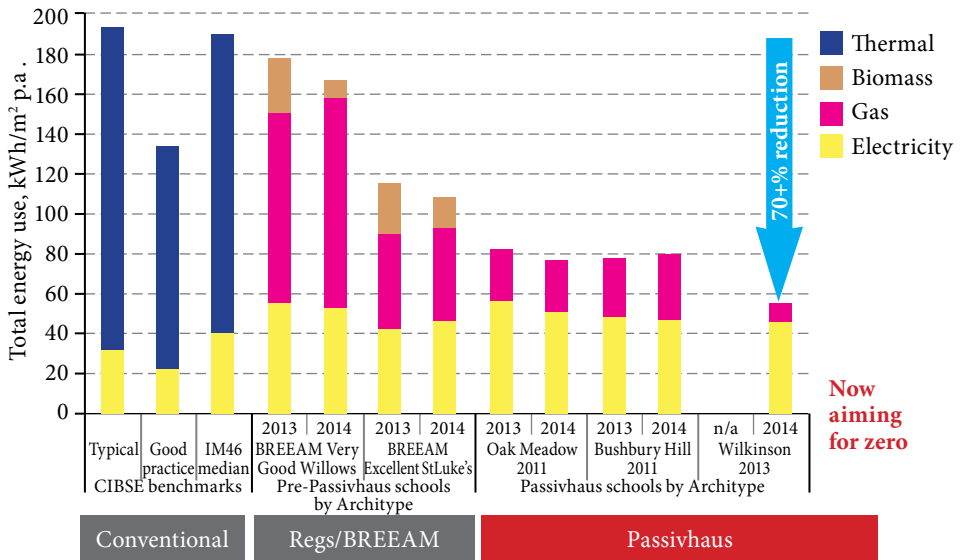


Fig. 1.38. Recorded total energy consumption (Passivhaus Trust, 2020).



as a collector. Due to its sensitive ecological setting the project has involved extensive ecological aspects, including the de-canalization of an old culvert system that has been returned to swales, wild flower gardens, sustainable drainage systems utilising swales and ponds and a biodiverse green roof under the PV array (Passivhaus Trust, 2020).

The design of this primary school and nursery follows a low embodied carbon philosophy with timber materials throughout, and the concrete ground floor slab has a high level of Ground Granulated Blastfurnace slag (GGBs) to reduce carbon impact. On top of this sits a timber frame with OSB fins framing out the main columns and beams forming a duvet zone of insulation around the structure.

Recorded total energy consumption for Passive House schools is much lower compared to typical schools (Fig. 1.38).

**Case Study 2.** Hadlow College Non-Domestic New-Build - UK Passive House Awards 2012 (Fig. 1.39).

**Project Overview:**

Name: Hadlow College RRC

Type: Teaching facility / Visitor Centre

Build type: Timber frame, GSHP, free air night-time cooling

Location: Tonbridge, Kent

Budget: £537,000 (≈EUR 603,000)

Construction costs: £1484/m<sup>2</sup> (≈EUR 1667)

Total Floor Area: 308 m<sup>2</sup>



**Fig. 1.39.** Hadlow College (Passivhaus Trust, 2020).

This iconic building is a showcase of low carbon technology constructed in 2010. One of the first educational establishments in the UK to achieve Passive House certification it uses just 10 % of the typical energy uses of an equivalent modern building. It was built using prefabricated structured insulated panels and was erected in just 3 days and water and airtight within 10 days. Located at the College Dairy on Blackmans Lane, the building is a sympathetic conversion of and extension to redundant calf sheds. It includes a visible energy monitoring display to showcase the consumption of the building (Passivhaus Trust, 2020).

The centre is designed to focus on researching, developing, influencing and supporting the sustainable rural regeneration agenda in the UK.

Its features include (Passivhaus Trust 2020):

- passive solar design;
- underfloor heating powered by a ground source heat pump, and cooling unit to prevent overheating in summer;
- triple glazed windows;
- automatic clerestory windows to aid ventilation;
- water-less urinals, low flush toilets (2 litres instead of 7), timed water-saver taps and moderated flow showers;
- walls insulated to 400 mm;
- timber frame wall panels with recycled 'blown' cellulose insulation and clad in larch from sustainably-managed forests, and no metal in the superstructure;
- a number of walls deliberately constructed of dense concrete blocks, designed to absorb the heat from low sunlight;
- provision for a green roof.

**Case study 3.** The BC Passive House Factory, Canada (Fig. 1.40).

The BC Passive House Factory is located in Pemberton, British Columbia, Canada — a small town situated within a vast mountain range. “The main inspiration for the design came from the belief that the industrial, everyday buildings that make up a vast amount of our built environment can be just as important, and well-considered, as our ‘public’ buildings”.

Encompassing 1,500 square metres, the facility was designed for the manufacture of prefabricated wall panels intended to be used for buildings



that consume minimal energy, often known as Passive House constructions. It was conceived as a 'simple, light-filled wooden box' that would exemplify the client's mission to promote wood construction, prefabrication, energy efficiency and sustainable design. It is made using the panels created by the client, BC Passive House, and thus serves as a demonstration project. It will help the company promote its super-insulated wall system that is airtight yet breathable, which helps prevent mould growth.

The firm used glue-laminated Douglas fir to construct the post-and-beam structure. Solid wood walls are made of CLT panels, and the factory ceiling consists of plywood and prefabricated timber boards.

The roof is made of prefabricated wood boards, with plywood sheathing that spans from beam to beam. A high-efficiency, heat-recovery ventilation system helps reduce carbon emissions. When comparing the structure to a similar building made of concrete, the firm estimates that the BC Passive House Factory will emit 971 less tons of carbon dioxide per year (McKnight, 2016).



**Fig. 1.40.** The BC Passive House Factory (McKnight, 2016).

## REFERENCES

- Acton Ostry Architects Inc. (2018). *Brock Commons tallwood house*.  
<https://www.actonstry.ca/project/brock-commons-tallwood-house/>
- Allen, C., Metternicht, G., & Wiedmann, T. (2018). Prioritising SDG targets: Assessing baselines, gaps and interlinkages. *Sustainability Science*, 14(2), 421–438.  
<https://doi.org/10.1007/s11625-018-0596-81>
- American Forest Foundation. (n.d.). *Building with wood is cost-effective*.  
<https://www.forestfoundation.org/building-with-wood-is-cost-effective>
- arch20. (n.d.). *Unicredit Pavilion | Michele de Lucchi*.  
<https://www.arch20.com/unicredit-pavilion-michele-de-lucchi/>
- Archdaily. (2011). *Vennesla Library and Culture House / Helen & Hard*.  
<https://www.archdaily.com/209340/vennesla-library-and-culture-house-helen-hard>
- Avellan, K. C. (2018, April 25–27). Massive wood elements and modular housing technology as innovative building concept of sustainable urban planning. Paper presented at *IABSE Conference – Engineering the Developing World*, Kuala Lumpur, Malaysia.
- Bac, D. P. (2008). *A history of the concept of sustainable development: Literature review*.  
[https://www.researchgate.net/publication/242219096\\_A\\_history\\_of\\_the\\_concept\\_of\\_sustainable\\_development\\_Literature\\_review](https://www.researchgate.net/publication/242219096_A_history_of_the_concept_of_sustainable_development_Literature_review)
- Banyan Water. (2019). *Nine categories of LEED points*.  
<https://banyanwater.com/9-categories-of-leed-points/>
- Benaïm, C. A. & Raftis, L. (2008). *The social dimension of sustainable development: Guidance and application* [Thesis submitted for completion of Master of Strategic Leadership towards Sustainability]. Blekinge Institute of Technology, Karlskrona, Sweden.
- Bergman, R., Puettmann, M., Taylor, A. ., & Skog, K. E. (2014). The carbon impacts of wood products. *Forest Products Journal*, 64(7/8), 220–231.  
<https://doi.org/10.13073/FPJ-D-14-00047>
- Bioeconomy BW. (n.d.). *Sustainable building construction: municipalities go wood*.  
<https://www.bioeconomie-bw.de/en/articles/news/sustainable-building-construction-municipalities-go-wood>
- Block, I. (2019). *Zaha Hadid Architects wins approval for world's first all-timber stadium*.  
<https://www.dezeen.com/2019/12/27/worlds-first-timber-stadium-zaha-hadid-architects/>
- Bootland. (2011). *Passivhaus principles*. <http://www.passivhaustrust.org.uk/>
- Börjesson, P. & Gustavsson, L. (2000). Greenhouse gas balances in building construction: wood versus concrete from life-cycle and forest land-use perspectives. *Energy Policy*, 28, 575–588. [https://doi.org/10.1016/S0301-4215\(00\)00049-5](https://doi.org/10.1016/S0301-4215(00)00049-5)

- Bourdeau, L. (1999). Sustainable development and the future of construction: a comparison of visions from various countries. *Building Research & Information*, 27(6), 354–366. <https://doi.org/10.1080/096132199369183>
- BRE Global. (2016). *BREEAM Communities technical manual*. <https://www.breeam.com/communitiesmanual>
- BRE. (2015). *Case study: Sustainable timber on BREEAM Outstanding adapt enterprise centre*. <https://www.bregroup.com/buzz/case-study-sustainable-timber-on-breeam-outstanding-adapt-enterprise-centre/>
- BRE. (2020). *Building a better world together*. <https://www.bregroup.com>
- BREEAM. (2020). *What is BREEAM?* <https://www.breeam.com>
- Brodhag, C. & Taliere, S. (2006). Sustainable development strategies: Tools for policy coherence. *Natural Resources Forum*, 30, 136–145. <https://doi.org/10.1111/narf.2006.30.issue-2>
- Campagnolo, L., Carraro, C., Eboli, F., Farnia, L., Parrado, R., & Pierfederici, R. (2018). The ex-ante evaluation of achieving sustainable development goals. *Social Indicators Research*, 136, 73–116. <https://doi.org/10.1007/s11205-017-1572-x>
- Chouinard, Y., Ellison, J., & Ridgeway, R. (2011). *The sustainable economy*. Harvard Business Review. <https://hbr.org/2011/10/the-sustainable-economy>
- Daly, H. E. (1992). U.N. conferences on environment and development: retrospect on Stockholm and prospects for Rio. *Ecological Economics: The Journal of the International Society for Ecological Economics*, 5, 9–14. [https://doi.org/10.1016/0921-8009\(92\)90018-N](https://doi.org/10.1016/0921-8009(92)90018-N)
- designPH. (2018). *designPH and PHPP*. <https://designph.org/>
- Diesendorf, M. (2000). Sustainability and sustainable development. In D. Dunphy, J. Benveniste, A. Griffiths & P. Sutton (Eds.), *Sustainability: The corporate challenge of the 21st century* (pp. 19–37). Sydney: Allen & Unwin.
- DMCC. (2020). *What is LEED?* <https://www.dmcc.ae/green-building-education>
- Dovetail. (2018). *Unterdorf Elementary School, Höchst*. <http://www.wooddesignandbuilding.com/unterdorf-elementary-school-hochst/>
- EN 16351: 2015 *Timber structures - Cross laminated timber - Requirements*.
- Environmental and Energy Study Institute. (2014). *How better recycling can minimize waste and boost the economy*. Washington DC: Environmental and Energy Study Institute.
- Environmental Protection Agency (EPA). (2019). *Definition of green building*. <https://archive.epa.gov/greenbuilding/web/html/about.html>
- European Commission. (2016). *The European construction sector. A global partner*. [https://ec.europa.eu/growth/content/european-construction-sector-global-partner-0\\_en](https://ec.europa.eu/growth/content/european-construction-sector-global-partner-0_en)
- Forest Europe. (2015). *State of Europe's forests 2015 report*. <https://foresteurope.org/state-europes-forests-2015-report/>
- Franzini, F., Toivonen, R., & Toppinen, A. (2018). Why not wood? Benefits and barriers of wood as a multistory construction material: Perceptions of municipal civil servants

- from Finland. *Buildings*, 8, 159. <https://doi.org/10.3390/buildings8110159>
- Grozdanic, L. (2017). *Milan's striking wooden UniCredit building is powered by the sun*. <https://inhabitat.com/milans-striking-wooden-unicredit-building-is-powered-by-the-sun/>
- Hospitalitynet. (2020). *Moxy Copenhagen*. <https://www.hospitalitynet.org/announcement/41001090/moxy-copenhagen.htm>
- InnoBYG. (2017). *Multi-storey wooden buildings – State of the Art*.
- Instabuilt. (n.d.). *DE glue laminated timber*. <https://instabuilt.com/de/products/de-glue-laminated-timber/>
- International Monetary Fund. (2014). Is it time for an infrastructure push? The macroeconomic effects of public investment. In *World Economic Outlook 2014*. Washington DC: IMF.
- Kates, R. W., Clark, W. C., Corell, R., Hall, J. M., Jaeger, C. C., Lowe, I., ... Dickson, N. M. (2001). Sustainability science. *Science*, 292, 641–642. <https://doi.org/10.1126/science.1059386>
- Kibert, J. (1994). Establishing principles and a model for sustainable construction. In *CIB TG 16, Sustainable Construction*. Tampa, Florida, USA.
- Kolk, A. (2016). The social responsibility of international business: From ethics and the environment to CSR and sustainable development. *Journal of World Business*, 51(1), 23–34. <https://doi.org/10.1016/j.jwb.2015.08.010>
- KTH. (n.d.). *Toolbox – Learning for sustainable development*. <https://www.kth.se/en/om/miljo-hallbar-utveckling/utbildning-miljo-hallbar-utveckling/verktygslada/sustainable-development>
- Kumar, S., Raizada, A., & Biswas, H. (2014). Prioritising development planning in the Indian semi-arid Deccan using sustainable livelihood security index approach. *International Journal of Sustainable Development & World Ecology*, 21, 4. <https://doi.org/10.1080/13504509.2014.886309>
- Laurent, A. B., Meer, Y., & Villeneuve, C. (2018). Comparative life cycle carbon footprint of a non-residential steel and wooden building structures. *Current trends in forest research*, CTFR-128.
- Lobo, M.-J., Pietriga, E., & Appert, C. (2015). An evaluation of interactive map comparison techniques. In *Proceedings of the 33rd Annual ACM Conference on Human Factors in Computing Systems - CHI '15* (pp. 3573–3582).
- Malthus, T. R. (1798). *An essay on the principle of population*.
- McKnight, J. (2016). *Hemsworth creates all-wood Passivhaus factory in a mountainous region of Canada*. <https://www.dezeen.com/>
- McPartland, R. (2017). *Norway to build world's tallest timber building*. <https://www.thenbs.com/>
- Mensah, J. (2019). Sustainable development: Meaning, history, principles, pillars, and implications for human action: Literature review. *Cogent Social Sciences*, 5(1). <https://doi.org/10.1080/23311886.2019.1653531>

- Metsä Wood's Kerto-Qp. (n.d.). *Laminated veneer lumber*.  
<https://www.metsawood.com/global/Products/kerto/Pages/Kerto.aspx>
- Ministry of the Environment, Nature Agency. (2014). *Guidance No. 9467 of 25 June 2014 Ensuring sustainable wood in public contracts for goods, services and works*. Denmark.
- Myers, D. (2013). *Construction economics: A new approach* (3rd ed.). Routledge.
- New Nordic Timber. (2019). *Build in wood 2019*.  
<https://newnordictimber.com/articles/build-in-wood-2019>
- Nordic Structures. (2017). *John W. Olver Design Building*.  
<https://www.nordic.ca/en/projects/structures/umass-design-building>
- Oliver, C. D., Nassar, N. T., Lippke, B. R., & McCarter, J. B. (2014). Carbon, fossil fuel, and biodiversity mitigation with wood and forests. *Journal of Sustainable Forestry*, 33, 248–275. <https://doi.org/10.1080/10549811.2013.839386>
- Parker, J. (2012). *BSRIA Report: The value of BREEAM*. <https://tools.breeam.com>
- Passipedia. (2014). *PHPP – Passive House Planning Package*. <https://passipedia.org/>
- Passivhaus Trust. (2020). *Why choose Passivhaus?* <https://passivhaustrust.org/>
- Paxton, L. (1993). *Enviro Facts 3: Sustainable development*. Howick, South Africa: Environmental Education Association of Southern Africa.
- Petersen, A. K. & Solberg, B. (2002). Greenhouse gas emissions, life-cycle inventory and cost-efficiency of using laminated wood instead of steel construction. Case: beams at Gardermoen airport. *Environmental Science & Policy*, 5, 169–182.  
[https://doi.org/10.1016/S1462-9011\(01\)00044-2](https://doi.org/10.1016/S1462-9011(01)00044-2)
- Quebec Wood Export Bureau (QWEB). (2015). *Wood construction technologies in Quebec, Canada*. [http://www.quebecwoodexport.com/images/stories/pdf/Catalogue\\_AN\\_13-04-2016.pdf](http://www.quebecwoodexport.com/images/stories/pdf/Catalogue_AN_13-04-2016.pdf)
- Radkau J. (2012). *Wood: A history*. Polity.
- Skullestad, J. L., Bohne, R. A. , & Lohne, J. (2016). High-rise timber buildings as a climate change mitigation measure – A comparative LCA of structural system alternatives. *Energy Procedia*, 96, 112–123. <https://doi.org/10.1016/j.egypro.2016.09.112>
- Smith, C. & Smith, H. (2016). *USGBC announces new LEED credits for structural wood building materials. The Decision is a boost to the expanding use of wood in public and private projects*.  
<https://www.lexology.com/library/detail.aspx?g=b11a41ca-7b09-4562-898f-bebbcadf14fd>
- Smith, R., Griffin, G., & Talbot, R. (2015). *Solid timber construction: Process, practice, performance*. University of Utah.
- Stora Enso. (2020). *CLT by Stora Enso. Wood: the world's oldest and yet most modern building material*.
- Sustainable Forestry Initiative. (2016). *How to count your certified products for a LEED point*. [https://www.sfprogram.org/wp-content/uploads/LEED\\_ACP\\_April2016\\_Final.pdf](https://www.sfprogram.org/wp-content/uploads/LEED_ACP_April2016_Final.pdf)
- The Passive House Institute (PHI). (2015). *The Passive House Institute*.  
<https://passivehouse.com/>


- The World Bank. (n.d.). *Forests generate jobs and incomes*. <https://www.worldbank.org/en/topic/forests/brief/forests-generate-jobs-and-incomes>
- UN Global Compact. (n.d.). *Social sustainability*. <https://www.unglobalcompact.org/what-is-gc/our-work/social>
- United Nations (UN). (2015). *Sustainable development goals*. <https://sustainabledevelopment.un.org/?menu=1300>
- United Nations. (n.d.). *United Nations Environmental Programme (UNEP)*. <https://www.unenvironment.org/about-un-environment/what-we-do>
- University of British Columbia and Acton Ostry Architects Inc. (n.d.). *Brock Commons*. [https://www.sciencemag.org/sites/default/files/images/092316NF\\_woodenSkyscrapers\\_DRUPAL.jpg](https://www.sciencemag.org/sites/default/files/images/092316NF_woodenSkyscrapers_DRUPAL.jpg)
- University of Mary Washington. (n.d.). *Economic sustainability*. <https://sustainability.umw.edu/areas-of-sustainability/economic-sustainability/#:~:text=Economic%20sustainability%20refers%20to%20practices,sector%20through%20the%20UMW%20foundation>
- University of Massachusetts. (2018). *John W. Olver Design Building earns LEED Gold certification*. <http://www.umass.edu/architecture/news/john-w-olver-design-building-earns-leed-gold-certification>
- Vogler, J. (2007). The international politics of sustainable development, In G. Atkinson & S. Dietz (Eds.). *Handbook of sustainable development* (Chapter 26). Edward Elgar Publishing Limited, Cheltenham.
- Weitz, N., Carlsen, H., Nilsson, M., & Skånberg, K. (2017). Towards systemic and contextual priority setting for implementing the 2030 agenda. *Sustainability Science*, 13(2), 531–548. <https://doi.org/10.1007/s11625-017-0470-0>
- Whole Building Design Guide (WBDG). (2019). *Green building standards and certification systems*. <https://www.wbdg.org>
- Wood for Good. (n.d.). *Wood construction reduces stress and offers a healthy living environment*. <https://woodforgood.com/news-and-views/2014/05/15/wood-construction-reduces-stress-and-offers-a-healthy-living-environment/>
- WoodWorks. (n.d.). *Cost-efficient wood framing leads to energy-efficient schools*. <https://www.woodworks.org/wp-content/uploads/CS-Bethel2.pdf>
- WoodWorks. (n.d.). *Green building and wood products*. <https://www.woodworks.org/wp-content/uploads/Green-Building-Wood-Products-CEU.pdf>
- World Economic Forum. (2016). *Shaping the future of construction – a breakthrough in mindset and technology*. [http://www3.weforum.org/docs/WEF\\_Shaping\\_the\\_Future\\_of\\_Construction\\_full\\_report.pdf](http://www3.weforum.org/docs/WEF_Shaping_the_Future_of_Construction_full_report.pdf)
- World Commission on Environment and Development. (1987). *Our Common Future* (Report). <https://sustainabledevelopment.un.org/content/documents/5987our-common-future.pdf>
- World Steel Association. (2015). *World steel in figures 2015*. Brussels: World Steel Association.



# Chapter 2

## Wood as a Construction Material

*David Trujillo*

- 2.1. Introduction: Timber in the Climate Emergency**
  - 2.2. Macroscopic Characteristics of Wood**
  - 2.3. Microscopic Characteristics of Wood**
  - 2.4. Physical Properties of Wood**
  - 2.5. Mechanical and Elastic Properties**
  - 2.6. Durability of timber**
  - 2.7. Variability**
  - 2.8. Behaviour in Fire**
- References**
- 

## CHAPTER 2. WOOD AS A CONSTRUCTION MATERIAL

---

**David Trujillo,**

School of Energy, Construction and Environment, Coventry University

### Acknowledgement

---

The author would like to thank Dr Morwenna Spear from Bangor University for sharing her knowledge about microscopic characteristics of timber.

## 2.1. INTRODUCTION: TIMBER IN THE CLIMATE EMERGENCY

---

According to the Intergovernmental Panel on Climate Change (Masson-Delmotte, 2018), a 1.5 °C increase in annual global temperature since pre-industrial times as a consequence of man-made climate change will place a lot of pressure on numerous natural, human and managed systems as defined. Nevertheless, trying to limit temperatures increases to just 1.5 °C will require a very significant and rapid change to our global economy and our consumption patterns. The IPCC presents four possible pathways for this transition. Some of these pathways rely strongly on Bioenergy with Carbon Capture and Storage (BECCS), which fundamentally consists of using plants to capture carbon, then transforming the biomass into energy but ensuring that the CO<sub>2</sub> released is captured and stored permanently on land or in the ocean.

When this scenario is coupled with UN projections that there will be 2.3 billion more urban dwellers by 2050 (United Nations, 2018), it is likely that this rapid urbanisation will require a great expansion in housing, buildings



and infrastructure. It is feared that the development of this new infrastructure could claim between one and two thirds of the remaining carbon budget (Churkina, 2020). In light of this, a recent report from C40 cities (C40 cities, Arup and University of Leeds, 2019) recommends a 35 % reduction in steel usage, a 56 % reduction in cement usage and that 90 % of all new residential buildings and 70 % of all new commercial buildings are made from timber by 2030. Churkina et al. (2020) also propose that if buildings were to be made from bio-based materials (e.g. timber, bamboo, hemp, etc.), not only would the carbon released during construction be significantly reduced, but the buildings themselves could act as carbon stores (Churkina, 2020). Humanity has been building with timber and other bio-based materials for millennia because it was for many applications the best material available. In the 21st century, this still remains the case. Figure 2.1 shows commercial timber plantation.



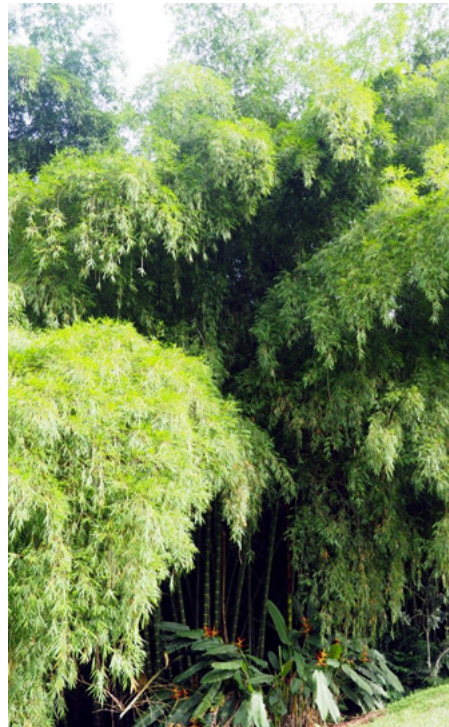
**Fig. 2.1.** Commercial timber plantation in Scotland, UK. © David Trujillo.

## 2.2. MACROSCOPIC CHARACTERISTICS OF WOOD

What is wood? The question seems trivial, but it is not so simple when considering the variety of plants that can generate wood-like products. For example, we do not call ‘wood’ the wood-like products that we can obtain from palm trees (belonging to the *Arecaceae* family of monocotyledons - Fig. 2.2) or from bamboo (belonging to the *Poaceae* or *Gramineae* family of monocotyledons - Fig. 2.3). It is commonly accepted that wood is obtained from plants that exhibit secondary growth (i.e. they become wider over time), these are *Gymnosperms* and *Angiosperms*, which are more commonly known as softwoods and hardwoods respectively. The names hardwood and softwood can be deceptive, as not all hardwoods are stronger than all softwoods, though in general hardwoods are denser. Hardwoods come from broadleaved trees



**Fig. 2.2.** Coconut palms (*Cocos nucifera*). © David Trujillo.



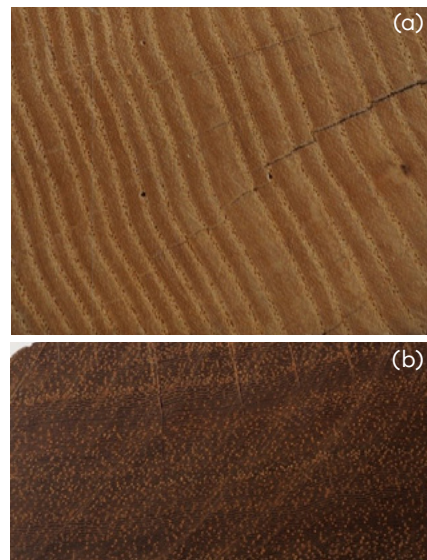
**Fig. 2.3.** Giant bamboo (*Guadua angustifolia* Kunth). © David Trujillo.



**Fig. 2.4.** Two intertwined types of broadleaf trees: oak (*Quercus robur*) and horse-chestnut (*Aesculus hippocastanum*). ©David Trujillo.

that generally have a broad crown (see Fig. 2.4). In temperate regions most broadleaved trees are deciduous (i.e. they lose their leaves in winter), though in the tropics they are evergreens. There are some 20,000 commercial species of hardwoods. Softwood comes from trees with needle-like leaves, which generally have narrow, conical crowns. There are around 650 species. In European codes and standards (e.g. EN 338), hardwoods are denoted with prefix 'D' for 'deciduous', whereas softwoods are denoted with prefix 'C' for 'coniferous'.

Softwoods constitute the bulk of the worldwide construction industry. In



**Fig. 2.5.** Tangential section through two hardwood timbers: (a) Ash and (b) Ekki. © David Trujillo.

Europe and North America, timber structures tend to be made from softwood timber. Instead, hardwood tends to be more costly and therefore reserved for applications that require greater hardness, such as floors, or greater durability, such as window frames, cladding or external decking. Tables 2.1, 2.2 and 2.3 and Figure 2.5 provide some examples of common softwood and hardwood timbers.

Table 2.1  
Examples of Softwood Species (TRADA, 2015)

Common name	Scientific name	Density at 15 % moisture content (kg/m <sup>3</sup> )
Cedar, Western red	<i>Thuja picata</i>	390
Douglas fir	<i>Pseudotsuga menziesii</i>	530
Larch, European	<i>Larix decidua</i>	550
Pine, Canadian red	<i>Pinus resinosa</i>	450
Pine, Caribbean pitch	<i>Pinus caribaea</i>	720
Redwood, European	<i>Pinus sylvestris</i>	510
Spruce, Sitka	<i>Picea sitchensis</i>	450
Whitewood, European	<i>Picea abies, Abies alba</i>	470
Yew	<i>Taxus baccata</i>	670

Table 2.2  
Examples of Temperate Hardwood Species (TRADA, 2015)

Common name	Scientific name	Density at 15 % moisture content (kg/m <sup>3</sup> )
Ash, European (see Fig. 4(a))	<i>Fraxinus excelsior</i>	710
Beech, European	<i>Fagus sylvatica</i>	720
Birch, European	<i>Betula pendula</i>	670
Cherry, European	<i>Prunus avium</i>	630
Chestnut, sweet	<i>castanea sativa</i>	560
Elm, European	<i>Ulmus spp</i>	560
Oak, European	<i>Quercus robur</i>	720
Walnut, European	<i>Juglans regia</i>	670

Table 2.3  
Examples of Tropical Hardwood Species (TRADA, 2015)

Common name	Scientific name	Density at 15 % moisture content (kg/m <sup>3</sup> )
Balau	<i>Shorea spp</i>	980
Balsa	<i>Ochroma lagopus</i>	160
Ebony	<i>Diospyros spp</i>	1160
Ekki/azobé (see Fig. 4(b))	<i>Lophira alata</i>	1070
Iroko	<i>Milicia excels, M. Regia, Chlorophora excels, Chlorophora regia</i>	660
Lignum vitae	<i>Guaiacum spp</i>	1230
Sapele	<i>Entandrophragma cylindricum</i>	640
Teak	<i>Tectona grandis</i>	660
Utile	<i>Entandrophragma utile</i>	660

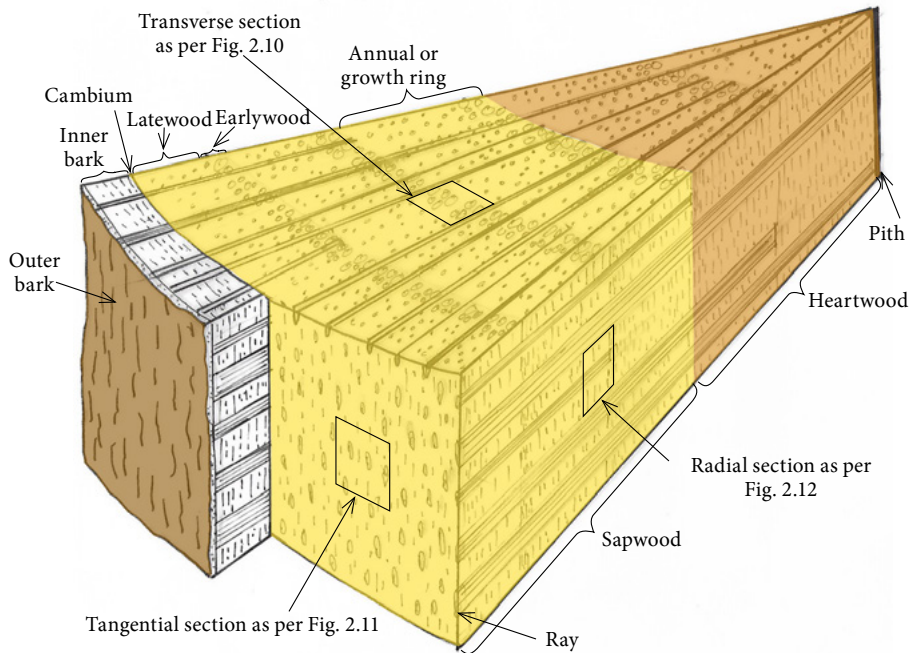
### Parts of the trunk

Wood is sourced from the stem, or trunks, of trees that exhibit secondary growth. The characteristics of a tree trunk are discussed hereafter – also refer to Fig. 2.6. The wood within the trunk provides three fundamental functions: 1) it transports water solutions (sap) from the roots to the leaves in the branches, 2) it stores carbohydrates, and 3) it provides mechanical strength. Sugars that are synthesised in the leaves flow as dissolved sugars along the inner bark and migrate from the bark into the trunk. The outer bark protects the wood and the inner bark. There is a thin layer of cells between the bark and the wood called *cambium*. Throughout the life of the tree, cambium cells divide to form wood towards the inside and bark towards the outside – this is what is referred to as secondary growth. The activity of these cells varies throughout the year, especially in temperate regions, as they will only be active during spring and summer, which leads to the distinctive growth rings visible in timber. In tropical regions growth may be continuous, unless interrupted by drier seasons.

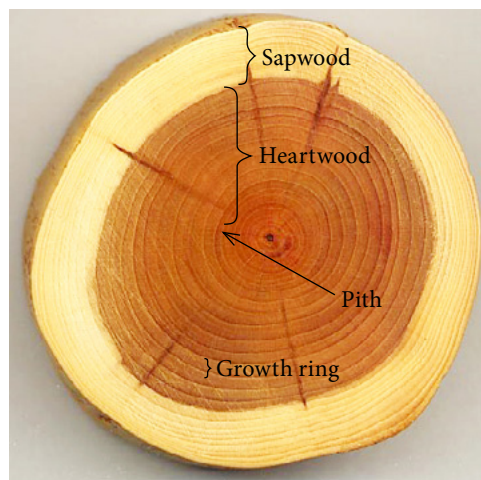
As trees grow older the inner cells within the wood cease to conduct sap and store sugars, instead, in some cases this wood starts to accumulate tannins and oils. This inner wood is known as heartwood and in some species may



have a distinctive colour – refer to Fig. 2.7. In contrast the outer wood is known as sapwood. The absence of sugars and presence of oils and tannins makes heartwood more durable than sapwood.



**Fig. 2.6.** Diagrammatic illustration of a wedge-shaped segment cut from a hardwood tree, showing principal structural features – adapted from a figure produced by the Building Research Establishment.

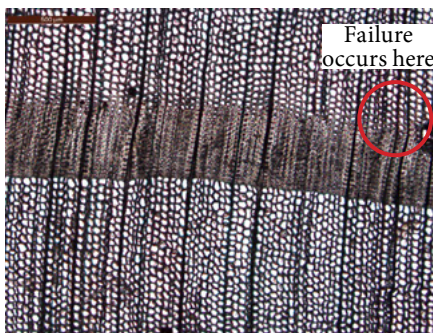


**Fig. 2.7.** Section through Yew wood (*Taxus baccata*). The dark radial lines are small knots. Source: Wikimedia.

## 2.3. MICROSCOPIC CHARACTERISTICS OF WOOD

The differences between softwoods and hardwoods are also visible at a microscopic level. Softwoods tend to be simpler and are predominantly composed of tracheids and parenchyma. In the living tree, tracheids provide a dual function to transport sap and provide mechanical support, whilst parenchyma cells transport and store sugar. Figure 2.8 shows a transverse section of Scots pine, showing earlywood or springwood (i.e. wood that grows in spring) and latewood or summerwood (i.e. wood that grows in summer). The earlywood tracheids have larger cross section than the latewood tracheids, so appear bright in this image. Some softwoods also include resin canals. A resin canal is enclosed in the red circle. The darker lines crossing the image vertically are rays, which contain the parenchyma cells. Rays transport sugars between the inner bark and the wood.

Hardwoods are a great deal more complex. They have evolved to have cells that undertake specialised functions. Sap is transported through vessels, and mechanical resistance is provided by fibre cells. Typically, rays are also more prominent in hardwoods than in softwoods. Figure 2.9 presents a transverse section of beech, showing earlywood (with large open vessel cells) and latewood (with smaller diameter vessel cells). The vessels in earlywood are larger than in latewood. The rays in beech are also much more prominent than in the Scots pine, with some being many cells wide (e.g. large ray on left hand side), while others are narrower (central region of image).

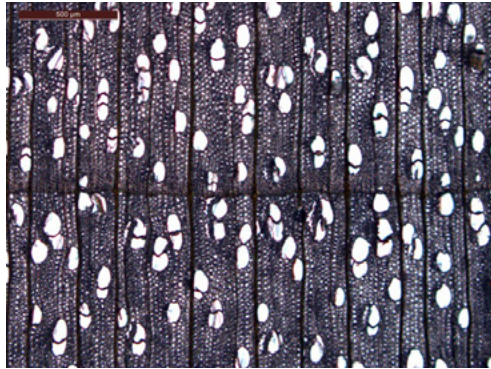


**Fig. 2.8.** Transverse section through a Scots pine. Morwenna Spear  
© Chris Miles.

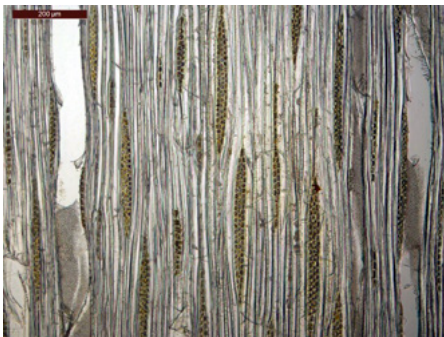


**Fig. 2.9.** Transverse section through beech. Morwenna Spear  
© Chris Miles.

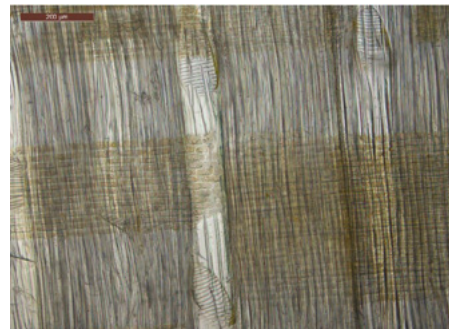
Figures 2.10, 2.11 and 2.12 show respectively transverse, tangential longitudinal and radial longitudinal sections for birch. Figure 2.11 shows a large vessel on the left-hand side (the white space). The vessel has a ‘perforation plate’ near the bottom of the image. These act as connections between one wide vessel cell and the next. Several rays are shown in cross section, with 2-3 parenchyma cells in width and 10-30 parenchyma cells in height. Figure 2.12 shows a tall ray running horizontally across the image, with many rows of brick-like parenchyma cells. A vessel cell is visible in the middle of the image. In this instance the perforation plates appear like ladders.



**Fig. 2.10.** Transverse section through birch. Morwenna Spear © Chris Miles.



**Fig. 2.11.** Tangential longitudinal section through birch. Morwenna Spear © Chris Miles.



**Fig. 2.12.** Radial longitudinal section through birch. Morwenna Spear © Chris Miles.



## 2.4. PHYSICAL PROPERTIES OF WOOD

### 2.4.1. Moisture Content

As is the case for all life forms, water is an essential component of a tree when it is alive. When a tree is felled, a significant part of the wood's mass will be water. Within the wood's cell, water is held in two significant ways: free water, which is held in the cell cavity, and bound water that is held in the cell walls. The amount of water contained in a wood specimen is called the 'moisture content', which in accordance to EN 13183-1 is calculated as follows:

$$\omega = \frac{m_1 - m_0}{m_0} \times 100,$$

where  $\omega$  is the moisture content expressed as a percentage (sometimes also expressed as MC);  $m_1$  is the mass of a wood specimen before drying;  $m_0$  is the oven-dry mass of the specimen; drying is undertaken in an oven at (103E2) °C.

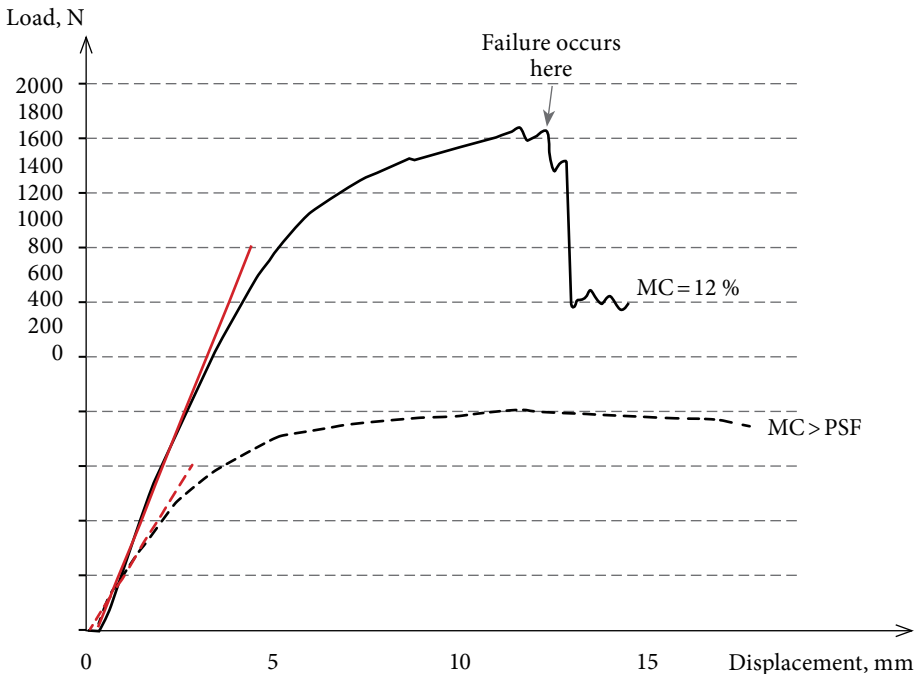
Timber is a hygroscopic material, which means that it releases and absorbs moisture from the atmosphere until achieving an equilibrium with the water vapour pressure of the surrounding air. After felling, water will be released to the atmosphere. At first it will be free water. This drying process continues until a moisture content of around 30 % is attained, which is known as the Fibre Saturation Point (FSP) – it should be noted that FSP values are species dependant. At this point, all free water has been released, and any further drying will occur as a consequence of releasing bound water to the atmosphere.

When wood has a moisture content below the FSP, significant changes start occurring to the wood. Most noticeably, dimensional changes start to take place, these may manifest themselves as radial and tangential shrinkage, which may lead to warping and splitting. Mechanical properties also change significantly, as will be discussed later. The wood will continue drying, but unless it is placed in an oven as described above, it will not reach a 0 % moisture content. Instead, it will reach an equilibrium with the environment dependent on water vapour pressure of the atmosphere, hence it is dependant on the temperature and relative humidity of the surrounding environment. This moisture content is known as the Equilibrium Moisture Content (EMC).

As it dries, wood gains strength and stiffness, yet it also becomes more brittle.

Figure 2.13 shows fairly typical test results of two similarly sized clear wood specimens that were subjected to a bending test. The solid line displays the behaviour of a dry specimen ( $\omega = 12\%$ ), whilst the dashed line displays the behaviour of a wet specimen ( $\omega \approx 40\%$ ). The red lines represent the linear elastic range for each specimen. Note that the dry specimen is both stiffer (i.e. the gradient of the red line is steeper) and stronger (i.e. the maximum load attained is higher). Note also that once the dry specimen reaches its maximum load failure occurs soon after.

Moisture content also affects the durability of timber. At moisture content above 20%, fungi can develop in the timber. Timber that has suffered fungal attack is also more susceptible to insect attack. Therefore, the primary requirement to ensure timber can be considered a durable material is to keep its moisture content below 20%.



**Fig. 2.13.** Comparison of bending test results for dry and wet timber.

## 2.4.2. Density

Density is fundamentally the ratio between mass and volume. Density in timber correlates well to numerous other properties such as strength, stiffness and fire-resistance, it therefore is a very useful property to measure. Density is species dependent. It is also fairly easy to measure provided the moisture content is known. Otherwise, it is impossible to know what percentage of the mass is water and what is wood. Similarly, when moisture content is below the FSP, timber undergoes dimensional changes, which changes the volume of a specimen. Therefore, density measurements are affected by moisture content. There are several ways that can be used to determine and report density, Table 2.4 lists some of them. Tables 2.1, 2.2 and 2.3 list the densities for a range of species. Tables 2.5 and 2.6 provide 5<sup>th</sup> percentile and mean densities for a range of timber strength classes in accordance to EN 338:2016.

Table 2.4  
Different Ways to Determine and Report Density

Name	Symbol	Equation	Commentary
Basic density	$\rho_b$ or $D_b$	$\rho_b = \frac{m_0}{V_w}$	In some scientific contexts basic density is a preferred measurement because oven-dry mass ( $m_0$ ) and water saturated volume ( $V_w$ ) are both stable values.
Oven dry density	$\rho_0$	$\rho_b = \frac{m_0}{V_0}$	This is also a favoured measurement in scientific contexts because it is also fairly stable. In this context both volume and mass are measured at 0 % moisture content.
Density at 12 % moisture content	$\rho_{12}$	$\rho_{12} = \frac{m_{12}}{V_{12}}$	This is a preferred measurement in engineering because it is representative of typical in-service conditions.
5 percentile density	$\rho_k$	Calculated from a sample's $\rho_{12}$ values	Used in Eurocode 5 connection strength and fire resistance calculations. Refer also to Tables 5 and 6.
Mean density	$\rho_{\text{mean}}$	Calculated from a sample's $\rho_{12}$ values	Used in Eurocode 5 connection stiffness calculations. Maybe used for calculation of self-weight. Refer also to Tables 5 and 6.

Table 2.5  
Density in kg/m<sup>3</sup> According to Strength Classes for Softwood Based  
on Edgewise Bending Tests (Adapted from EN 338:2016)

Strength class	5 percentile density ( $\rho_k$ )	Mean density ( $\rho_{mean}$ )
C14	290	350
C16	310	370
C18	320	380
C20	330	400
C22	340	410
C24	350	420
C27	360	430
C30	380	460
C35	390	470
C40	400	480
C45	410	490
C50	430	520

Table 2.6  
Density in kg/m<sup>3</sup> According to Strength Classes for Hardwood Based  
on Edgewise Bending Tests (Adapted from EN 338:2016)

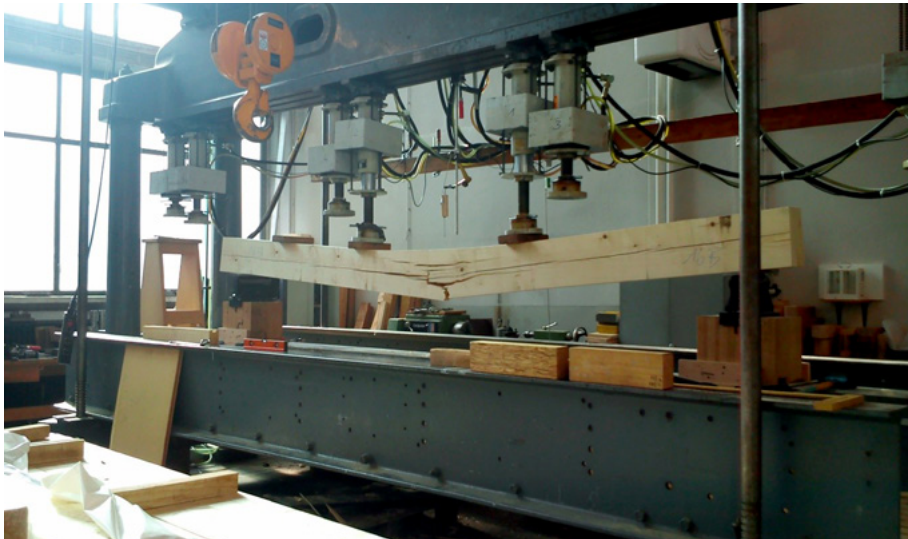
Strength class	5 percentile density ( $\rho_k$ )	Mean density ( $\rho_{mean}$ )
D18	475	570
D24	485	580
D27	510	610
D30	530	640
D35	540	650
D40	550	660
D45	580	700
D50	620	740
D55	660	790
D60	700	840
D65	750	900
D70	800	960
D75	850	1020
D80	900	1080

## 2.5. MECHANICAL AND ELASTIC PROPERTIES

Four-point bending test to a piece sawn softwood is shown in Fig. 2.14.

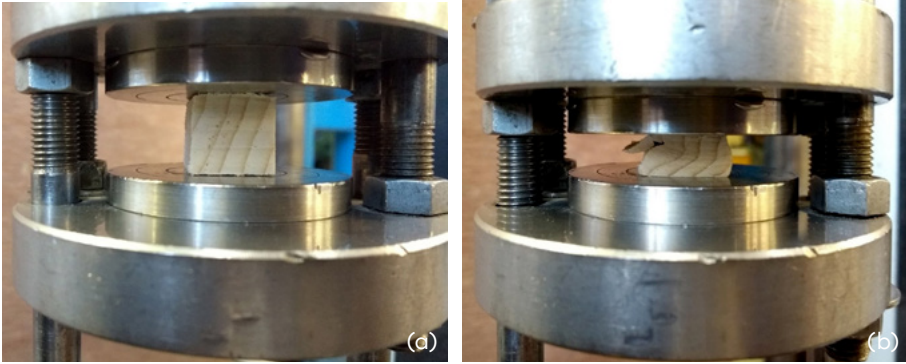
### 2.5.1. Anisotropy

As observed in Figs. 2.8 to 2.12, wood is constituted primarily of longitudinal cells. Their distribution obeys the functional needs of the tree whilst alive, for example resisting wind-loads and transporting water to the branches and leaves. The outcome of this is that timber is an anisotropic material, i.e. its properties are direction dependant. Consider Fig. 2.16, which represents the stress-strain behaviour of two clear-wood specimens subject to compression stresses. The continuous line represents the behaviour of a specimen loaded perpendicular to the direction of growth of the tree, also termed ‘compression perpendicular to the grain’. Figure 2.15 shows the way in which a specimen tested in compression perpendicular to the grain ‘fails’. Fundamentally the

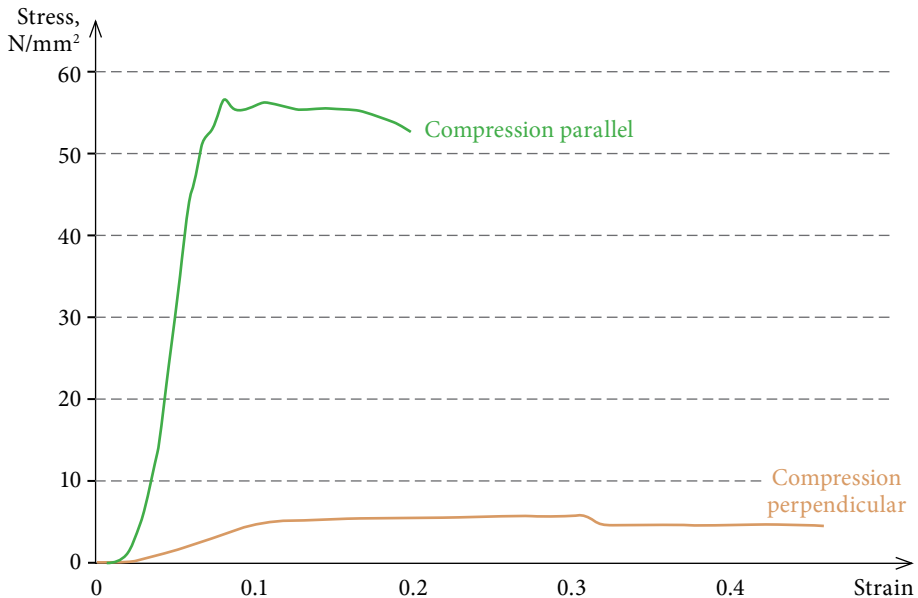


**Fig. 2.14.** Four-point bending test to a piece sawn softwood at the University of Stuttgart. © David Trujillo.

specimen is ‘densified’. The cavity within the cells is crushed. The dashed line in Fig. 2.16 represents the behaviour of a specimen loaded parallel to the grain. Note that it resists a stress about ten times larger than compression perpendicular to the grain, and it is also much stiffer. Figure 2.17(a) represents a typical failure mode for a clear-wood specimen loaded in compression parallel to the grain. In this instance, failure occurs through the buckling of the cells. It requires significantly more stress to induce this failure mode, which explains the differences visible in Fig. 2.16.



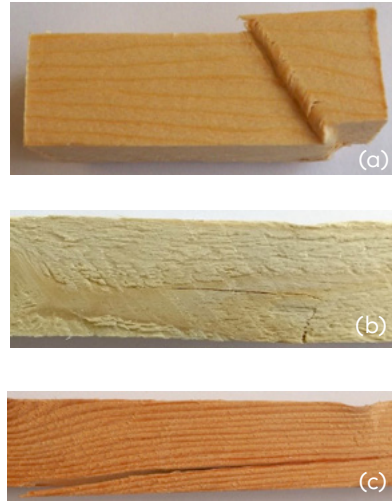
**Fig. 2.15.** A wood specimen subjected to compression perpendicular to the grain: (a) before testing, and (b) afterwards.



**Fig. 2.16.** Graph representing stress-strain behaviour for wood in compression parallel and perpendicular to grain.

There are also very significant differences in tensile strength parallel or perpendicular to the grain. This is noticeable in circumstances where tensile stresses are induced, such as in bending tests. Figure 16(b) and (c) represent the failure modes of two timber specimens. Figure 2.17(b) represents a fairly typical failure mode for a clear-wood specimen subject to bending. Whereas Fig. 2.17(c) represents a phenomena called ‘grain inclination’. The wood grain is not horizontal, instead it is inclined at a shallow angle. In the presence of a tensile stress (induced through bending), the wood has broken in a direction perpendicular to the grain as a consequence of this inclination.

Anisotropy needs to be accounted for in structural design. Structures should be conceived to avoid circumstances that induce stresses perpendicular to the axis of the member (Fig. 2.18). Anisotropy of timber could be regarded as one of the material’s limitations, however, products such as cross-laminated timber (or CLT)



**Fig. 2.17.** Different failure modes: (a) compression parallel to grain, (b) bending failure, (c) bending failure in the presence of inclined grain.



**Fig. 2.18.** Cross-laminated timber consists of orthogonally glued laminations. It is a versatile product that can be used as a slab or a wall, as seen here.



and plywood resolve this limitation by creating panels with laminations of timber glued orthogonally.

Table 2.7 lists several strength and stiffness properties for softwood strength classes. Note the difference of magnitude between properties measured parallel to the grain and perpendicular to grain.

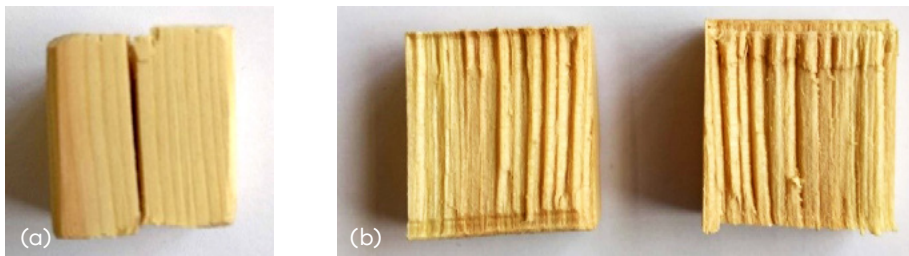
Table 2.7  
Strength and Stiffness Properties According to Strength Classes for Softwood Based on Edgewise Bending Tests (Adapted from EN 338:2016)

Strength class	Strength properties in N/mm <sup>2</sup>					Stiffness properties in kN/mm <sup>2</sup>		
	Bending ( $f_{m,k}$ )	Tension parallel ( $f_{t,0,k}$ )	Tension perpendicular ( $f_{t,90,k}$ )	Compression parallel ( $f_{c,0,k}$ )	Compression perpendicular ( $f_{c,90,k}$ )	Shear ( $f_{v,k}$ )	Mean modulus of elasticity parallel bending ( $E_{m,0,mean}$ )	Mean modulus of elasticity perpendicular ( $E_{m,90,mean}$ )
C14	14	7.2	0.4	16	2.0	3.0	7.0	0.23
C16	16	8.5	0.4	17	2.2	3.2	8.0	0.27
C18	18	10	0.4	18	2.2	3.4	9.0	0.30
C20	20	11.5	0.4	19	2.3	3.6	8.5	0.32
C22	22	13	0.4	20	2.4	3.8	10.0	0.33
C24	24	14.5	0.4	21	2.5	4.0	11.0	0.37
C27	27	16.5	0.4	22	2.5	4.0	11.5	0.38
C30	30	19	0.4	24	2.7	4.0	12.0	0.40
C35	35	22.5	0.4	25	2.7	4.0	13.0	0.43
C40	40	26	0.4	27	2.8	4.0	14.0	0.47
C45	45	30	0.4	29	2.9	4.0	15.0	0.50
C50	50	33.5	0.4	30	3.0	4.0	16.0	0.53

## 2.5.2. Brittleness and Ductility

---

Timber also exhibits another phenomena that should be observed. As is noticeable in Fig. 2.16, compressive failure of non-slender members tends to exhibit a ductile behaviour (i.e. the material can hold the maximum load whilst undergoing continued strain) regardless of direction of loading. Other failure modes in timber tend to be more brittle (i.e. the material rapidly loses load-bearing capacity after reaching the maximum load). As discussed, this is noticeable in bending when specimens are dry (Fig. 2.13). Tension failures, both parallel and perpendicular to the grain are brittle as well. Similarly, shear failures are very brittle - Fig. 2.19. Therefore, structural designers should avoid circumstances in which shear failures may be induced, as they will occur with little warning.



**Fig. 2.19.** Image of clear-wood specimen subject to shear: (a) side elevation, (b) view of failure plane.

## 2.6. DURABILITY OF TIMBER

In common with most bio-based materials, timber is destined to biodegrade. This means that there is a wide range of biological agents that have evolved to feed off timber. Obviously, throughout the existence of the building these biological agents need to be controlled and deterred. However, the fact that timber can be disposed of easily after fulfilling a useful role and reintegrated into the bio-sphere should be seen as an advantageous quality of timber. Most other construction materials, if not burnt, reused or recycled, will become waste causing a variety of environmental problems.

There are several factors that increase or reduce the durability of timber some of which are discussed hereafter. Firstly, the species. Some species, especially some tropical hardwoods are very durable, even when exposed to very harsh environments, for example in contact with the ground such as foundation piles or telephone poles. It should be noted that in most species heartwood is significantly more durable than the sapwood, in fact for most species sapwood should be avoided. As a rule, species that have high natural durability grow much slower. This makes their exploitation more expensive and less sustainable. An alternative is to impregnate the timber with a chemical preservative, which is the second factor to consider. There is a wide variety of chemical treatments, with variable complexity of application, toxicity and cost. The selected treatment should be closely matched to the location in which the timber will be used. These locations are referred to in EN 335-1 as Use Classes – refer to Table 2.8.

A careful inspection of Table 2.8 shows that the variety of possible biological agents that can attack timber increases as its location shifts from drier locations to wetter ones, especially if it comes in contact with the ground. Experience shows that the simplest and most effective way to increase the durability of timber is to avoid it becoming wet and to place it away from the ground through appropriate detailing (refer to the ‘Durability by design’ subsection below). This allows the designer / specifier to select either a less durable species – hence more economical – or a less intensive preservative treatment (or none at all), which will also be more economical.

Table 2.8

Use Classes for Timber and Biological Agents Present  
(Adapted from EN 335-1)

Use class	General service situation	Description of exposure to wetting in service	Biological agents
1	Interior, covered	Dry	Wood boring beetles
2	Interior or covered	Occasionally wet	
3	3.1 exterior, above ground, protected	Occasionally wet	As above + Disfiguring fungi + Decay fungi
	3.2 exterior, above ground, unprotected	Frequently wet	
4	4.1 exterior, in ground contact and / or fresh water	Predominantly or permanently wet	As above + Soft rot
	4.2 exterior in ground (severe) and / or fresh water	Permanently wet	
5	in salt water	Permanently wet	Decay fungi Soft rot Marine borers

Note: termites may be present in all use classes.

### 2.6.1. Durability by Design

If timber is used in an appropriately designed building, where it is kept away from wetting and the ground, it can last indefinitely. In fact, there are examples of timber buildings that are over 500 years old in many parts of the world (refer to Figs. 2.20 to 2.22). As discussed, timber that is maintained below a 20 % moisture content is inhospitable to the development of any fungus, and the only remaining biological agents that can attack it are wood boring beetles and termites, though beetles thrive in timber with a higher moisture content. Termites are known to attack dry wood, but they live underground and require tunnels to reach the wood. A careful design will force them to expose their tunnels and the infestation can be prevented by a routine inspection accompanied by the destruction of the tunnels.

Chemical preservatives can enhance the durability of timber by making it harder for insects to attack or fungi to grow, but chemical treatment cannot fully substitute appropriate design. It is the designers' responsibility to ensure that locations that could result in the trapping of moisture are avoided from the conception of the structure. Every source of moisture should be

considered and addressed, these sources include: rainfall, capillarity from the ground, condensation and water sources (e.g. bathrooms). Water should be shed rapidly, and water vapour allowed to move away through appropriate ventilation. It is the builder's responsibility to observe these details and specifications and question any poor detailing.



**Fig. 2.20.** Toji Buddhist Temple, Kyoto, Japan, dating from the 15<sup>th</sup> century.  
© David Trujillo.



**Fig. 2.21.** Rengeoin Sanjusangendo, Kyoto, Japan, dating from the 13<sup>th</sup> century.  
© David Trujillo.

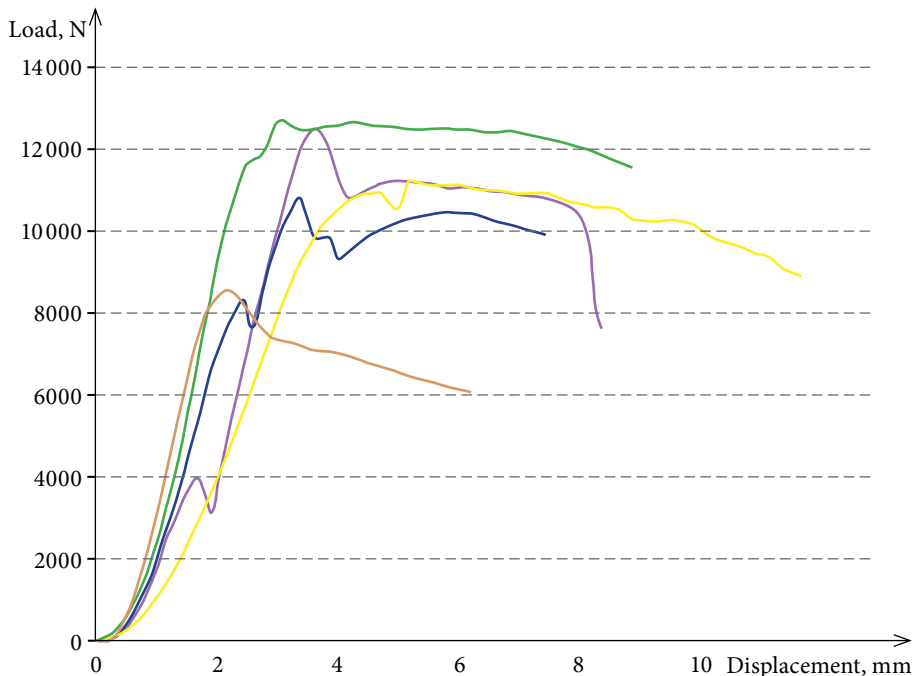


**Fig. 2.22.** Middleton Hall – parts of the hall date from the 13<sup>th</sup> century. © David Trujillo

## 2.7. VARIABILITY

In common with all natural materials, there is a diverse range of factors that affect the quality of the final ‘product’. No two trees are identical. There is a range of genetic and environmental reasons why they will differ. In fact, there is substantial variation in quality within a tree. The way the forest is managed and then the wood is sawn creates additional permutations. Natural ‘defects’, such as knots, create irregularities in the wood grain, that introduce further variability to the material’s performance. For all the aforementioned reasons, there is a great deal of variability within timber. For instance, Fig. 2.23 shows the load-deformation graph for five identically sized clear-wood (i.e. free from knots) softwood specimens. The strength and behaviour are significantly different and apparently quite unpredictable.

The large variability of timber creates a great deal of uncertainty about its structural performance. One way in which this uncertainty can be addressed is to assume in design that the element will be weaker than most of the

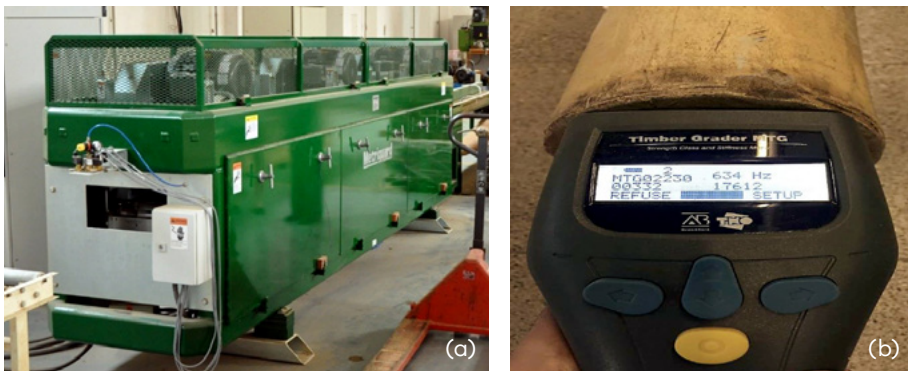


**Fig. 2.23.** Load-deformation graph for five clear wood specimens subject to compression parallel to grain.

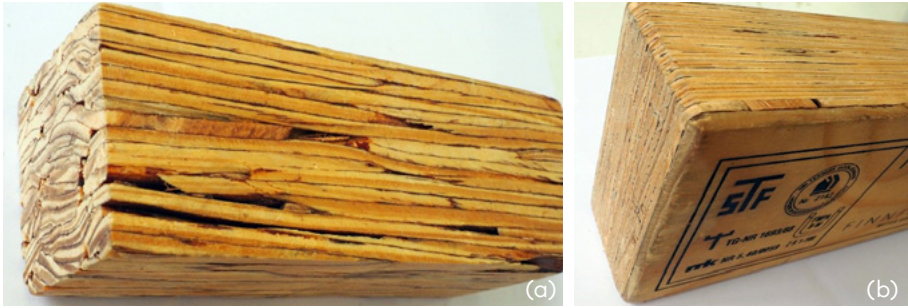


population of results. In the Eurocodes (and their harmonised EN standards), we use the concept of characteristic values. For strength and density, a characteristic value is the fifth percentile with a 75 % confidence. This means that if we tested 100 specimens, we would expect that 95 of them would be stronger than what we have assumed in design. This ensures structures remain safe.

However, some defects, such as knots, can significantly debilitate timber, and it makes more economical sense to limit their presence than to assume an excessively low strength in design. Therefore, producers try to exclude and/or control the presence of these strength-reducing defects. There are different ways they can control defects. One of these is to subject the timber to a process called ‘strength grading’. This process can be undertaken by a trained person through a process called ‘visual grading’, by which they will reject specimens that contain too many defects. Alternatively, a machine can be used to infer the strength of timber by measuring non-destructively measurable properties in a process called ‘machine grading’. Figure 2.24 shows two types of grading machines. An alternative way to obtain a less variable property is to combine laminations, veneers or strands of timber into what are known as ‘engineered timber products’ – refer to Figs. 2.25 and 2.26.



**Fig. 2.24.** Two types of grading machines: (a) Metriguard lumber grader, (b) Brookhuis handheld Timber Grader.



**Fig. 2.25.** Two types of engineered timber products: (a) Parallel Strand Lumber – PSL, and (b) Laminated Veneer Lumber – LVL.



**Fig. 2.26.** Glued laminated timber, or glulam, is another engineered timber that can adopt varied shapes (a) and achieve very impressive sizes (b): (a) Scottish Parliament, (b) GlaxoSmithKline Carbon Neutral Laboratory for Sustainable Chemistry, University of Nottingham.

## 2.8. BEHAVIOUR IN FIRE

Timber is a combustible material which affects its perception as a structural material. Obviously, combustibility is a hazard that needs to be controlled by both the building designer and constructor. The perceived risk presented is deeply engrained in popular culture. However, its combustibility offers the possibility that at the end of its useful life it can be burnt for energy generation, hence offering one final service.

As timber burns it develops an external layer called 'char'. The rate at which the char develops, known as 'charring rate', is slow and predictable. Char has very good insulating properties which maintain the unburned timber cool and unaltered. The consequence of this is that timber only loses resistance as a result of loss of cross-sectional area. Charring rates are contained in design codes (Table 2.9) and are used to calculate the fire resistance of a member through quite a simple process.

Table 2.9  
Design Charring Rates for Timber and Some Wood-based Products  
(Adapted from EN 1995-1-2:2004)

Type of timber or wood-based product	Charring rate	
	$\beta_o$ for one-dimen- sional charring mm/min	$\beta_n$ notional mm/min
Softwood and beech		
Glulam with a characteristic density of $\geq 290 \text{ kg/m}^3$	0.65	0.7
Solid timber with a characteristic density of $\geq 290 \text{ kg/m}^3$	0.65	0.8
Hardwood		
Solid or glulam hardwood with a characteristic density of $\geq 290 \text{ kg/m}^3$	0.65	0.7
Solid or glulam hardwood with a characteristic density of $\geq 450 \text{ kg/m}^3$	0.50	0.55
LVL		
With a characteristic density of $\geq 480 \text{ kg/m}^3$	0.65	0.7
Panels*		
Wood panelling	0.9	–
Plywood	1.0	–
Wood-based panels other than plywood	0.9	–

\*with a characteristic density of  $\geq 450 \text{ kg/m}^3$  and thickness  $\geq 20 \text{ mm}$

The rate of burning is proportional to the exposed surface area, therefore, a large timber element will take longer to burn than numerous smaller pieces, even if they constitute overall the same volume. Charring rates are also species specific, as they are affected by density. Denser timber burns slower.

### 2.8.1. Reaction to Fire

Reaction to fire refers to the behaviour of a material when exposed to fire; it reflects how easily it ‘catches fire’, and then what contribution it will make to the fire and its spread. Materials are tested and then classified accordingly. EN 13501-1:2018 sets the classes outlined in Table 2.10, where timber would be classified as *D*. Wood-based panel products (e.g. plywood and OSB) tend to be classified as *D* or *E*. Through the use of fire-retardant products, timber’s performance can be improved up to class *B*. Nevertheless, timber is difficult to set alight. In the absence of a naked flame, temperatures typically have to exceed 400 °C for ignition to occur.

Table 2.10  
Reaction to Fire Classes for Construction Materials According  
to EN 13501-1:2018

Class	Smoke classification	Burning droplets / particles classification
A1	Not applicable	Not applicable
A2	Test for smoke production classes:	Test for burning droplets / particles:
B	s1, s2 and s3	d0, d1, d2
C		
D		
E	Not applicable	
F		Not applicable

## 2.8.2. Fire Resistance

---

Fire resistance refers to the ability of a building item, or element, to fulfil specific requirements during a fire test for a given amount of time. The specific requirements are: 1) the building item or element must not collapse, 2) it must not allow fire to penetrate, and 3) it must offer adequate resistance to transfer of heat. The three criteria are sometimes referred to as ‘stability, integrity and insulation’, respectively. Fire resistance is not a property of a material but of a building system, as such, different materials may be combined to obtain a targeted resistance. Building codes and regulations across the world typically state the required fire-resistance in minutes and the test used to determine the resistance.

## 2.8.3. Improving Performance

---

The fire performance of timber can be improved by the adoption of any, or a combination of the following passive strategies.

1. Oversizing of members. As discussed, the charring process provides good fire-protection to the internal unburnt section, and loss of strength occurs only as a consequence of cross-sectional area. Therefore, the designer can oversize a section to ensure a given member will not fail during a fire of a specified duration. The process fundamentally consists in multiplying the values from Table 2.9 by the required time of fire exposure. The member is then increased in every exposed dimension by whatever dimension was obtained.
2. Encapsulating in a board product. Some board products – such as plasterboard – have very good fire performance, thus performance is improved by enclosing the timber members within a board product.
3. Modification to reaction to fire. As discussed, fire-retardant coating products may be used to slow down ignition and spread of flame.

It is important to observe that some strategies are implemented during the latter stages of a construction project, for example, plasterboard may not be fixed until the structure is finished. Therefore, timber buildings may be particularly vulnerable to fire during construction.

## 2.8.4. Further Points

---

As stated previously, timber is combustible; therefore, once it ignites, the timber structure starts contributing to the fire-load, in this respect it is unlike most other conventional *structural* materials<sup>1</sup>. Nevertheless, non-combustibility does not guarantee good fire performance. For example, steel and aluminium rapidly lose strength and stiffness during a fire, and due to their high thermal conductivity, the effects propagate rapidly. Figure 2.28 shows a detail in which a steel connector has been concealed by timber. This is because timber offers the steel some fire protection. If the steel connector were exposed directly to the fire it could rapidly lose its strength or burn the wood in its proximity.



**Fig. 2.28.** Due to its better fire performance, timber conceals the steel beam-to-column connection – GlaxoSmithKline Carbon Neutral Laboratory for Sustainable Chemistry, University of Nottingham. © David Trujillo.

---

<sup>1</sup> It should also be noted that there are numerous other construction materials that are combustible, these are either bio-based (e.g. bamboo) or polymer-based, such as PVC, Polyurethane, Polystyrene and Fibre Reinforced Polymers. These materials are either non-structural or non-conventional construction materials.

## REFERENCES

---

C40 cities, Arup and University of Leeds. (2019). *The future of urban consumption in a 1.5 °C world* (Headline Report). C40 cities.

Churkina, G., Organschi, A., Reyer, C. P. O., Ruff, A., Vinke, K., Liu, Z., Reck, B. K., Graedel, T. E., & Schellnhuber, H. J. (2020). Buildings as a global carbon sink. *Nature Sustainability*, 3, 269–276. <https://doi.org/10.1038/s41893-019-0462-4>

Masson-Delmotte, V., Zhai, P., Pörtner, H.-O., Roberts, D., Skea, J., & Shukla, P. R. (2018). *Global warming of 1.5 °C: An IPCC special report on the impacts of global warming of 1.5° C above pre-industrial levels and related global greenhouse gas emission pathways, in the context of strengthening the global response*. IPCC.

TRADA. (2015). *Wood information sheet WIS 2/3-10: Timbers – their properties and uses*. High Wycombe: BMTrada.

United Nations. (2018). *World urbanization prospects: The 2018 Revision*. United Nations Department of Economic and Social Affairs.

*EN 338:2016 Structural timber – Strength classes*. CEN.

*EN 335-1 Durability of wood and wood-based products – Definition of use classes – Part 1: General*. CEN.

*EN 1995-1-2:2004 Eurocode 5: Design of timber structures – Part 1-2: General – Structural fire design*. CEN.

*EN 13501-1:2018 Fire classification of construction products and building elements. Classification using data from reaction to fire tests*. CEN.





# Chapter 3

## Design of Sustainable Public Buildings

### 3.1. Building Design by BIM

*Peter Ebbesen*

### 3.2. Load Bearing Structures

*Tomas Gecys*

### 3.3. Moisture Performance

*Anssi Knuutila*

### 3.4. Fire Safety

*Taneli Rasmus*

### 3.5. Acoustics and noise-abatements

*Carl Mills*

### 3.6. Design of Building Service System

*Ole Thorkilsen*

### References



## 3.1. BUILDING DESIGN BY BIM

---

**Peter Ebbesen,**

VIA University College

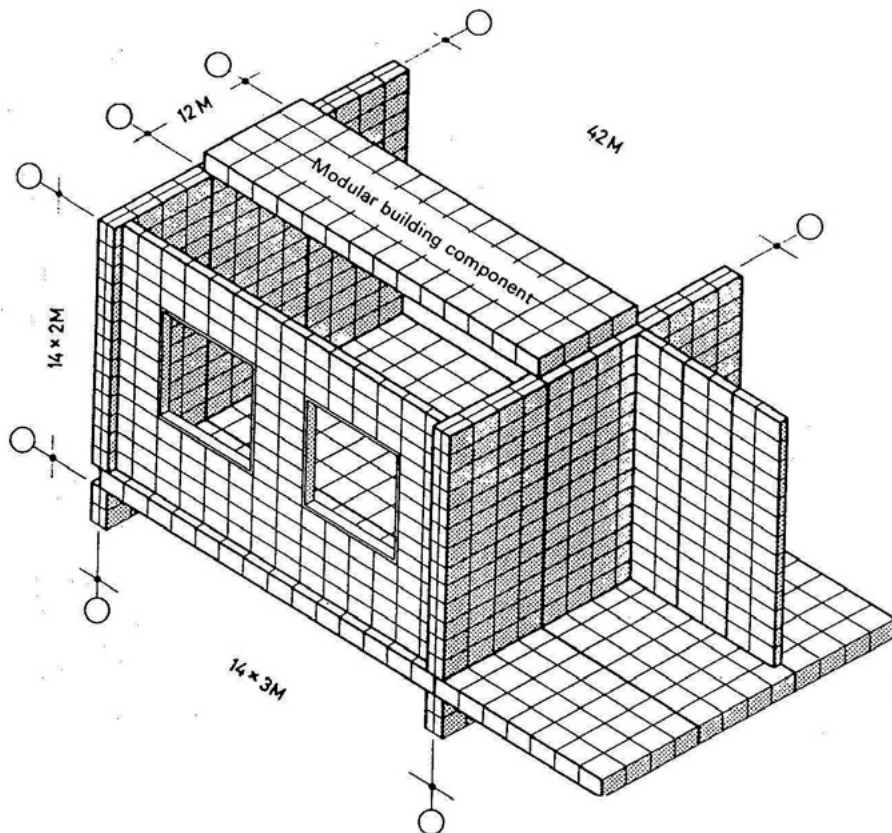
BIM is an acronym for Building Information Modeling, a certain method of working and collaborating digitally in a building project. The word ‘model’ refers to the fact that designing with BIM is always 3D modelling. Using BIM methods in a building project requires using digital object-oriented parametric tools that support BIM. Autodesk Revit® (2020) is one such parametric BIM-supporting tool among many advanced CAD-programmes. For ease of reference, all instructions in this book will refer to Revit.

### 3.1.1. Industrialised Building, Modular Design and Transport

---

One of the main advantages of building with timber elements is that it is possible to complete the building carcass relatively fast. While mass timber structures are often built as components off site and assembled at the project site, light frame construction typically occurs entirely on site. Increasingly, however, elements of light frame buildings are fabricated off site and assembled on the job. Off-site construction offers greater control over construction conditions and improved safety oversight for all material types while requiring less skilled labour on site and contributing to faster construction timelines. If we want to build public buildings fast, economical and safe, we need to apply a modular design. An industrialised building system (IBS) may be defined as one in which all building components such as walls, floor slabs, beams, columns and staircases are mass produced either in factory or off site under strict quality control and minimal on-site activities (Thanoon et al., 2013; Trikha, 1999). The objectives of modular co-ordination are to create the basis upon which the variety of types and sizes of building components can be minimized, and secure that all elements fit together without cutting or extending even when different suppliers manufacture the components and fittings.

The modular system using 100 mm as a basic module 'M', has been made international in order to facilitate trade in building materials, etc. (Thanoon et al., 2013). The unit is sufficiently small to satisfy most requirements regarding intervals on normal building components. The basic module may also be a unit which is 'too small' to achieve the desired simplification and limitations of variants. This applies particularly to large building components, such as floor and wall elements in the structural framework, and the so-called planning modules have therefore been introduced for use in the planning modules which are multiples of the basic module. Planning modules are mainly used in the design of the carcass, i.e. all structural and shielding parts of the building are planned by means of these dimensions, while the basic module is used in the design of the interior (Fig. 3.1).



**Fig. 3.1.** All building components in this model are correctly located in their modular zones within the modular space grid. However, technical detailing of the connections usually leads to the grid being broken in several places (Nissen, 1972).

Planning module 3M or 6M is the common horizontal dimension used in most European countries, including Scandinavia. Within the ISO, many countries use 2M or 3M for the vertical planning module.

In order to use the maximum possible number of uniform types of components in dwelling houses and other types of building, these works should be designed on the basis of planning modules, which are multiples of 3M unless heavy functional considerations call for other dimensions. The establishment of larger planning modules, for use in industrial and public buildings, can make use of 'Industriebaumass' (Neufert, 2018) IBA = 2500 mm or IBA/2 = 1250 mm, or other preferred multimodules, e.g. 12M horizontal and 6M vertical.

The choice of preferred multimodules is not, of course, just a question of production methods and money. Preferred multimodules have a direct influence on room dimensions, spans, etc., and they must therefore be determined on the basis of the functional requirements of the project.

As an example of preferred multimodules taken from practice, we can look at modular concrete floor slabs, which use controlling dimensions of 12, 18 or 24M (cross-section) and lengths ranging from 18M to 54M. Vertical dimensions for normal storeys of apartment houses controlled by the planning module 2M have a fixed storey height of 28M. The floor slab, which is the structural part of the horizontal division, is placed one joint proportion (5 mm) under the modular plane (Fig. 3.1).

In general, preferred multimodules must be selected to suit the function, construction and material of the components with a view to achieving an economical production. Solid wood panels are considerably lighter than concrete elements, so we will be able to design larger components without taking into consideration the lifting capability of lorries or cranes. Bear in mind that the limits of transportation, rather than physical handling of the component, often will define the maximum size of the component. It is not uncommon that timber elements are produced quite far away, maybe even in another country.

In Denmark, a special transport permit must be issued if the total dimensions of freight transport by lorry exceed a width of 3.30 m, a height of 4.10 m and a length of 22.0 m. Total height is here typically limited by freeway bridges. According to European best practice guidelines for abnormal road transports and Directive 96/53/EC, no permit is needed for road transport with a maximum overall height of 4 metres (European Parliament & Council of the European Union, 2008). The objective of these best practice guidelines

is to contribute to the development of European environment in which cross-border abnormal road transports can take place with a minimum of hassle, ideally in an uninterrupted way.

### 3.1.2. Modular Grid, Tolerances and Placing of Components

---

Once the module, the planning module and the preferred multimodule have been decided, and possibly standardised, two further roads are open for development of the modular system:

A. Design over a modular grid.

B. Design with modular components.

In case A, the project is drafted over a modular grid, and both principal and detail dimensions are fitted to the grid. This approach would be fine if our main structural elements are joists and beams made of engineered timber, which replace steel in many building projects. In case B, the individual components are first defined, e.g. whole wall timber elements or box modules, and later the modular grid is designed to accommodate these modular components.

The area between modular lines is called the modular zone. A modular component must normally be kept within its modular grid, but technical considerations may require certain connections which might entail the components exceeding their modular zones, e.g. tongue and groove, bolted connections and similar. When we have simple, uniform, modular components in a row, there is no conflict with modular grid, and we can design both with a grid and with modular components. However, as soon as we have to design other connections, e.g. corners or T-junctions, problems arise in which either the grid must give way or special, frequently non-modular, components must be made (Nissen, 1972).

The planning module grid is used mainly for the design of the carcass, though it also serves as a way of navigating the project, setting out, and controlling the mounting process. During the design work, the building components are placed in relation to each other using the planning module grid as means of coordination.

Structural exterior walls are normally placed in the modular grid with their

edges along the modular lines.

Structural interior walls are placed with their centre planes along the modular line, unless the technical considerations call for a different placing.

Floor components are placed within their modular zones.

Separated modular grids may occur as a result of special technical conditions.

For accomplishing the requirement of modular coordination, all components need to be standardised for production. Such standardisation of space and elements needs prescribing tolerances at different construction stages such as manufactured tolerances, setting out tolerances and erection tolerances, so that the combined tolerance obtained on statistical considerations is within the permitted limits (Triakha, 1999). Wall elements in a row will be separated with joints where they are divided with a grid line. If the modular grid is the horizontal controlling dimension, e.g. 24M, then the wall elements will have a basic dimension of  $24M - 2 \times (\frac{1}{2} \text{ joints})$ . The joint dimension here is governed by the sum of manufactured tolerances  $f_{\max} - f_{\min}$ , erection tolerances  $T_{\max} - T_{\min}$  and the joint (total) between elements for climate tolerances. Wall elements that do not comply with modular dimensions, and in terms of size are not within the agreed tolerances, must be rejected.

Timber elements, e.g. CLT panels are cut to size, including door and window openings, with state-of-the art computer numerical controlled (CNC) routers, capable of making complex cuts with low tolerances. Normal tolerance is down to  $\pm 3$  mm, but you also have to consider deformation due to climate change like relative air humidity and temperature. Especially if the finished surfaces of the panels are visible and not covered with fire protection plasterboard.

### 3.1.3. Collaborate with Discipline Models, Project Parameters

---

Every 3D modelling BIM-software has the ability to insert grid lines in a plan view (the grid does not belong to a particular view) and levels for vertical control, and the opportunity to customize grid heads. The modular grid can be placed manually or with an offset. We add Aligned Dimensions afterwards in, e.g. Revit. Lock (Pin) the grid to avoid any unwanted editing (Fig. 3.2).

When the modular planning grid is all set up, we just draw corresponding

architectural wall type components as continued (chain) walls and put in the openings for doors and windows and so forth. That is essentially all the architect will do at this point. Depending on what system we are using for tender, it is now up to the structural engineer, or the manufacturer, to divide the walls into the individual wall elements.

First, we start up a new project file and then we Link the architect's 3D building model to our project, so we are able to use the architect's walls and modular grid as an underlying drawing. We might want to link the structural engineer's model as well. In Revit, this is also the advantage that we can see if the architect or engineer has moved any walls, openings or even gridlines, when we periodically update the linked model. At this point, it is clearly a bad idea to alter the grid at all, unless the structural engineer or the manufacturer are demanding a change. Now we could just copy the design by manually drawing the exact same components in our timber element project and use a split with gap tool to divide the walls. However, in Revit there is a smarter way of doing this to minimize the risk of an input error from our team. A Collaborate function monitors and coordinates changes to elements between our host project and linked model. When other teams move or change a monitored element, our team is notified so that we can adapt their designs or resolve issues. At this point, use the Copy/Monitor tool to transfer the modular grid only.

In Revit the individual walls are transferred in a different way, and an advantage of this method is that the walls geometry is automatically updated

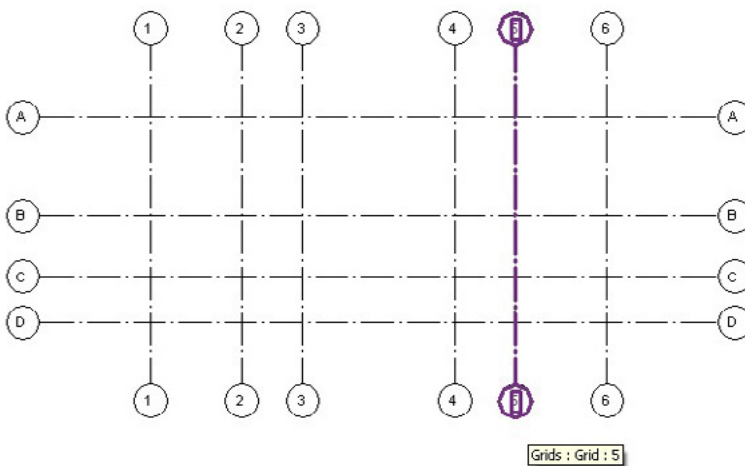


Fig. 3.2. Basic grids in Revit.



when we reload the linked models. We use Create Parts from the Modify menu to get geometry of relevant walls. In the case of generic elements, a single part element is created. For other elements with layers or subcomponents, such as walls, individual parts will be created. The geometry is automatically updated to reflect any changes to the element from which they are derived. Modifying a part has no effect on the original element. Note that the project parameters and shared parameters and level data propagate to parts.

Parts Visibility specifies whether parts and the elements they were created from will display in a particular view. In a floor plan view, choose Show Parts in view properties. We can now start dividing our walls into individual solid wood panels. Again, Revit has a handy tool that will speed up the process. With Divide Parts, we can sketch geometry to divide the parts, or we can divide them with one or more intersecting references, such as levels or grids. We can handle non-modular wall elements by unselecting the dividing reference (gridline) or manually divide or merge the remaining non-modular parts. In the Divisions Geometry Properties panel, we specify the amount of gap we want between all our individual elements, or just set an Offset when you select the grids. Gap or joint dimensions can be specified by the manufacturer, assessed in relation to special technical conditions, and reduced or extended demands to tolerances.

Although wood panel products are often made from gluing layers of solid-sawn lumber together, they are represented as one solid in our 3D model. Still there are some advantages in Revit when we define individual wall parts as an Assembly. The Assemblies category of Revit elements supports construction workflows by letting you identify, classify, quantify, and document unique element combinations in the model. Each unique assembly is listed as a type in the Project Browser. We can select an assembly type in the Project Browser or an instance of that type in the drawing area and generate one or more types of isolated views of the assembly as well as parts lists, material take-offs, and sheets. Assembly views are listed in the Project Browser, from where they can be easily dragged onto the project or assembly sheet views as needed. For now, we only make use of the Assemblies ability to keep track of how many types of panels we are generating. Use the Assembly Name 'TYPE' and all following creations are automatically named the same followed by a type number identifier. Depending on the specific project, we might want to create one code for exterior walls and another for partition walls and floors and so forth.

We need to organize all the different assemblies / elements we created by adding more parameters and show this information in Tags. There is a

difference between instance and type parameter. Instance Parameters enables us to modify the parameter value separately for every instance or element. Type Parameters will modify the parameter value, which applies to all elements of the same family type. In Revit we can annotate each wall part with Tag by Category. By default, Tags will display the Assembly Name and Mark parameter (if not empty). In Properties for the selected assembly, we could add a part number in the Identity Data / Mark wall-part, space, eight (WP\_8) assuming there are eight instances of the type. However, it is better to edit the Tag so it displays the prefix 'WP\_' so we only put 8 in the Properties field. Continue to add Instance Parameters and unique identifiers for duplicates to all parts / assemblies.

### 3.1.4. Number Plan with Element List, Production Drawings

If we were the manufacturer of solid wood panels, it would also be handy to display some information about logistics, like production or delivery batch number / dates or truck number. A maximum of 40 m<sup>3</sup> or 20 t of CLT panels can be transported horizontally per truckload, depending on the articulated lorry (Stora Enso, 2012).

In all BIM-software we are able to add a user-defined field for Project Parameters. Note that in Revit we have to use Shared Parameter if we want to display the data in both schedules and tags. These user-defined fields are stored separately in a Shared Parameter File (.txt), which can be reused in other projects. In the txt-file we can add a new Group called 'Logistics' and define a field named 'Truck Number' (Fig. 3.3). Hereafter, we are able to add our field to Project Properties. We organize it under Identity Data and set it to be an Instance for individual elements and specify that the field will appear in the category for Assemblies only. Now we can edit our wall assemblies' tags to display the Shared Parameter Truck Number below

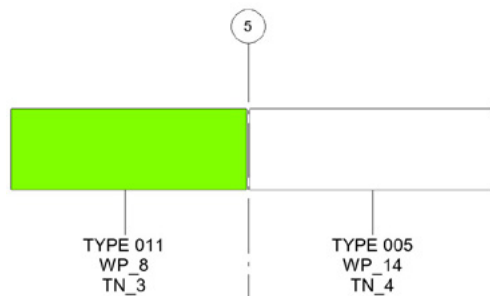


Fig. 3.3. Example of Tag with a panel type and wall part identifier and truck number.

our optional Mark wall part identifier and add this information to all of our elements. Again, edit the assembly tag to display the 'TN\_' as a prefix with a line break. Note that we can also use tags on the elevation views of assemblies we generate to show dimensions of recess / rebates and holes.

To enhance the visual display of information further, we can add some filters to the view that represents our floor plan drawing. Visibility / Graphics overrides can specify whether elements and categories are visible in the view and their graphical appearance (colour, lineweight, and linestyle). What we want to do is define a new Rule-based Filter and name it 'TN\_3'. This filter should apply to the Parts Categories, and the Filter Rule trigger is the Shared Parameter Truck Number; equals; 3. Now we can add the 'TN\_3' Filter to our floor plan view, set the Cut Pattern Override to Solid fill, and change the colour to, e.g. green. Hereafter, we just duplicate the Filter we just created and make appropriate adjustments like changing the colour.

If we want to make a Number plan with element list, we still need to add some Schedules to our drawing. In Revit we create a Part Schedule and select the relevant fields with detailed information from the Parts Category (Assembly Name <type>; Count <total of each type>; Height; Thickness; Length; Area; Weight <calculated parameter>). It is even possible to retrieve the original Type and Category from the linked file. We also need logistic information from an Assembly Schedule (Type <combined with> Mark; Count; Truck Number). Schedules are filtered and formatted much in the same way as MS Excel (Fig. 3.4).

We only need to drag our floor plan view and the schedules on to a sheet and we have finished the Number plan with element list. We can continue to work smarter and add more Type parameters like 'cost' for estimation of bid price or tender cost of production. Because it is BIM, all data on sheets (drawings) are updated automatically if we make any project alterations.

Assembly Schedule			
Type/Part Mark/	Count	Mark	Truck Number
TYPE 011 / Part 8	1	8	3
TYPE 002	1		5
TYPE 007 / Part 1	1	1	5
TYPE 007 / Part 2	1	2	7

Fig. 3.4. Example of schedule with logistic information. Column 1 consists of merged data, making the 'Mark' column redundant.

### 3.1.5. Planning for Mounting, Operational Drawings

---

The previous described techniques can also be used to create the Planning for mounting. The key logistic information regarding the mounting are panel dimensions and positioning according to grids and precise timing of the mounting process. We can reuse the overall layout from the Number plan but change graphics overrides to display the same colour for all elements, which are to be mounted on day 1, and another colour for day 2 and so forth. We need to create a schedule with precise information for each of the working days. The schedule must display the amount and type of panels that arrive, the truck number, and the arrival time. Create a filter to match the background colour of schedules with the colour of corresponding wood panels.

The wall elements must be transferred using the lifting gear provided on site or by the contractor. Care must be taken to ensure that the crane system is adequately stable during the construction phase. Although the solid wood panels are not that heavy, CLT weighs approx.  $470 \text{ kg/m}^3$ , they are quite sensitive to strong winds. The geometry and shape of the load play a great role in what is known as the 'sail area' effect. If we are lifting a large flat sheet, it can catch the wind like a sail. This can cause the load to be pushed out of plum resulting in adverse effects on the crane. When lifting in wind, the rule of thumb for manageable sail effect is  $1 \text{ m}^2 = 1 \text{ tonnes}$ . Therefore, the area and weight of the wood panel need to be listed in such a way that the crane operator easily can calculate the maximum wind speed allowed during lifting operations that would result in the piece staying plum on the crane.

We hope that we have pointed out the key principles and performance benefits of designing wooden public buildings in a modular system. We hope we have demonstrated how to use basic BIM and parameters to work smarter. We showed ways to collaborate with discipline models and ways to monitor and coordinate changes to elements between our host projects. We pointed out the differences between Type, Instance, Project, (user defined) Shared Parameters. We showed how to create schedules that can reflect parameters. We demonstrated that it is possible to use parameters to apply filters and graphical overrides to components and schedules. We described the applications of Number plan with element list, and Planning for mounting. We transmitted knowledge about restrictions regarding transport and lifting of mass timber structures.

The key word examples for some of the conditions, which should be reflected in the schedules are:

- type and part identifiers;
- basic dimensions of relevance;
- truck number, information regarding delivery process;
- area (sail) vs. weight information for lifting;
- mounting sequence of elements.

## 3.2. LOAD BEARING STRUCTURES

**Tomas Gecys,**

Department of Steel and Composite Structures, Vilnius Gediminas  
Technical University

### 3.2.1. General Data

In most European countries European design codes are being used for the structural design of load bearing structures. Eurocode 5 is used for the structural design of timber structures. Further in this chapter the main principles of structural timber design will be presented.

Timber as a material is sensitive to relative humidity of the surrounding air. These conditions are evaluated by assigning structures to the service classes. The service class system is mainly aimed at assigning strength values and for calculating deformations under defined environmental conditions.

There are 3 service classes according to EN 1995-1-1:

- *Service class 1* is characterized by a moisture content in the materials corresponding to a temperature of 20 °C and the relative humidity of the surrounding air only exceeding 65 % for a few weeks per year. In Service class 1 the average moisture content in most softwood will not exceed 12 %.
- *Service class 2* is characterized by a moisture content in the materials corresponding to a temperature of 20 °C and the relative humidity of the surrounding air only exceeding 85 % for a few weeks per year. In Service class 1 the average moisture content in most softwood will not exceed 20 %.
- *Service class 3* is characterized by climatic conditions leading to higher moisture contents than in Service class 2.

The design value of strength property is calculated according to Equation 3.1:

$$f_d = k_{\text{mod}} \frac{f_k}{\gamma_M}, \quad (3.1)$$

where  $f_k$  is the characteristic value of a strength property, which is determined according to EN standards for the relevant material;  $\gamma_M$  is the partial factor for

a material property according to Table 3.1; and  $k_{\text{mod}}$  is a modification factor, taking into account the effect of the duration of load and moisture content, according to Table 3.2.

The recommended values of partial safety factors for timber-based products, for material properties and resistances according to EN 1995-1-1 are provided in Table 3.1.

Table 3.1

Partial Factors for Material Properties and Resistances  
According to EN 1995-1-1

Fundamental combinations:	$\gamma_M$
Solid timber	1.3
Glued laminated timber Glulam	1.25
LVL, plywood, OSB	1.2
Particleboards	1.3
Fibreboards, hard	1.3
Fibreboards, medium	1.3
Fibreboards, MDF	1.3
Fibreboards, soft	1.3
Connections	1.3
Punched metal plate fasteners	1.25
Accidental combinations	1.0

Some of the main modification factors of timber-based products, taking into account the effect of the duration of load and moisture content, according to EN 1995-1-1 are provided in Table 3.2. The examples of assignment of structures to the service classes are provided in National Annexes of each country. The effect of member size on tension or bending strength may be taken into account by height coefficient  $k_h$ .

For rectangular solid timber with a characteristic timber density less or equal to  $700 \text{ kg/m}^3$ , the reference depth in bending or width (maximum cross-sectional dimension) in tension is 150 mm. For depths in bending or widths in tension of solid timber less than 150 mm the characteristic values for  $f_{m,k}$  and  $f_{t,0,k}$  may be increased by factor  $k_h$  according to EN 1995-1-1 (Equation 3.2):

$$k_h = \min \left\{ \left( \frac{150}{h} \right)^{0.2}, 1.3 \right\}, \quad (3.2)$$

where  $h$  is the depth for bending members or width for tension members, in mm.



For rectangular glued laminated timber, the reference depth in bending or width in tension is 600 mm. For depths in bending or widths in tension of glued laminated timber less than 600 mm the characteristic values for  $f_{m,k}$  and  $f_{t,0,k}$  may be increased by factor  $k_h$  according to EN 1995-1-1 (Equation 3.3):

$$k_h = \min \left\{ \left( \frac{600}{h} \right)^{0.1}, 1.1 \right\}, \quad (3.3)$$

Table 3.2

Modification Coefficient Values of Main Timber-based Products According to Eurocode 5 (EN 1995-1-1:2004 + AC:2006 + A1:2008)

Solid timber	Standard	Service class	Load-duration class				
			Permanent action	Long term action	Medium term action	Short term action	Instantaneous action
Solid timber	EN 14081-1:2016+A1:2019	1	0.60	0.70	0.80	0.90	1.10
		2	0.60	0.70	0.80	0.90	1.10
		3	0.50	0.55	0.65	0.70	0.90
Glued laminated timber	EN 14080:2013	1	0.60	0.70	0.80	0.90	1.10
		2	0.60	0.70	0.80	0.90	1.10
		3	0.50	0.55	0.65	0.70	0.90
LVL	EN 14374:2004 EN 14279:2004+A1:2009	1	0.60	0.70	0.80	0.90	1.10
		2	0.60	0.70	0.80	0.90	1.10
		3	0.50	0.55	0.65	0.70	0.90
Plywood	EN 636:2012+A1:2015	1	0.60	0.70	0.80	0.90	1.10
		2	0.60	0.70	0.80	0.90	1.10
		3	0.50	0.55	0.65	0.70	0.90
OSB	EN 300:2006 OSB/2 OSB/3, OSB/4 OSB/3, OSB/4	1	0.30	0.45	0.65	0.85	1.10
		1	0.40	0.50	0.70	0.90	1.10
		2	0.30	0.40	0.55	0.70	0.90

### 3.2.2. Ultimate Limit States

Elements subjected to the tension force parallel to the grain should satisfy the following condition according to EN 1995-1-1:

$$\sigma_{t,0,d} \leq f_{t,0,d}, \quad (3.4)$$

where  $\sigma_{t,0,d}$  is the design tensile stress along the grain; and  $f_{t,0,d}$  is the design tensile strength along the grain.

Elements subjected to the compression force parallel to the grain should satisfy the following condition according to EN 1995-1-1:

$$\sigma_{c,0,d} \leq f_{c,0,d}, \quad (3.5)$$

where  $\sigma_{c,0,d}$  is the design compressive stress along the grain; and  $f_{c,0,d}$  is the design compressive strength along the grain.

Further in the chapter stability calculations are provided.

Elements subjected to the compression force perpendicular to the grain should satisfy the following condition according to EN 1995-1-1:

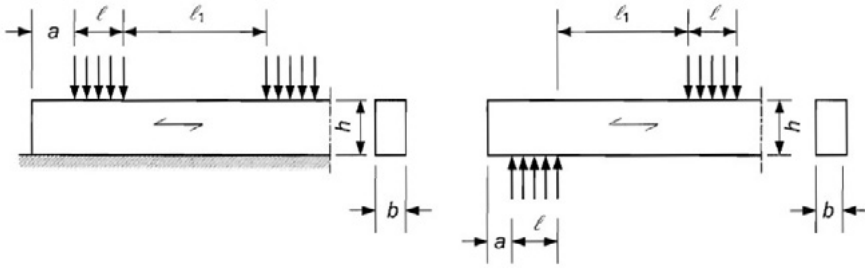
$$\sigma_{c,90,d} \leq k_{c,90} \cdot f_{c,90,d}, \quad (3.6)$$

$$\sigma_{c,90,d} = \frac{F_{c,90,d}}{A_{ef}}, \quad (3.7)$$

where  $\sigma_{c,90,d}$  is the design compressive stress in the effective contact area perpendicular to the grain;  $F_{c,90,d}$  is the design compressive load perpendicular to the grain;  $A_{ef}$  is the effective contact area in compression perpendicular to the grain;  $f_{c,90,d}$  is the design compressive strength perpendicular to the grain; and  $k_{c,90}$  is a factor taking into account the load configuration, the possibility of splitting and the degree of compressive deformation.

The effective contact area perpendicular to grain  $A_{ef}$  should be determined taking into account an effective contact length perpendicular to the grain, where the actual contact length at each side is increased by 30 mm, but not more than  $a$ ,  $l$  or  $l_1/2$ , as shown in Fig. 3.5.

The value of  $k_{c,90}$  may increase the compressive strength perpendicular to the grain, which evaluates the stress redistribution in the higher area than the actual. The limiting value of  $k_{c,90}$  is equal to 1.75.



**Fig. 3.5.** Application of loading perpendicular to the grain (EN 1995-1-1).

For members on continuous supports, provided that  $l_1 \geq 2h$ , see Fig. 3.5 (left), the value of  $k_{c,90}$  should be taken equal to:

- 1.25 for solid softwood timber;
- 1.50 for glued laminated softwood timber.

For members on discrete supports, provided that  $l_1 \geq 2h$ , see Fig. 3.5 (right), the value of  $k_{c,90}$  should be taken equal to:

- 1.50 for solid softwood timber;
- 1.75 for glued laminated softwood timber provided that  $l \leq 400$  mm,

where  $h$  is the depth of the member and  $l$  is the contact length.

Elements subjected to bending should satisfy the following conditions according to EN 1995-1-1:

$$\frac{\sigma_{m,y,d}}{f_{m,y,d}} + k_m \frac{\sigma_{m,y,d}}{f_{m,y,d}} \leq 1,0, \quad (3.8)$$

$$k_m \frac{\sigma_{m,y,d}}{f_{m,y,d}} + \frac{\sigma_{m,y,d}}{f_{m,y,d}} \leq 1,0, \quad (3.9)$$

where  $\sigma_{m,y,d}$  and  $\sigma_{m,z,d}$  are the design bending stresses about the principal axes;  $f_{m,y,d}$  and  $f_{m,z,d}$  are the corresponding design bending strengths.

Factor  $k_m$  evaluates the stress re-distribution, which depends on the shape of cross section. For solid timber, glued laminated timber and LVL it is:

- for rectangular cross-sections equal to 0.7;
- for other cross-sections equal to 1.0.

For elements subjected to shear with a stress component parallel to the grain, Fig. 3.6 (left), also for shear with both stress components perpendicular to the

grain, Fig. 3.6 (right), the following expression should be satisfied according to EN 1995-1-1:

$$\tau_d \leq f_{v,d}, \quad (3.10)$$

where  $\tau_d$  is the design shear stress; and  $f_{v,d}$  is the design shear strength for the actual condition.

For verification of shear resistance of members in bending, the influence of cracks should be taken into account using an effective width of the member according to EN 1995-1-1:

$$b_{ef} \leq k_{cr} b, \quad (3.11)$$

where  $b$  is the width of the relevant section of the member.

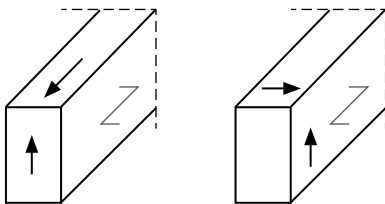
The recommended value for  $k_{cr}$  according to EN 1995-1-1 is:

- 0.67 for solid timber and glued laminated timber;
- 1.0 for other wood-based products in accordance with EN 13986 (EN 13986:2004 +A1:2015) and EN 14374 (EN 14374:2004).

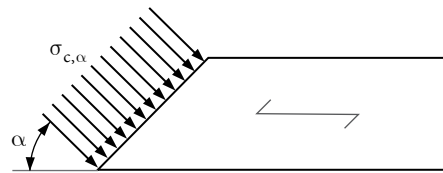
Elements subjected to compression stresses at an angle to the grain should satisfy the following condition according to EN1995-1-1 (see Fig. 3.7):

$$\sigma_{c,\alpha,d} \leq \frac{f_{c,0,d}}{\frac{f_{c,0,d}}{k_{c,90} f_{c,90,d}} \sin^2 \alpha + \cos^2 \alpha}, \quad (3.12)$$

where  $\sigma_{c,\alpha,d}$  is the compressive stress at an angle  $\alpha$  to the grain; and  $k_{c,90}$  is a factor taking into account the load configuration, the possibility of splitting and the degree of compressive deformation.



**Fig. 3.6.** Member with a shear stress component parallel to the grain (left) and member with both stress components perpendicular to the grain (right) (EN 1995-1-1).



**Fig. 3.7.** Compressive stresses at an angle to the grain (EN 1995-1-1).

Elements subjected to the combined bending and axial tension parallel to the grain shall satisfy the following condition according to EN 1995-1-1:

$$\frac{\sigma_{t,0,d}}{f_{t,0,d}} + \frac{\sigma_{m,y,d}}{f_{m,y,d}} + k_m \frac{\sigma_{m,z,d}}{f_{m,z,d}} \leq 1.0, \quad (3.13)$$

$$\frac{\sigma_{t,0,d}}{f_{t,0,d}} + k_m \frac{\sigma_{m,y,d}}{f_{m,y,d}} + \frac{\sigma_{m,z,d}}{f_{m,z,d}} \leq 1.0. \quad (3.14)$$

Elements subjected to the combined bending and axial compression parallel to the grain shall satisfy the following condition according to EN 1995-1-1:

$$\left( \frac{\sigma_{c,0,d}}{f_{c,0,d}} \right)^2 + \frac{\sigma_{m,y,d}}{f_{m,y,d}} + k_m \frac{\sigma_{m,z,d}}{f_{m,z,d}} \leq 1.0, \quad (3.15)$$

$$\left( \frac{\sigma_{c,0,d}}{f_{c,0,d}} \right)^2 + k_m \frac{\sigma_{m,y,d}}{f_{m,y,d}} + \frac{\sigma_{m,z,d}}{f_{m,z,d}} \leq 1.0. \quad (3.16)$$

Further in this chapter the stability calculations of column and beam type elements are provided.

Columns subjected to either compression or combined compression and bending should satisfy the stability condition according to EN 1995-1-1:

$$\frac{\sigma_{c,0,d}}{k_{c,y} f_{c,0,d}} + \frac{\sigma_{m,y,d}}{f_{m,y,d}} + k_m \frac{\sigma_{m,z,d}}{f_{m,z,d}} \leq 1.0, \quad (3.17)$$

$$\frac{\sigma_{c,0,d}}{k_{c,y} f_{c,0,d}} + \frac{\sigma_{m,y,d}}{f_{m,y,d}} + k_m \frac{\sigma_{m,z,d}}{f_{m,z,d}} \leq 1.0, \quad (3.18)$$

where the relative slenderness ratios should be determined as

$$\lambda_{rel,y} = \frac{\lambda_y}{\pi} \sqrt{\frac{f_{c,0,k}}{E_{0.05}}}, \quad (3.19)$$

$$\lambda_{rel,z} = \frac{\lambda_z}{\pi} \sqrt{\frac{f_{c,0,k}}{E_{0.05}}}, \quad (3.20)$$

where  $\lambda_y$  and  $\lambda_{rel,y}$  are slenderness ratios corresponding to bending about the  $y$ -axis (deflection in  $z$ -direction);  $\lambda_z$  and  $\lambda_{rel,z}$  are slenderness ratios corresponding to bending about the  $z$ -axis (deflection in  $y$ -direction); and  $E_{0.05}$  is the fifth percentile value of the modulus of elasticity parallel to the grain.

$$k_{c,y} = \frac{1}{k_y + \sqrt{k_y^2 - \lambda_{rel,y}^2}}, \quad (3.21)$$

$$k_{c,z} = \frac{1}{k_z + \sqrt{k_z^2 - \lambda_{rel,z}^2}}, \quad (3.22)$$

$$k_y = 0.5 \left( 1 + \beta_c (\lambda_{rel,y} - 0.3) + \lambda_{rel,y}^2 \right), \quad (3.23)$$

$$k_z = 0.5 \left( 1 + \beta_c (\lambda_{rel,z} - 0.3) + \lambda_{rel,z}^2 \right), \quad (3.24)$$

where  $\beta_c$  is a factor for members with the straightness limits defined in EN 1995-1-1; and  $\beta_c$  is equal to 0.2 for solid timber and equal to 0.1 for glued laminated timber and LVL.

The beams subjected to either bending or combined bending and compression should satisfy the following stability conditions. In the case where a combination of moment  $M_y$  about the strong axis  $y$  and compressive force  $N_c$  exists, the stresses should satisfy the following condition according to EN 1995-1-1:

$$\left( \frac{\sigma_{m,d}}{k_{crit} f_{m,d}} \right)^2 + \frac{\sigma_{c,0,d}}{k_{c,z} f_{c,0,d}} \leq 1.0, \quad (3.25)$$

where  $\sigma_{m,d}$  is the design bending stress;  $\sigma_{c,0,d}$  is the design compressive stress parallel to the grain;  $f_{c,0,d}$  is the design compressive strength parallel to the grain; and  $k_{c,z}$  is determined according to Equation 3.22.

The relative slenderness for bending should be determined according to EN 1995-1-1:

$$\lambda_{rel,m} = \sqrt{\frac{f_{m,k}}{\sigma_{m,crit}}}, \quad (3.26)$$

where the critical bending stress is determined according to EN 1995-1-1:

$$\sigma_{m,crit} = \frac{M_{y,crit}}{W_y} = \frac{\pi \sqrt{E_{0.05} I_z G_{0.05} I_{tor}}}{l_{ef} W_y}, \quad (3.27)$$

where  $E_{0.05}$  is the fifth percentile value of modulus of elasticity parallel to the grain;  $G_{0.05}$  is the fifth percentile value of shear modulus parallel to the grain;  $I_z$  is the second moment of area about the weak axis  $z$ ;  $I_{tor}$  is the torsional moment of inertia;  $l_{ef}$  is the effective length of the beam, depending on the support conditions and the load configuration, according to Table 3.3;  $W_y$  is the section modulus about the strong axis  $y$ .

For softwood with solid rectangular cross-section,  $\sigma_{m,crit}$  should be determined according to EN 1995-1-1:

$$\sigma_{m,crit} = \frac{0.78b^2}{hl_{ef}} E_{0.05} \quad (3.28)$$

where  $b$  is the width of the beam; and  $h$  is the depth of the beam.

For the cases where only moment  $M_y$  exists about the strong axis  $y$ , the stresses should satisfy the following conditions according to EN 1995-1-1:

$$\sigma_{m,d} \leq k_{crit} f_{m,d} \quad (3.29)$$

where  $\sigma_{m,d}$  is the design bending stress;  $f_{m,d}$  is the design bending strength; and  $k_{crit}$  is a factor which takes into account the reduced bending strength due to lateral buckling.

Table 3.3

Effective Length as a Ratio of the Span According to Eurocode 5  
(EN 1995-1-1:2004 + AC:2006 + A1:2008)

Beam type	Loading type	$l_{ef}/l$ <sup>a</sup>
Simply supported	Constant moment	1.0
	Uniformly distributed load	0.9
	Concentrated force at the middle of the span	0.8
Cantilever	Uniformly distributed load	0.5
	Concentrated force at the free end	0.8

<sup>a</sup> The ratio between effective length  $l_{ef}$  and span  $l$  is valid for a beam with torsionally restrained supports and loaded at the centre of gravity. If the load is applied at the compression edge of the beam,  $l_{ef}$  should be increased by  $2h$  and may be decreased by  $0.5h$  for a load at the tension edge of the beam.

The value of  $k_{crit}$  is determined according to EN 1995-1-1:

$$k_{crit} = 1.0 \text{ for } \lambda_{rel,m} \leq 0.75,$$

$$k_{crit} = 1.56 - 0.75\lambda_{rel,m} \text{ for } 0.75 < \lambda_{rel,m} \leq 1.4, \quad (3.30)$$

$$k_{crit} = \frac{1}{\lambda_{rel,m}^2} \text{ for } 1.4 < \lambda_{rel,m}.$$

For the cases where a combination of moment  $M_y$  about the strong axis  $y$  and compressive force  $N_c$  exists, the stresses should satisfy further condition according to EN 1995-1-1:



$$\left( \frac{\sigma_{m,d}}{k_{crit} f_{m,d}} \right)^2 + \frac{\sigma_{c,0,d}}{k_{c,z} f_{c,0,d}} \leq 1.0, \quad (3.31)$$

where  $\sigma_{m,d}$  is the design bending stress;  $\sigma_{c,0,d}$  is the design compressive stress parallel to grain;  $f_{c,0,d}$  is the design compressive strength parallel to grain; and  $k_{c,z}$  is determined according to Equation 3.22.

### 3.2.3. Serviceability Limit States

Properly designed timber structural elements should also satisfy serviceability limit state requirements according to EN 1995-1-1. Requirements for elements in terms of serviceability are provided in EN 1995-1-1, Section 7. Next to the elastic deflection restrictions, creep deflection should also be satisfied throughout the lifespan of the building.

The main components of simply supported beam's deflection are provided in Fig. 3.8, according to EN 199-1-1.

The symbols in Fig. 3.8 are defined as follows:

$w_c$  is the pre-camber (if it is applied);

$w_{inst}$  is the instantaneous deflection;

$w_{creep}$  is the creep deflection;

$w_{fin}$  is the final deflection;

$w_{net,fin}$  is the net final deflection.

The net deflection below a straight line between the supports,  $w_{net,fin}$ , should be determined according to EN 1995-1-1:

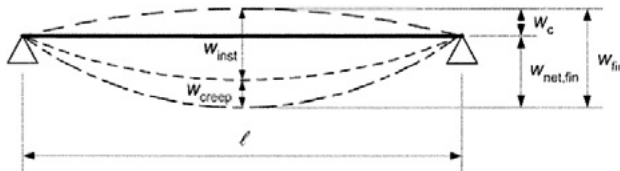


Fig. 3.8. Components of deflection (EN 1995-1-1).

$$w_{\text{net,fin}} = w_{\text{inst}} + w_{\text{creep}} - w_{\text{c}} = w_{\text{fin}} - w_{\text{c}}. \quad (3.32)$$

The recommended limit deflection values are further provided in Table 3.4, according to EN 1995-1-1.

Information on the limiting deflection values is usually provided in the National Annex.

Table 3.4

Examples of Limiting Values for Deflections of Beams

Beam type	$w_{\text{inst}}$	$w_{\text{net,fin}}$	$w_{\text{fin}}$
Beam on two supports	$l/300 \dots l/500$	$l/250 \dots l/350$	$l/150 \dots l/300$
Cantilever beams	$l/150 \dots l/250$	$l/125 \dots l/175$	$l/75 \dots l/150$

## 3.3. MOISTURE PERFORMANCE

---

**Anssi Knuutila,**

Häme University of Applied Sciences

Usually there is a need to control moisture in building. Reasons for this are assurance of good indoor air quality, durability of material and use of building according to its purpose. In wooden buildings wood as a material is not so durable. Wood has a tendency to decay and get mold in favourable moisture and temperature conditions. Unwanted phenomenon with decay is that strength of wood lowers, and mould is an essential visual disadvantage that causes bad smell and unwanted health effect. Because of too high moisture conditions buildings have lower strength and healthy performances.

The essential requirement for moisture control in Finland is as follows:

**Moisture must not cause damage to building and must not cause harmful healthy effect for inhabitants!**

### 3.3.1. Use Purpose of Building, Demand for Moisture Control

---

In public buildings there are many alternative suspended use purposes. The selected use purpose will guide the designing process. It should also be taken into account in architectural design. To meet the demand for moisture control, some reasons in use purpose will arise. Reasons that increase the demand for moisture control are as follows:

- narrow limits in relative humidity of indoor air;
- high moisture product because of use of building;
- low or high indoor temperature;
- situational moist weather condition.

Narrow limits in relative humidity of indoor air will be a reason because some use purpose of building will require that. One example is museums.

In museums, there are narrow limits in indoor air relative humidity because decaying or aging effect should be as small as possible. In museums there should be no corrosion of steel or moisture deformation of wooden material. This leads to a limited value of  $RH = 40-50\%$  in museums.

Moisture product might be high in buildings where we use water, or we use water in a process to produce something. One example of building where moisture product is high is a swimming centre. Moisture product in indoor air might be many kilograms per hour because of evaporation from the swimming pool or wet floor.

Low indoor temperature increases the need for moisture control because normally we lower moisture by ventilation and if we have low indoor temperature, we can use ventilation to lower moisture only for a limited time in year. For example, in an ice rink indoor temperature normally is  $5-10\text{ }^{\circ}\text{C}$ , and in a warmer season ventilation will increase moisture inside and dehumidification should be done in a different way.

Situational moist weather conditions are depending on geographical location of the building. Outer moisture load will be increasing near the sea. Of course, it is not so simple, and because of that locational weather data is an important input in the designing process. Indoor air quality demands moisture control.

Indoor air quality criteria are high in public buildings. The reason for that is the diversity of users. Among those there are probably some people who are extra sensitive to impurities in indoor air. The biggest problem usually is indoors because of microbial growth in the building. To confuse this a little bit, not all microbial growth is harmful. There is no clear scientific distinction between illness and microbial growth in buildings and structures. World Health Organization [WHO] has issued guidelines about dampness and mould. The guidelines were written by a group of authors and prove that there is lots of knowledge about dampness and mould with healthy effect but still there is not enough information to explain all empirical findings (WHO, 2009).

However, there is common understanding that microbial growth lowers indoor air quality (WHO, 2009). In fresh building material there is no microbial growth, but there is a risk for microbial growth if temperature and relative humidity is high and there is a nutrient in the building material for microbes (Fig. 3.9). Of course, microbial growth also needs time. In wood there is a nutrient for microbial growth, so if temperature and humidity conditions are

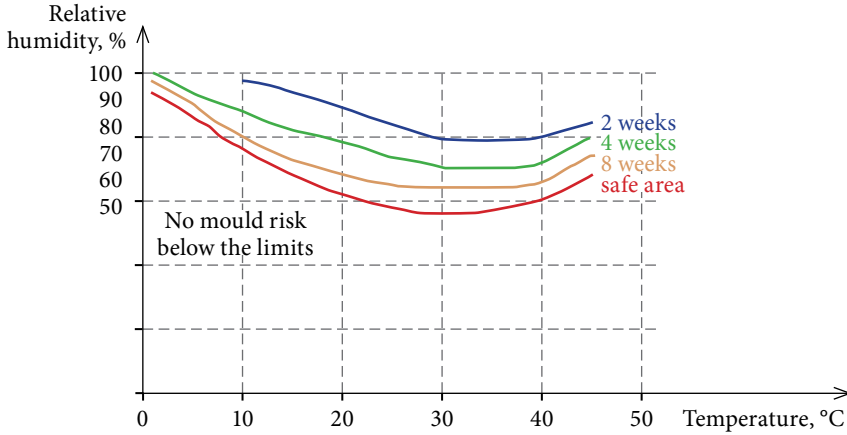


Fig. 3.9. Mould growth dependency on temperature and relative humidity (Viitanen, 2008).

high enough, microbial growth will start eventually. If relative humidity RH is less than 75 %, there is no possibility for microbial growth at all. The limit is dependent on microbial species. Usually the limiting value for mould growth in a building material is 75–80 %.

There are some variations of critical relative humidity in different materials (WHO, 2009). For example, critical relative humidity of concrete is 90–95 %. More cases of critical relative humidity are presented in Table 3.5.

Table 3.5

Critical Relative Humidity for Various Groups of Material (WHO, 2009)

Material group	Relative humidity, %
Wood and wood-based materials	75–80
Paper on plasterboard	80–85
Mineral insulation materials	90–95
Extruded and expanded polystyrene	90–95
Concrete	90–95

To avoid the mould growth, it is necessary to lower relative humidity. As we can see from Fig. 3.9, the average time of mould starting to grow is lower when relative humidity and temperature rise. In buildings there is usually a risk of mould growth and the risk level should be kept down.

It is impossible to keep dry some parts of buildings. For example, façade, roof structure and surfaces in wet rooms are sometimes in direct contact with

liquid form of water. Therefore, relative humidity will be higher than the critical level. To avoid mould growth in those structures, it is necessary to insulate the material or surface coating.

If there is no possibility to avoid microbial growth totally in the material, it is necessary to ensure indoor air quality using a different method.

According to WHO Guidelines (WHO, 2009, p. 94) there are no health-based limited values for microbial contaminant because the relationship between dampness, microbial exposure and health effects cannot be quantified precisely. But dampness and mould-related problems increase the risk of hazardous exposure, and according to the guidelines it is recommended that dampness and mould-related problems shall be prevented.

### 3.3.2. Durability of Wooden Material, Demand for Moisture Control

Durability of wooden material is threatened because of biological reasons. These biological reasons are microbial growth, insects and termites. There are some fungal species that destroy wood. Some insects can make holes in wood and also termites do the same.

Durability of wooden material is threatened because of microbial growth if moisture and temperature conditions are suitable. This microbial growth is related to decay (wood-rot).

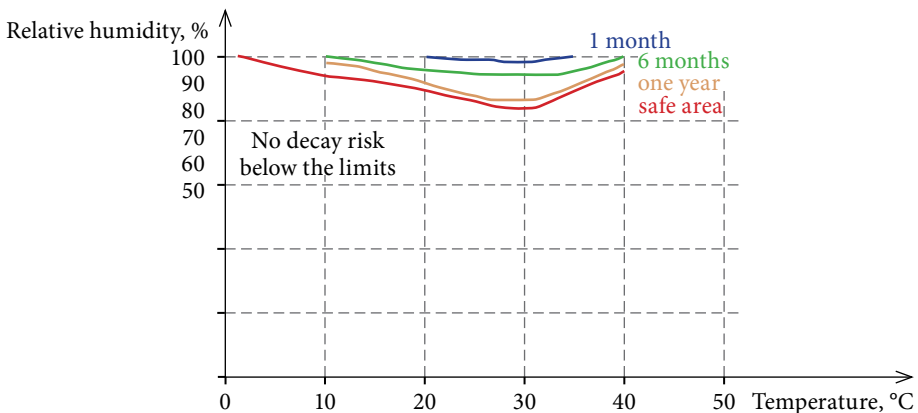


Fig. 3.10. Dependency of decay of wood on temperature and relative humidity.

There are some microbial species that destroy wood. These species normally affect decay. The decay of wood is not possible if relative humidity is less than 90 % (Fig. 3.10).

Also, damages can be happening in wood because of insects and termites. Some insects can destroy wood. These are usually beetles. Some species make holes in wood if the relative humidity is more than 60 %. Some beetles make holes in dry wood. If wood is weak because of decay, there are more species that can live in wood. Also, some insects can live in the bark of wood. With moisture control it is possible also to avoid damages caused by insects.

Durability of wood against decay fungus can be classified in durability classes according to standard EN 15083-1 (CEN/TS 15083-1:2005). There are 5 durability classes. The durability class is determined according to mass loss in a decay test. Durability classes and descriptions are presented in Table 3.6.

Table 3.6

Durability Classes of Wood and Wood-based Products  
(CEN/TS 15083-1:2005)

Durability class	Description	Percent loss in mass
1	Very durable	≤ 5
2	Durable	> 5 to ≤ 10
3	Moderately durable	> 10 to ≤ 15
4	Slightly durable	> 15 to ≤ 30
5	Not durable	> 30

From biological durability aspect there are differences between wooden species. In Finland wooden species pine (*Pinus silvestris*) and spruce (*Picea abies*) are usually listed in durability class 4 - slightly durable. Many other Nordic wood species like birch, alder, aspen, beech, and maple are in durability class 5 – not durable (Viitanen, 1997). Also, there is difference between durability of heartwood and sapwood. Heartwood is more durable compared with sapwood.

With different kind of treatments, it is possible to raise the biological durability. Those treatments are physical and chemical. An example of physical treatment is thermal modification and an example of chemical treatment is pressure impregnation.

In Finland, for example, some wooden species are not used as a frame material. Mostly pine and spruce are used as a frame and facade material.



### 3.3.3. Moisture Control in Construction Process

---

It is possible to avoid moisture damage in many different ways. As explained before, moisture can influence indoor air quality and lower strength of wood. It is possible to affect that with architectural design, structural design, construction process and maintenance of the building.

**With architectural design** it is possible to affect much because an architect usually has a great influence on the geometry of building, selects surface material of the building and initial construction types and design spaces for different use purposes. These are all important because they affect the difficulty class of structural design. The geometry of building affects the external moisture load to facade. If the facade is of wood material, eaves will have a high effect on how much wind driven rain there is to the wooden facade. Also, usually an architect recommends structural types for the structural design of the building. Usually, it is wise to use well known structure types with good experience, but that is not always possible. If there is a need to make something new, it usually means extra costs for structural design, construction workmanship and extra time for construction process to control moisture suitability. Indoor surface material also might affect moisture control. Some surface materials need moisture control to avoid moisture deformation of material. Also, some surface materials have effect on moisture flows because of moisture vapor resistance of the material layer.

**With structural design** we design load bearing structures and also thermal and moisture insulations and other materials and building products of the building. Thus we ensure health, energy efficiency and durability of the building. That part might be separated from building physical design. With structural solution we should control inner and outer moisture load to keep structures dry enough. For example, in wall structures we use a vapor barrier to stop moisture vapor move with diffusion and use outer claddings with ventilation air cap to stop rain water to penetrate into the structure and so on. Also, the selected structures should be fault-tolerant with a low risk for moisture damage. Fault-tolerance means that if there is a small error in construction drawings, construction workmanship, use of building or maintenance, the structures are tolerant to that. Therefore, to use structures and details with good experience is wise. In structural design we select products for structures or by clear performance criteria for materials. Wooden material should be selected to be durable for moisture conditions in the future.

**With HVAC design** we can affect indoor air temperature, moisture and air pressure distribution conditions. These will affect the inner moisture load condition of structures.

**Construction workmanship** is also critical for moisture durability of wooden material. In construction process material should keep dry enough and construction should be done as structural designer has planned to achieve the designed moisture performances. So, we should protect material from rain water and humid air. This is a quality level of workmanship. During construction there might be much building moisture that should dry during the construction process. During construction properties of moisture tolerance of building materials will affect how careful the construction workmanship should be during construction. In Finland it is required to make a moisture controlling plan of the construction process.

### 3.3.4. Moisture Control in Structural Design

---

Structural design includes thermal insulation of envelope, air tightness of envelope, rain tightness of roof and facades, ventilations in structures, moisture barriers, and so on. In Europe there is no standard system for that, but there are standards for different materials and products. This kind of design can be recognized by an expert of building physics.

Geometry of building, surface material and use purpose of different space will affect how complicated the structural design is. That is also a reason why the structural designer gives feedback to the architect about how difficult it is to design and build the structure without a risk of moisture problem. The easiest form of building is usually a cubic form with a high sloped roof with long eaves.

Moisture performance is also connected with strength and stability because moisture content of wood affects the strength properties of wood.

The design solutions for moisture performance in structural design can be of different difficulty classes. If there is nothing special, the difficulty class is ordinary and standard procedure is possible. If the demand for moisture performance is high, or there is need to develop something, the difficulty of moisture design is higher, and it is necessary to use a performance-based design.

### **Standard moisture performance design**

At a normal level a good moisture performance of the whole building and structural types will be selected using a well-known structural solution with good empirical experience. These solutions may depend on the use purpose of the building and on national climatic conditions. Some material suppliers have libraries of examples of structural types on their web page. For example, Finnish Wood Research Oy has worked out a harmonized open standard for wood structure RunkoPES 2.0. (Puuinfo, 2020). There are also structural type drawings with energy, moisture, fire and sound performances.

### **Performance based moisture performance design**

In more general moisture design, there is input data that has an effect for structural design. These input data are:

- climatic conditions in the location where building will be built;
- use purpose and maintaining method of the building.

Climatic conditions will generate **outer moisture load** to the building. Outer moisture load comprises rain, wind driven rain, air humidity, runoff water, ground water and flood.

The use purpose of building affects the **inner moisture load**. Inner moisture load usually is water vapor that rises because of evaporated moisture product to indoor air. In wet rooms inner moisture load is a water vapor product and also is influenced by water flow.

### **Performance based moisture performance design**

Moisture performance of the whole building can be compared with the performance criteria of moisture tolerance. Moisture tolerance can be evaluated with risk analysis in difficult cases where there is no experience (Hens, 2013b). Moisture tolerance should be also taking into account minor faults in workmanship. Moisture performance should be predictable in design process and controllable during and after construction (Hens, 2013a).

**Moisture performance should be predictable in design process and controllable during and after construction.**

It is possible to predict moisture performance of the whole building by calculations. There are simple calculation methods that can be done in a simple way using pen and paper. Also, there are larger and more demanding calculations which usually need numerical calculation methods. These numerical calculations are usually done on a computer with commercial software. Some of these calculations are standardized. For example, there is a standard on predicting the moisture performance of a building element with steady state and reason of moisture movement diffusion (EN ISO 13788:2007). Also, there is a standard on calculating moisture performance of a building element with numerical method (EN ISO 15026:2012).

### 3.3.5. Materials and Products to Control Moisture

---

In structural design we select materials and products for building elements to control moisture. There is a need to know and understand the performance of materials. Various other materials affect the following features of moisture performance of buildings.

#### 1. Vapor barrier

Vapor barrier is usually a membrane with purpose to limit water vapor diffusion. One example is polyethylene film, in Fig. 3.11.

#### 2. Water proofing

There are different kinds of water proofing. Those are liquid form paintable water proofing, flexible sheets of watertight boards. Water proofing is needed to stop liquid form water flow through material (Fig. 3.12).

#### 3. Air barrier

Air barriers control air leakage through the envelope of building. Usually, the



**Fig. 3.11.** Vapor barrier – polyethylene film.



**Fig. 3.12.** Brushable water proofing in wet room.

vapor barrier is also an air barrier. Air barrier with tight joints is generating the airtightness of building. In moisture control air barrier is stopping vapor from moisture convection through the envelope. Air barrier can be also a diffusion-open material.

#### 4. Wind barrier

Wind barrier can be a membrane or board. The purpose for wind barrier is to limit the air flow to thermal insulation layer to avoid the loss in thermal insulation.

#### 5. Building component.

### 3.3.6. Moisture Performance of Building Components

---

Building components are floor, outer wall, roof, sealing and intermediate wall and floor structures. These have performances related to moisture. Moisture tolerance of a timber framed building component is of big interest.

#### Moisture tolerance of building elements

---

Because of water sensitivity of the wood, timber framed constructions are less moisture tolerant compared with massive constructions. To avoid problems, some requirements are presented in book Performance Based Building Design 2 (Hens 2013b, p. 17).

1. Building moisture in studs, plates and joist must dry without damage.
2. Once the construction is finished, rain should no longer seep in and humidify either the sheathing or the timber frame.
3. Studs and plates should not suck water out of capillary porous materials they contact.
4. Annual cumulating interstitial condensate is not allowed, while a too high winter relative humidity lifting moisture ratio in the sheathing and frame beyond 20 %/kg is excluded.
5. Solar driven vapor flow giving moisture build-up in the insulation and moisture deposit against the air and vapor retarder or the inside lining should be avoided.

Structures above foundation can be timber framed structures.

For **floor structures** there are some ways to meet the requirements for moisture tolerance. The floor structure can be with crawl space or plate on ground. The floor structure has a moisture risk because of ground water, capillary moisture in soil, seeping rain water, building moisture and high inside relative humidity. The ground under the building is moist up to relative humidity in the soil reaching 100 % (Hens 2013a, p. 91.)

It is possible to use wood, at a least partly, in floor structures. Risk for mould because of moisture loads should be checked. In Finland, wooden floor structures are usual in floors above crawl spaces but very rare with floors on ground.

Wooden wall structure usually is a timber frame wall structure, CLT frame wall structure or log wall. The walls are with a moisture load of rain and water vapor outside and inside. Also, capillary suction from foundation should be cut before the wooden part.

Wooden facade is constantly in outer weather. Durability of a wooden facade depends on climatic condition and moisture tolerance of wooden material. The rain load to facade depends on the situation, height, direction and eaves of building.

Timber frame should be protected from seeping rain water. Timber frame and CLT-frame is usually protected with facade and ventilated air cap with drainage. Log wall can be without facade, at least in Finland. The design of rain protection of wall structure depends on the load of wind driven rain.

To avoid interstitial condensation and to control the relative humidity inside walls structure, there can be a vapor barrier with necessary moisture resistance. The dimension and the right place of vapor barrier can usually be calculated with Glaser method (EN ISO 13788:2007). In Glaser method water diffusion calculation is done in steady state situation. Sometimes in order to dimension the vapor barrier it is necessary to take into account also the hygroscopic property of the material. In that case there is need to make calculation by the time-dependent method. That means numerical calculation with software where the calculation is based on the difference or element method.

Also, air infiltration should be taken into account when we are estimating the moisture tolerance of wall structure. Because of that there usually is the requirement for air tightness of building element and air pressure difference

level between indoor air and outdoor air.

There are also windows and different kind of details in the wall. In the connections between the wall and window there are details where also rain tightness, drainage and ventilation of wall structure should be designed.

The envelope of a building comprises also roof and top bottom structures. The purpose of a roof structure is to lead rain water outside of walls or to drainage. There are different kinds of roof structures. The main types are low pitched roofs and high-pitched roofs (Ahola, 2013). Difference between these is in slopiness and water proofing methods. In low pitched roof slopiness is less than 1:10 and water proofing is continuous. Usually that is achieved with bitumen membranes. In high pitched roof, water proofing is based on roofing material, underlay and slopiness. Under the underlay there usually is a ventilation space or cavity. The roofing material of high-pitched roofs usually is a bituminous layer, sheet metal or clay or concrete tiles. That can be also wood. For example, wooden tile roof was used historically in churches in Finland, and there were thatched roofs in Denmark (Fig. 3.13).

Under roof there is top bottom with thermal insulation. The requirement for top bottom is to avoid interstitial condensation and mould by vapor barrier and air tight layer.

In roof and top bottom structure there can be also roof windows or a glass roof. Connection between roof windows and other roof structures are special places with high risk of moisture damage.



**Fig. 3.13.** Thatched roof in Denmark, Odense.

### 3.3.7. Moisture Tolerance of Wooden Structure According to the Use Class and Biological Durability Class of Wood

By moisture control it is possible to generate dry environment for users and also for the building material. In standard EN 335:2013 the use classes for timbers are defined. Those use classes are UC1 to UC5.

- USE class 1 (UC1) Indoor
- Use class 2 (UC2) Condensation can occur
- Use class 3 (UC3) In rain:
  - UC3.1 not remain wet for long period
  - UC3.2 will remain wet for long period
- Use class 4 (UC4):
  - Direct contact to ground of fresh water
  - Disfiguring fungi and wood-destroying fungi are possible
- Use class 5 (UC5):
  - Direct contact with sea water

These use classes are classified according to biological risk caused by disfiguring fungi, wood destroying fungi, beetles, and termites (Table 3.7).

Table 3.7

Summary of Use Classes and Relevant Attacking Biological Agents of Wood and Wood-based Products

Use class	General use situation	Occurrence of biological agents				
		Disfiguring fungi	Wood-destroying fungi	Beetles	Termites	Marine borers
1	Interior, dry	-	-	U	L	-
2	Interior, or under cover, not exposed to the weather. Possibility of water condensation	U	U	U	L	-
3	Exterior, above ground, exposed to the weather. When sub-divided: 3.1 limited wetting conditions 3.2 prolonged wetting conditions	U	U	U	L	-
4	Exterior in ground contact and/or fresh water	U	U	U	L	-
5	Permanently or regularly submerged in salt water	U	U	U	L	U

U – ubiquitous in Europe and EU territories

L – locally present in Europe and EU territories



These use classes as examples are presented in Fig. 3.14.

For different use classes there are guidelines for selecting wood species related to biological durability in European standard EN 460:1994. All wood species are durable enough in indoor climate, Use class 1 (Table 3.8).

Table 3.8

Guidance on Durability Classes of Wood Species for Use in Different Use Class (EN 460:1994) (Note that hazard class is marked as a use class nowadays)

Hazard class	Durability class				
	1	2	3	4	5
1	o	o	o	o	o
2	o	o	o	(o)	(o)
3	o	o	o	(o)-(x)	(o)-(x)
4	o	(o)	(x)	x	x
5	o	(x)	(x)	x	x

Key:

- o natural durability sufficient;
- (o) natural durability is normally sufficient, but for certain end uses treatment may be advisable (see Annex A);
- (o)-(x) natural durability may be sufficient, but depending on the wood species, its permeability and end use (see Annex A), preservative treatment may be necessary;
- (x) preservative treatment is normally advisable, but for certain end uses natural durability may be sufficient (see Annex A);
- x preservative treatment necessary.

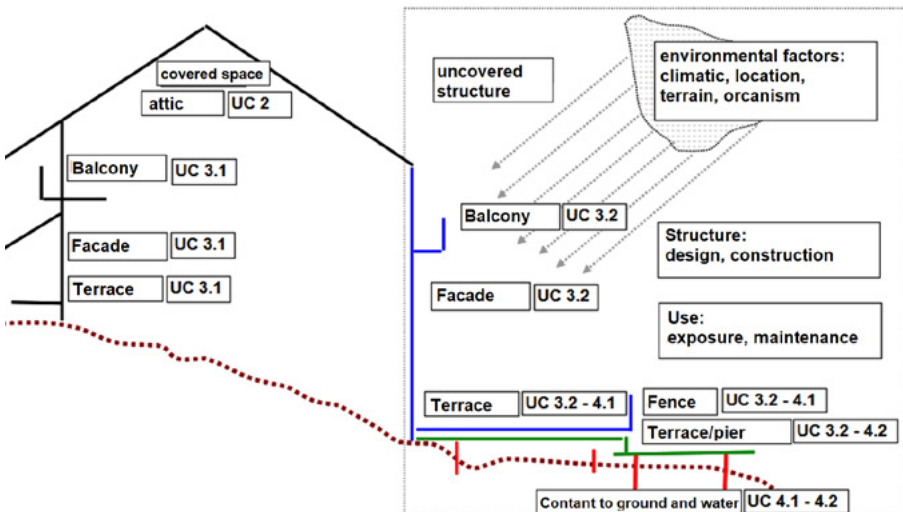
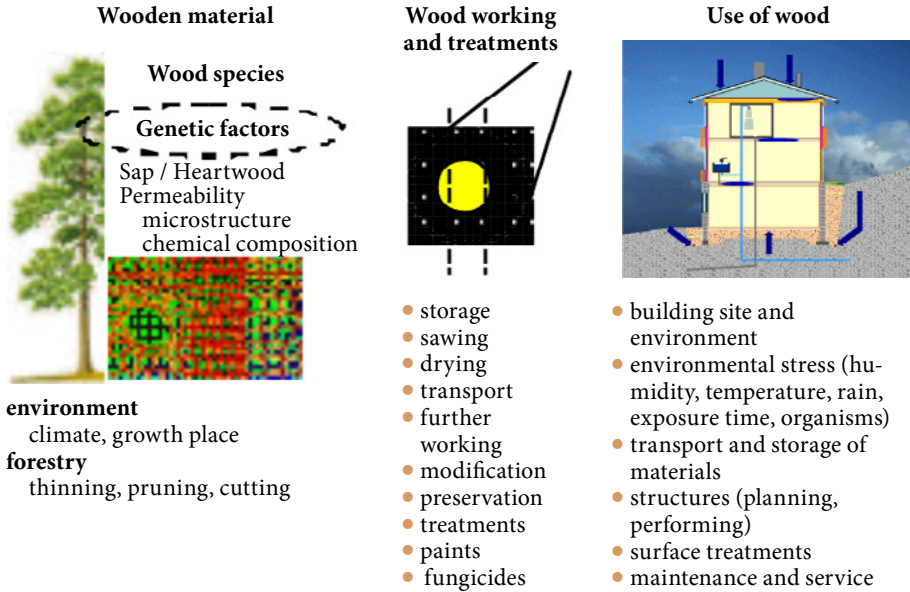


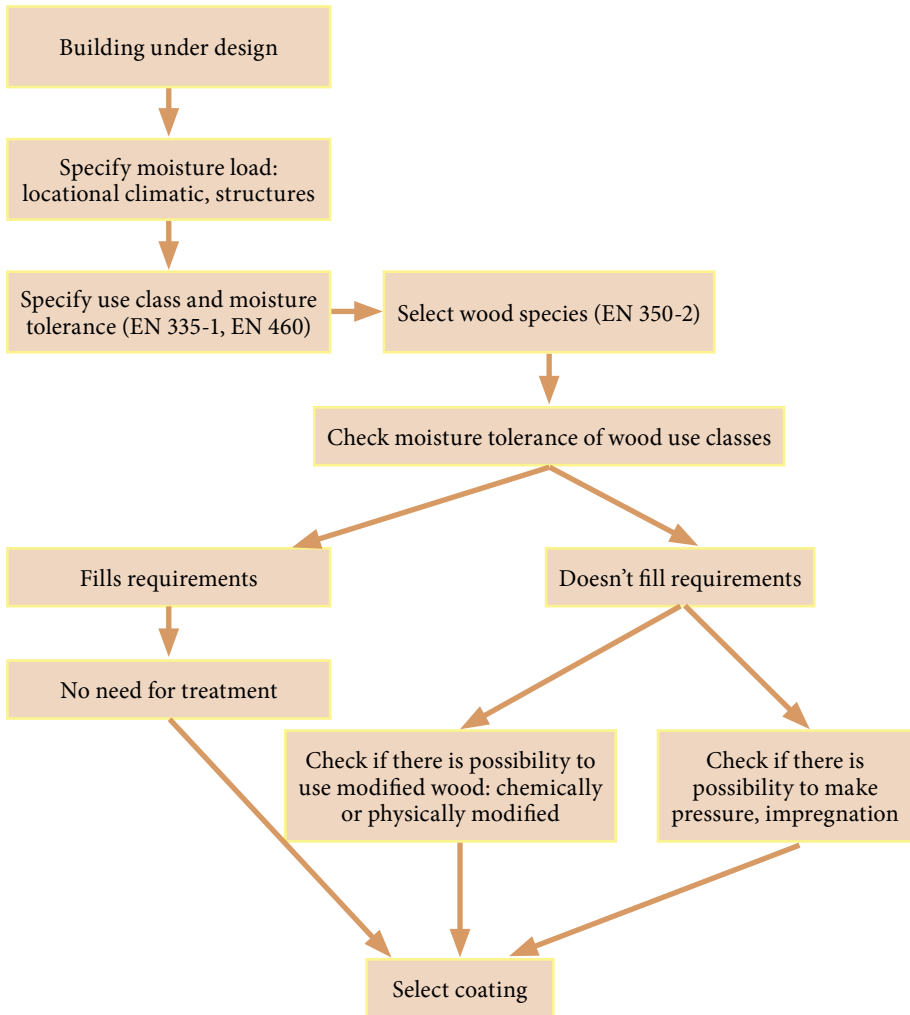
Fig. 3.14. Structures and use class examples (Adapted and translated from (Viitanen, 2004)).

Durability of wood is related to use class and durability class of wood or wood product. Also, those are related to climate. In Fig. 3.15 the factors affecting durability are presented.



**Fig. 3.15.** Factors affecting durability of wooden products (Viitanen et al., 2006).

In design we select structures with materials and check that moisture tolerance is filling. For wooden structure procedure is presented in Fig. 3.16.



**Fig. 3.16.** Procedure of selecting wooden species and treatment for using wood in building (Adapted and translated from Viitanen, 2008).

## 3.4. FIRE SAFETY

---

***Taneli Rasmus,***

Häme University of Applied Sciences

### 3.4.1. Fire Safety in Wooden Public Buildings

---

Public buildings are spaces and also part of the image of an organization (Fig. 3.17). Therefore, they are also subject to high safety, environmental and landscape standards. Public buildings typically have a lot of users not familiar with its safety solutions. Human risks are significant.

Uninterrupted operation and public image are also important in risk management of public buildings. Requirements for the climate impact of construction have increased and favoured wood construction. There is a demand for fire safe wood construction.



**Fig. 3.17.** Pilke building, photo Jussi Tiainen, design Arkkitehtityöhuone Artto Palo Rossi Tikka Oy.

### 3.4.2. Fire Properties of Wood

Wood is a flammable and combustible material. Wood pyrolyzes under the influence of heat. As the temperature rises to 160–180 °C, the lignin and celluloses in the wood begin to decompose. Decomposition intensifies when the material reaches a temperature of 270 °C. When the temperature is 350–360 °C, the surface ignites from a small flame or spark. External radiant heat heats the surface. The temperature at which the surface ignites from a small flame or spark is reached at a heat radiation intensity of about 12 kW/m<sup>2</sup>. An impinging flame can ignite wood as low as 4 kW/m<sup>2</sup> heat fluxes. The spontaneous ignition requires a temperature of approximately 600 °C.

Moisture in wood is removed by evaporation when the temperature of the material rises to 100 °C. Thermal energy is required to evaporate the water. Heat of combustion of dry wood is 17.5 MJ/kg. If the moisture content of the wood is 10 %, the heat of combustion decreases to 12–14 MJ/kg.

There are two main reaction pathways of thermal decomposition of wood, tar- and char-forming reactions. Gaseous pyrolysis products burn with flame and solids with smouldering. Combustion starts when the pyrolysis

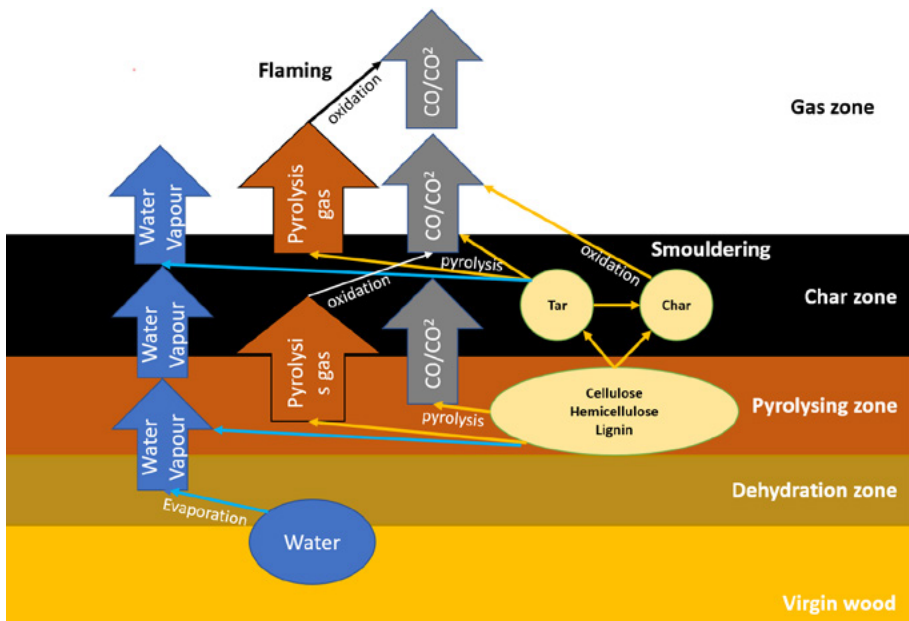


Fig. 3.18. Processes within a burning timber (modified from Bartlett et al., 2019).

products react with oxygen and produce more heat causing a growing chain reaction. The energy released in the reaction heats the burning surface and its surroundings. The fire spreads on the surface as it heats up sufficiently. A value of the charring rate of wood is typically 0.5–1 mm/min. With a load-bearing structure, charring reduces load-bearing capacity.

Charring wood acts as a fuel for fire. The burning rate of the wood is higher soon after ignition, being in the order of 200 kW/m<sup>2</sup>. Later, charring protects the wood and slows down the fire. Thin wood surfaces can burn through, causing the burning rate to increase again (Fig. 3.18).

### 3.4.3. Fire Classification of Wood

Fire test and fire classifications have been harmonized on the EU level. Building materials are divided into categories based on how they ignite and spread fire. The smoke production of the material and the tendency to drip flaming droplets or particles are also defined. Fire classification of construction products is made according to classification standard EN 13501-1:2019. The test methods and classification criteria for fire classes are presented in it.

Tests for material properties are EN ISO 1182:2010 (non-combustibility) and ISO 1716:2018 (calorific value). The flammability properties of the product are determined in accordance with test standards EN 13823:2020 (SBI – single burning item (Fig. 3.19)) and EN ISO 9239-1:2010 (burning behaviour of flooring). Mounting and fixing affects the validity of the classification.

Materials are classified by test in main Classes A1, A2, B, C, D, E and F on the basis of the above. Classes for floorings are A<sub>1fl</sub>, A<sub>2fl</sub>, B<sub>fl</sub>, C<sub>fl</sub>, D<sub>fl</sub>, E<sub>fl</sub> and F<sub>fl</sub>. Additional classes exist for smoke production – Classes s1, s2 and s3, and for burning droplets / particles – Classes d0, d1 and d2.

The European Commission publishes in the Official Journal of the EC lists of products that can be classified without testing. Many wood products are classified without testing (CWT). Non-fireproof wood products are typically in category D if they are at least 9 mm thick and have a density of at least 400 kg/m<sup>3</sup>.

Smoke output of wood is usually Class s2. Wood



Fig. 3.19. SBI test.

products thicker than 10 mm are normally classified as d0. Thinner products and plywood may have a rating of d1. This is due to blast burning of thin materials and delamination of glued products.

Structural sawn timber with a thickness exceeding 22 mm and glulam products with a thickness exceeding 40 mm reach Class D-s2, d0. For panels, particle board and OSB, the classification depends on whether there is an air gap behind the product. Without a gap, the classification is D-s2, d0 and with a gap D-s2, d2. Wood floors are typically in class Dfl-s1.

### 3.4.4. Flame Retardants for Improving the Fire Properties of Wood

---

When unprotected wood burns, pyrolysis produces a lot of tar, which decomposes under the influence of heat into easily combustible gases. Wood flame retardants affect pyrolysis. The wood product is treated with a substance that promotes the carbon reaction pathway instead of tar. In practice, the shielding reduces the amount of pyrolysis products burning in the flame and thus also the heat released. Agents that affect the pyrolysis of wood are typically phosphorus or boron compounds.

The classification of fire-protected wood is determined by tests. The tests are performed according to the standard. Fire protection treatment can significantly reduce heat output values, allowing fire classifications to be transitioned from Class D to Classes C and B. This allows wood to be used more widely in different parts of the public buildings.

The protection of a wood product can be significantly reduced if the wood material is exposed to moisture or weather. Water flowing on the surface, changes in moisture content and UV radiation can reduce the amount of flame retardant in the treated wood material. It is important to ensure the functionality of wood products and the long-term sustainability of their fire protection. The European standard EN 16755:2017 has been developed for this purpose and should be applied. The standard defines three categories of DRF (Durability of Reaction to Fire Performance) for verifying the durability of the fire protection: permanent use in dry indoor areas, permanent use in wet indoor areas, and permanent use in outdoor applications.

Wood can also be covered with cladding fulfil K<sub>2</sub> classes for fire protection.

Fire cladding is having tested ability to protect the wood from the effects of fire for the time indicated in the test. The test is made by EN 14135:2004 standard. Requirements can be set also for other fire properties of the product than fire protection ability.

### 3.4.5. Design for Fire Safety

---

Fire safety regulations vary from country to country. Main principles for fire safety are the same for prescriptive and performance-based codes. Principles for fire safety are: occupants shall be able to leave the building or they shall be rescued, the safety of rescue teams shall be taken into account, load-bearing structures shall resist fire for required minimum duration, the generation and spread of fire and smoke shall be limited and the spread of fire to neighbouring buildings shall be limited.

Objectives are safety of life, loss prevention and environmental protection. Strategy for safety of life can be evacuation, suppression of fire or containment contents between occupants and fire. Loss prevention can be done by containment contents or suppression.

#### **Standard concept of fire safety, prescriptive codes**

---

When prescriptive codes are used, building is designed with regard to fire classes and criteria provided by regulations and guidelines. For example, the evacuation safety can be based on both active and passive elements. Greatest distance to the nearest exit, number of exits and dimensions of exits are regulated in prescriptive codes. There are rules for doors, locks and exit lights. Active fire detection and alarm or sprinkler may lower the level of requirements.

Prescriptive codes give fire classes and criteria for building elements. The order codes give the required fire class and criteria for the building components. The materials are tested and the codes define the minimum class needed. There are material requirements, for example for surfaces and structures. Wood can be used within the limits allowed by regulations. Fire-retardant treatment increases the possibilities of use.



If the wood material or wooden structure passes the requirements, it can be used. Fire scenario is usually 834-11:2014 standard fire curve. External fire curve and hydrocarbon curve can also be used. The components must retain required properties under the standard fire for the required time.

Calculation methods based on fire tests can also be used. For example, the fire resistance of load-bearing structures can be calculated by a method based on the rate of charring. In addition to the charring rate, there can be taken into account the properties of the material, such as its delamination.

## Suppression systems

---

Public buildings often use fire safety technology such as fire alarms and suppression systems. Extinguishing systems such as sprinkler and water mist systems are effective in saving lives and property.

Sprinkler system prevents the spread of fire, ignition of surfaces and flashover which make flames through window possible. Therefore, the sprinkler is an effective protector of wooden surfaces both inside and on the facade. That has been taken into account in prescriptive codes which allow more wood surfaces when building has a sprinkler.

### 3.4.6. Performance based fire safety design

---

There are many types of buildings and fires. Public buildings typically differ from apartments. A fire does not grow in the same way in a small room and a large hall. The standard fire curve and the solutions based on it may not be very suitable for large spaces. It may be appropriate to design the building or part of it performance based, e.g. Joensuu Arena (Fig. 3.20). Performance-based fire safety planning enables fire safety solutions which are fitting exact for the features of the building.

The building can be made on the basis of pre-approved solutions or by fire engineering methods. In the performance-based way, the acceptability of the results can be proved by evaluating the design against absolute criteria (heat, visibility, etc.) or by comparing the fire safety of the design to pre-accepted

reference solution. Comparative analysis can also be done by probabilistic analysis.

CFD and zone model software have been developed for fire simulation. The fire can be simulated and solutions designed based on the simulation results. For example, an evacuation can be planned based on a simulated fire and a calculated or simulated exit time. If the conditions caused by the fire during escape do not become dangerous, the result can be accepted.

When acceptability cannot be found in regulations and tables and there are many different methods, the acceptance criteria and methods used must be defined at the beginning of the process. The documentation of results and methods should be done carefully. There are Nordic and EN standards for process and design.



**Fig. 3.20.** Joensuu Arena, photo Esko Jämsä, design PRO-ARK.

## Detailing

---

Wood is a flammable material that must be considered when building components are designed of wood. Post-flashover apartment fire can break windows and flames contact the facade (Fig. 3.21). A wooden facade can spread fire on its surface or in an air gap if this is not prevented in the plans. Fire can also spread from the facade to the attic. Retardant treatment or fire stops can be used to improve fire safety.

There is a lot of technology in public buildings. Therefore, there are vertical and horizontal shafts and gaps in the buildings. Fire can spread rapidly in vertical shaft because of stack effect. Also, in horizontal shafts, like attics, fire spreads faster than in normal rooms. In hidden spaces fire is detected slowly and it is difficult to extinguish. It is important to prevent the spread of fire into shafts and other hidden spaces, especially if material is flammable.

The wooden structures are connected to each other and to other structures. The joints must withstand the effects of fire. The details are essential for fire safety and must be done with care. By thorough designing and using the right methods, products and technology, a wooden building will become as fire safe as a building made of other materials.



**Fig. 3.21.** The flames spread from the broken window to the wooden facade.

## 3.5. ACOUSTICS AND NOISE-ABATEMENTS

**Carl Mills,**

School of Energy, Construction and Environment, Coventry University

### **Acknowledgement**

Special thanks to Andy Kerr, Technical sales at Rothoblaas for approval of use of information and associated images.

In construction, there are two categories of sound:

- Airborne noise; air carries the sound energy.
- Structural noise; vibration carries the sound through the structure.

Lightweight timber structures do not have high acoustic performance at low frequencies. This is particularly important with sounds of impact and the transmission of structural vibration through the timber construction. It is essential to stop the spread of vibrations in order to control noise transmission.

Sound insulation is fundamental for a healthy and high quality of life. When looking at acoustics and noise-abateMENTS with timber frame buildings, we can consider three areas of critical technical knowledge needed to reduce the impact:

- resilient profiles;
- soundproofing layers;
- sealing products.

In this section we have collaborated with Italian company *Rothoblaas*. *Rothoblaas* is a world leader and provider of high technology solutions in the construction and wood sector. They develop products and services dedicated to the wood carpentry industry and continue to export know-how from the heart of the Italian Alps to the world. We will examine the products developed by *Rothoblaas* and how they are used.

## Resilient profiles

---

Resilient products are elastic separating layers between rigid elements whose main feature is to prevent the transmission of vibrations in the building structure (e.g. impact such as footsteps) (Fig. 3.22). Working at this level of the structure means being able to solve the problem at the source, allowing greater flexibility and tolerance during processing and modification of the subsequent layers, such as thermal and acoustic insulation or coverings and various kinds of dry linings.

Range of resilient products can be found at: <https://www.rothoblaas.com/products/soundproofing/resilient-profiles/xylofon>.

A high-performance resilient profile that ensures acoustic comfort in timber structures and houses is made of a polyurethane compound; it is available in 5 versions from 35 to 90 shore, on the basis of the load it has to support.

Tested and certified for use as a desolidarisation and mechanical interruption layer between building materials, it significantly reduces the transmission of airborne and structural noise (up to more than 15 dB).



Fig. 3.22. Resilient profiles (Rothoblaas, 2020).

### 3.5.1. Cork and Xylofon washers & profiles

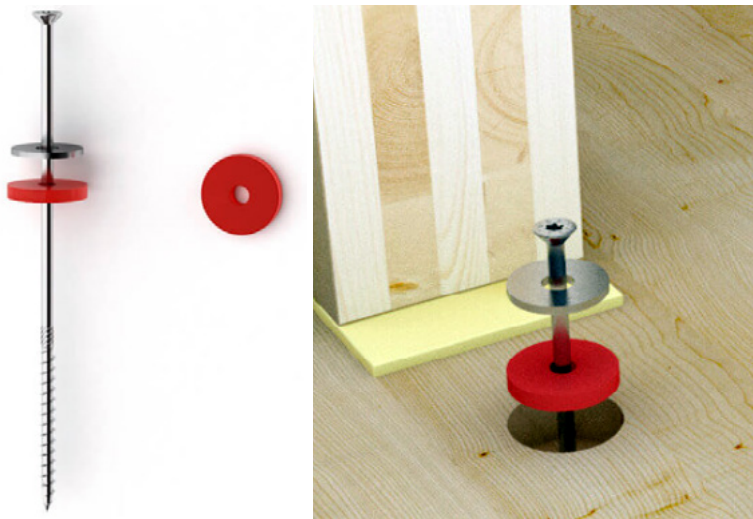
---

Cork is a traditional soundproofing material that significantly reduces airborne and structural noise. It is an ideal solution for sustainable buildings (Fig. 3.23). Cork is waterproof, resistant to damp and does not deteriorate due to load. Soft cork has a lower density and larger dimensions of the granulate, hard cork has a high density and smaller dimensions of the granulate.

XYLOFON washers are a solution for sound insulation which, together with XYLOFON, ensures the continual soundproofing of timber structures (Figs. 3.24–3.26). Other soundproofing products are shown in Fig. 3.27.



**Fig. 3.23.** Use of cork (Rothoblaas, 2020).



**Fig. 3.24.** Wood screws separating washer (Rothoblaas, 2020).



### 3.5.2. Soundproofing layers

---

Separating soundproof layers or membranes can be used in floors, herewith are several options of materials and how they function within the building fabric.

Silent floor soft is shown in Fig. 3.28.

A resilient under screed membrane made of foil and closed cell PE is shown in Fig. 3.29.

Silent floor: Resilient under screed membrane made of foil with bitumen and polyester felt. This material is ideal for separation between wood and concrete.

The highest performing membrane in the *Rothoblaas* range, Silent Floor Evo, is made with foil and recycled polymers (a polyurethane compound), creating an elasticity which offers performance up to 30 dB (Fig. 3.30).



**Fig. 3.25.** Separating washer for WHT angle bracket (Rothoblaas, 2020).



**Fig. 3.26.** Titan silent; for angle bracket resilient profile (Rothoblaas, 2020).

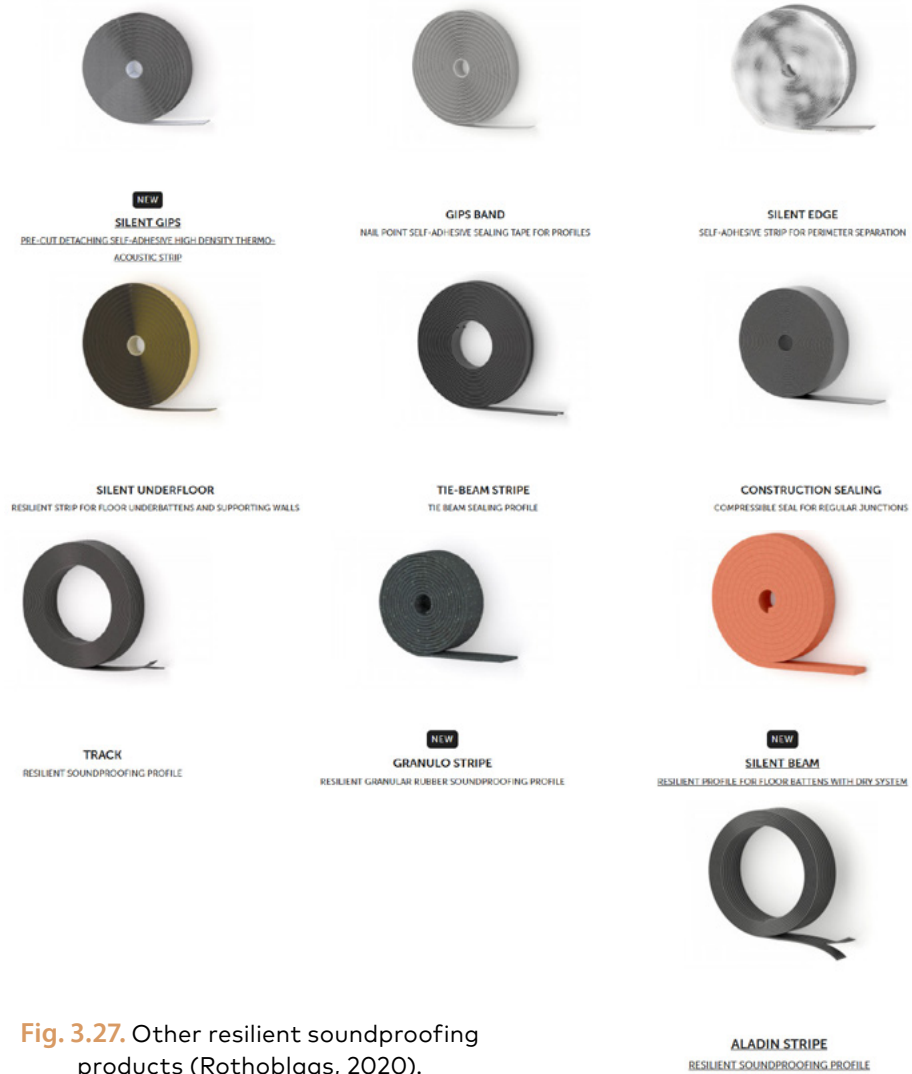


Fig. 3.27. Other resilient soundproofing products (Rothoblaas, 2020).



Fig. 3.28. Silent floor soft (Rothoblaas, 2020).



There are several other materials offered by *Rothoblaas* (Fig. 3.31).

Range of soundproofing layers can be found at: <https://www.rothoblaas.com/products/soundproofing/soundproofing-layers>.



**Fig. 3.29.** A resilient under screed membrane made of foil and closed cell PE (Rothoblaas, 2020).

**Fig. 3.30.** Silent Floor Evo (Rothoblaas, 2020).



**Fig. 3.31.** Other materials (Rothoblaas, 2020).

### 3.5.3. Sealing products

---

Hermetic foam (Fig. 3.32): A high-performance soundproof elastic sealant foam; it works by ensuring the airtightness of all types of cracks between different materials. The closed-cell structure is watertight and airtight, even after trimming.

Frame band (Fig. 3.33): A self-expanding sealing tape for doors and windows from 2 mm to 10 mm.

Kompri band: A self-expanding sealing tape for use on different materials and irregular shapes and surfaces. It prevents acoustic bridges offering sound reductions of up to 58 dB (Fig. 3.34).

Range of sealing products can be found at: <https://www.rothoblaas.com/products/soundproofing/sealing-products>.

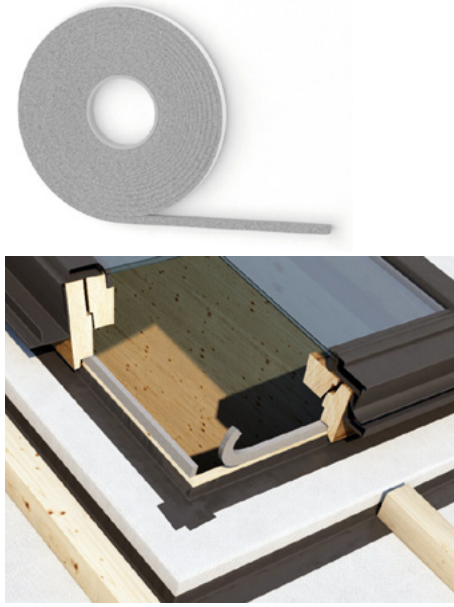
As a final note, these products should all be used within timber buildings as a standard of good practice and are widely available within the construction sector.



**Fig. 3.32.** Hermetic foam (Rothoblaas, 2020).



**Fig. 3.33.** Frame band (Rothoblaas, 2020).



**Fig. 3.34.** Kompri band (Rothoblaas, 2020).

## 3.6. DESIGN OF BUILDING SERVICE SYSTEM

---

***Ole Thorkilsen,***

VIA University College

We will discuss how guideways can be established in large buildings built of wood. There will be a focus on how guideways can be established from different installations and the importance of having an overview of collisions. We will look at how breakthroughs can be established.

Breakthroughs in wet rooms will be looked at. There will be a focus on problems around condensation from installations and what significance it may have for the constructions.

This section will also address some of the challenges to be aware of, installations and guideways that can have a major impact on how the building is designed, also over the life of the building.

### 3.6.1. Solutions in Wood Compared to Concrete Construction

---

When using wood as walls, beams and decks can provide other solutions for how guide weight can be established than when building in concrete, but at the same time there are also places to be aware of as it can have an impact on the life of the building.

It is important that early in the project it becomes an analysis of the building's requirements and function, so that it is possible to begin an analysis of which technical installations are to be in the building.

Once the requirements and function of the building have been determined, the dimensioning of the technical installations can begin.

Dimensioning of the technical installations is run in parallel with the building being designed.

By running this, dimensioning and projecting the side runs mean that the technical installations are thought into the new building and it will be possible to make some architecturally beautiful solutions.

Each country has its own building regulations, so it is important that each country carefully goes in and considers what requirements there are for the respective countries where the project is to be solved.

In this part of the book, there will be suggestions for solutions that can be used as inspiration, but it is not certain that the illustrated and described solutions are legal in all countries.

So, what installations should be included in a building? If recesses are to be made in, for example beams, the supplier will be able to make these recesses with great precision and often with a tolerance down to 2mm, this means that the holes can be made considerably more precise compared to the traditional recesses in concrete.

Because these recesses can be made with such great precision that it is possible to make very beautiful visible solutions, however, it must be clarified that it is very important that the person sitting and drawing on the project knows exactly what sizes these shafts are. It is important to know what will go through these recesses.

### 3.6.2. Ventilation

---

The location of ventilation ducts can have a great impact on the design of a building.

It is important that early in the process you look at the construction and dimensioning of the building's load-bearing system and parallel dimensions of the ventilation system as well as the ducts for the ventilation system.

The ventilation unit is often placed in a separate room due to noise and fire hazard.

The ventilation system is dimensioned in relation to how much air change there must be in the rooms and the respective rooms the system must operate.

The size of the facility can have an impact on the space and the size of the building.

An example is provided in Fig. 3.35 – a building where the ventilation system is located in a technical room, Room 1. The ventilation system must serve Room 2, which is a large room for many people, for example a museum. The building is built up with beams, which is the load-bearing structure for the roof cassettes.

In this example, we will look at different solutions both where the ventilation duct goes through the beam and where the ventilation duct runs under the beams; both options will be assessed, with advantages and disadvantages.

Based on a theoretical calculation, the duct size must have a cross-sectional area of  $9600 \text{ cm}^2$  when blowing in (red) and  $9600 \text{ cm}^2$  when blowing out (blue) in Fig. 3.35.

What design should the ventilation ducts have?

This can have an effect on the height of the beam, which will be looked at circular ducts, square ducts or rectangular ducts; the design of the ventilation ducts can affect the height of the beams if the ventilation ducts are to run through the beams.

For example, if using a rectangular tube, the dimension can be  $80 \times 120 \text{ cm} = 9600 \text{ cm}^2$  (Fig. 3.36).

If using a square pipe, which must have a cross-sectional area of  $9600 \text{ cm}^2$ , the duct dimension must be  $98 \times 98 \text{ cm}$ :

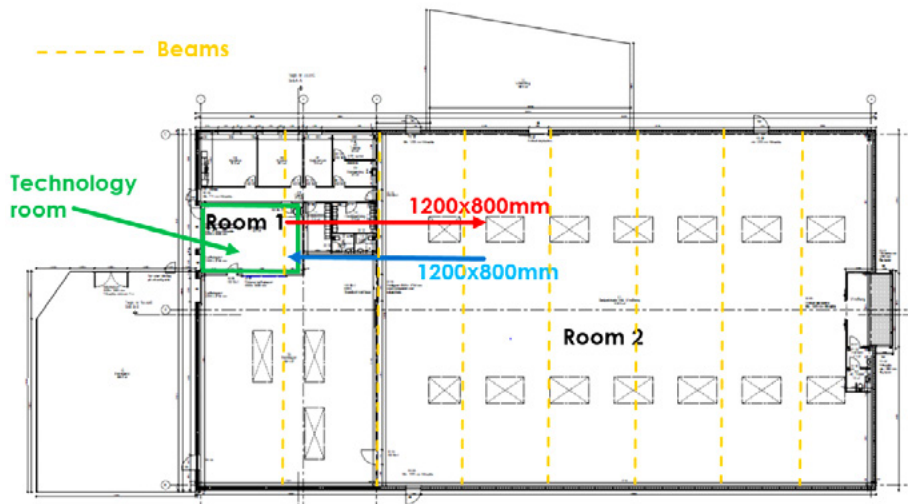
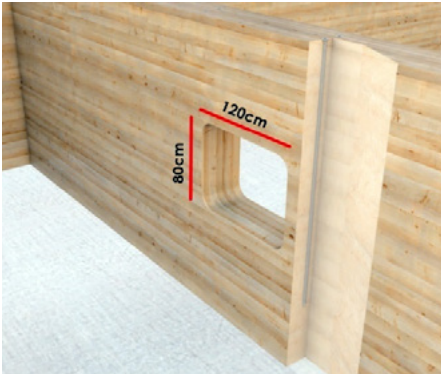
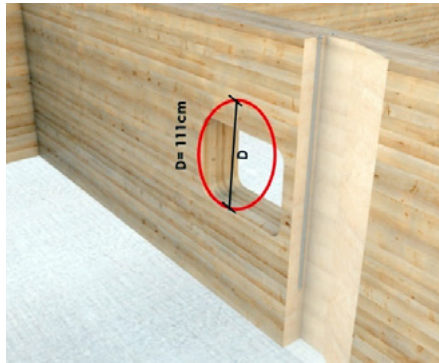


Fig. 3.35. Example.



**Fig. 3.36.** Duct dimension 80×120 cm. **Fig. 3.37.** Duct dimension 98 × 98 cm.



**Fig. 3.38.** Circular pipe (tall wooden buildings).

$$\sqrt{9600} = 97.98 \text{ cm} = 9677 \text{ cm}^2 \text{ (Fig. 3.37).}$$

If a circular pipe is used, the pipe must have a diameter of 111 cm to reach a cross-sectional area of 9600 cm<sup>2</sup>:

$$(111/2) 2\pi = 9600 \text{ cm}^2 \text{ (Fig. 3.38).}$$

If the ventilation ducts are to break through load-bearing beams, this will have an effect on the dimensioning of the beam, as a breakthrough will reduce the load-bearing capacity of the beam; if the ventilation system is paced under a beam, it will have an effect on the free ceiling height in the building.

So, the design and dimensioning of the ventilation ducts as well as the location of the ventilation ducts can have an important significance for the building.

It will also be possible to split ventilation ducts and reduce the duct sizes, the number of pipes will thereby be increased, by the simple calculation the area





**Fig. 3.39.** Cross-sectional area.

can be halved; always make a control calculation to ensure that the correct air change comes to the room.

If we work with a pipe being dimensioned for a cross-sectional area of  $9600\text{ cm}^2$  and dividing it into 2 ducts, the cross-sectional area will be half  $9600/2 = 4800\text{ cm}$  (Fig. 3.39), which means that the ventilation duct is reduced down to half the area.

By splitting the ventilation duct, it is possible to reduce the total height of the beam.

This is the simple calculation that should always be made to ensure that the respective air volumes are still complied with.

By reducing the height of the beam, the price of the beam will also be cheaper, then it must also be considered that more recesses must be made in the beams, there will be more ventilation pipes and more wages, so there are many things to consider.



**Fig. 3.40.** Ventilation ducts under the load-bearing beams.

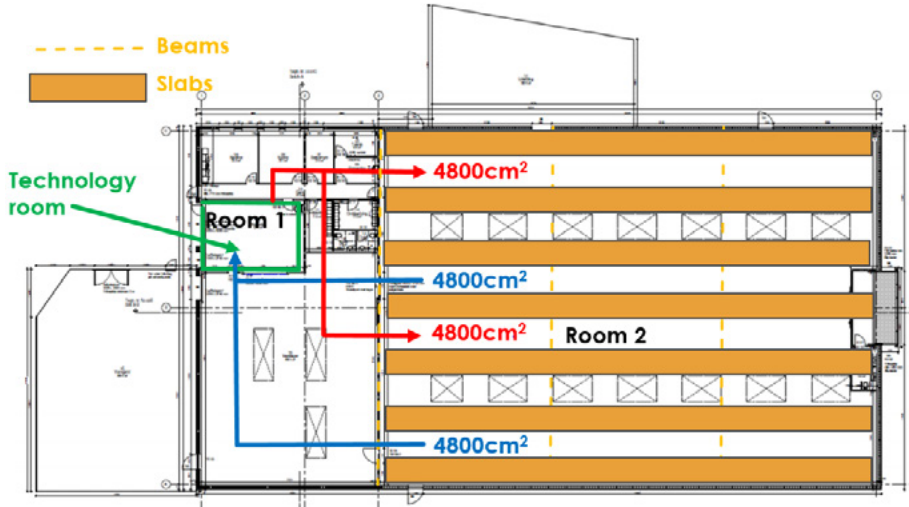


Fig. 3.41. Load-bearing slabs laid at a distance.

But it will also be possible to run the ventilation ducts under the load-bearing beams; by running the ventilation ducts under the load-bearing beams the height of the beams can be reduced to a minimum, however, one must be aware that with this solution the ceiling height is reduced, so the legislation must be checked on whether there is a requirement for a minimum height (Fig. 3.40).

If load-bearing slabs are laid at a distance and closed with a light construction between slabs, it will be possible to reduce the number of load-bearing beams, see Fig. 3.41.

Above the beams and between slabs it will be possible to run installations such as ventilation pipes, fire extinguishing, heating pipes, electric cables (see Fig. 3.42);



Fig. 3.42. Installations above the beams and between slabs.



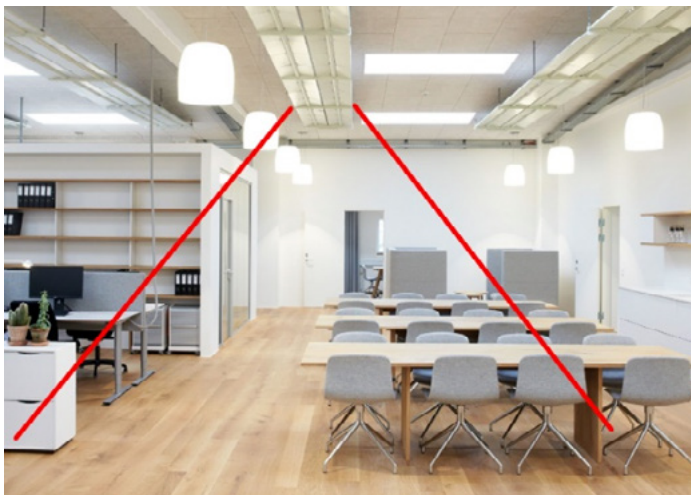
**Fig. 3.43.** Duct roads closed between the load-bearing CLT slabs.

it makes it easy to inspect these pipes and cable ducts, it will also be possible to hide these duct roads (see Fig. 3.43 – here it is closed between the load-bearing CLT slabs).

### 3.6.3. Heating

---

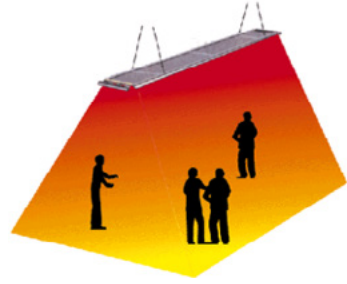
In this section we will look at some of the ways to heat large wooden buildings. Dimensions of the heating system will not be made, but only different possibilities for heating and on guideways for pipes will be looked at.



**Fig. 3.44.** Radiators placed in the ceiling.

## Radiators

Radiators can be placed in the ceiling, they emit heat via radiant heat (Fig. 3.44); it is important to assess at what height and how close these radiators are; the piping can either be run visibly or milled into the walls. So, depending on which manufacturer is used, a calculation must be made so that there can be sufficient heat for the people who use the building (Fig. 3.45).



**Fig. 3.45.** Heating of the premise (Receent, 2019).

It can also be odd to do the heating with radiators placed on the walls by either milling the radiator into so that it is flush with the wall surface (Fig. 3.46) or outside the wall (Fig. 3.47). If the radiator mills into the walls, it will reduce the thickness of the wall where the radiator is located, which can affect the load-bearing capacity of wall elements, fire requirements and sound requirements to ensure that the wall-gen can still maintain.

The piping to the radiator can be placed visible or milled into the wooden construction.

It will also be possible to make underfloor heating. The underfloor heating can be done in light constructions made of wood and aluminum which are



**Fig. 3.46.** Milling the radiator into wall surface (Hudevad, 2019a).



**Fig. 3.47.** Radiator outside the wall (Hudevad, 2019b).



located on or between the deck elements. The advantage of this underfloor heating system is that it has a fast effect, so if the temperature rises quickly due to the sun's rays, the thermostat for the floor heating will close and the floor heating will shut down quickly, as only the aluminum plate is heated and this plate is only 1.5 mm thick it will therefore give off the heat quickly.

It can be an advantage to use a concrete construction on top of a CLT cover element. The concrete can maintain the right sound requirements, have a stabilizing ability for the building or a fire technical function. This concrete construction can be used to run a floor heating in the concrete by drawing heating pipes in the concrete, which heat the concrete surface which then gives off the heat to the room.

The concrete has a good ability to accumulate heat from the heating hoses which are embedded in the construction. It is important that when the concrete is cast on top of a wooden element, there is a waterproof membrane between the wood so that no moisture pulls from the concrete slab down into the wooden structure, as this can cause mould in the wooden structure.

Figure 3.48 shows a green waterproof membrane on top of the insulation, which does not allow heat penetrate into the underlying space.

The insulation is built on ESB concrete which has been used for guideways for cold and hot domestic water and conveyance of water for installations.

Pipes that can form condensation, it can be ventilation pipes, cold and hot domestic water, and drain pipes, must be insulated so that no condensation is formed. If condensation is formed, a cover element of wood will be dampened, which will cause degradation of the wooden element.



**Fig. 3.48.** Green waterproof membrane on top of the insulation (Rothoblaas, 2019).

### 3.6.4. Bathroom

If bathrooms are made of wood, it is important to consider how it is done and what materials are used. There must be the right slope towards the drain that is in accordance with the recommendations for the respective countries, see Fig. 3.49.

The new CLT elements make it possible to mill the rewarding drop into cover elements so that you are sure that the water is led to the drain, see Fig. 3.50.

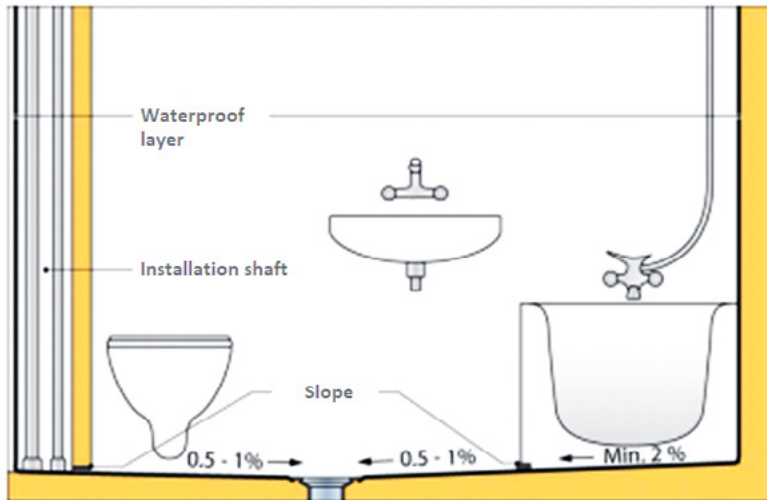


Fig. 3.49. Bathroom installations (SBI 252 Vådtrum).



Fig. 3.50. Rewarding drop.

It is important that all joints are completely tight to water, not least when the substrate in a wet room is made of wood. At drains there must be stricter supervision regarding the design; it is important that an approved membrane is used for the purpose.

At drains, there will be a high water impact; drains and membranes that are approved for the purpose must be used (Fig. 3.51).

Remember to insulate the pipes where there is a risk of condensation because condensation will cause the wood element to become damp, and this wetting will cause decomposition of the wood element (Fig. 3.52).

Penetrations become leaky and wood is discarded if these installations are hidden. It often takes a long time before these leaks are discovered, and this can have major consequences for the life of the building (Fig. 3.53).



**Fig. 3.51.** Drains and membranes (Blucher, 2020).



**Fig. 3.52.** Pipes (Byggeskadefonden, 2020).



**Fig. 3.53.** Leaks (Byggeskadefonden, 2020).



Bathrooms made of heavy materials such as concrete are preferable (Fig. 3.54). Concrete has the property of being very dimensionally stable at indoor temperature and form a good base for waterproofing a wet room. Concrete does not decompose in the event of leaks, such as penetrations or wet room protection. In bathrooms built of wood, there will be a risk that leaks will lead to mould and rot in constructions.



**Fig. 3.54.** Finished bathroom made of concrete (Byggeskadefonden, 2020).

### 3.6.5. Penetrations in the outer walls

Penetrations in the outer walls of wooden elements are important to be made tight so that no convection occurs. If convection occurs, high humidity can pass through the outer wall and release moisture to the wood and thereby there may be a risk of mould or fungal infestation with consequent degradation (Fig. 3.55).

Because convection does not occur at penetrations, sealing cuffs can be used; they will be able to close tightly to the pipe and the wooden wall so that no convection occurs (Fig. 3.56).

In this section, we have a look at a small part of the Building Service in a building where the primary structures are built of wood.

The fact that the buildings are primarily built of wood can provide new and different construction methods.

There must be a lot of focus on the wooden structures not being exposed to moisture, for example from condensation, building moisture, leaky installations, as this can have a great impact on the life of the building.

Wood is a building material we have built with for many years and will continue to build with. Wood as a building material must be treated with care, but this applies also to other building materials.

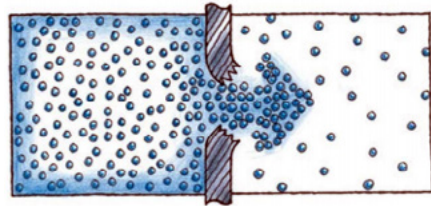


Fig. 3.55. Convection (Isover, 2020).



Fig. 3.56. Sealing cuffs (Rothoblaas, 2019).

## REFERENCES

- Ahola, M. (2013). *Roof system manual*.  
[https://www.kattoliitto.fi/wp-content/uploads/pdf/Roof\\_systems\\_manual.pdf](https://www.kattoliitto.fi/wp-content/uploads/pdf/Roof_systems_manual.pdf)
- Autodesk Revit®. (2020). *Autodesk Revit® Learning*.  
<https://help.autodesk.com/view/RVT/2020/ENU/>
- Bartlett, A. I., Hadden, R. M., & Bisby, L. A. (2019). A Review of Factors Affecting the Burning Behaviour of Wood for Application to Tall Timber Construction. *Fire Technology*, 55, 1–49.
- Blucher. (2020). *Products*. <https://www.blucher.com/>
- Byggeskadefonden. (2020). Images.
- CEN/TS 15083-1:2005 Durability of wood and wood based product. Determination of the natural durability of solid wood against wood-destroying fungi, test methods. Part1: Basidiomycetes*. Suomen standardisoimisliitto, Helsinki.
- EN 13501-1:2019 Fire classification on construction products and building elements. Part 1: Classification using data from reaction to fire tests*. CEN.
- EN 13823:2020 Reaction to fire tests for building products. Building products excluding floorings exposed to the thermal attack by a single burning item*. CEN.
- EN 13986:2004 +A1:2015 Wood-based panels for use in construction – Characteristics, evaluation of conformity and marking*. CEN.
- EN 14080:2013 Timber structures. Glued laminated timber and glued solid timber. Requirements*. CEN.
- EN 14081-1:2016+A1:2019 Timber structures. Strength graded structural timber with rectangular cross section. General requirements*. CEN.
- EN 14135:2004 Coverings. Determination of protection ability*. CEN.
- EN 14279:2004+A1:2009 Laminated veneer lumber (LVL). Definitions, classification and specifications*. CEN.
- EN 14374:2004 Timber structures. Structural laminated veneer lumber. Requirements*. CEN.
- EN 16755:2017 Durability of reaction to fire performance. Classes of fire-retardant treated wood products in interior and exterior end use applications*. CEN.
- EN 300:2006 Oriented strand boards (OSB). Definitions, classification and specifications*. CEN.
- EN 335:2013 Durability of wood and wood-based products. Use classes: definitions, application to solid wood and wood-based products*. CEN.
- EN 460:1994 Durability of wood and wood-based products. Natural durability of solid wood. Guide to the durability requirements for wood to be used in hazard classes*. CEN.

- EN 636:2012+A1:2015 *Plywood. Specifications*. CEN.
- EN ISO 1182:2010 *Reaction to fire tests for products — Non-combustibility test*. CEN.
- EN ISO 13788:2007 *Hygrothermal performance of building components and building elements. Internal surface temperature to avoid critical surface humidity and interstitial condensation Calculation methods*. CEN.
- EN ISO 13788:2012 *Hygrothermal performance of building components and building elements. Internal surface temperature to avoid critical surface humidity and interstitial condensation. Calculation methods*. CEN.
- EN ISO 15026:2012, *Hygrothermal performance of building components and building elements. Assessment of moisture transfer by numerical simulation*. CEN.
- EN ISO 1716:2018 *Reaction to fire tests for products – Determination of the gross heat of combustion (calorific value)*. CEN.
- EN ISO 9239-1:2010 *Reaction to fire tests for floorings – Part 1: Determination of the burning behaviour using a radiant heat source*. CEN.
- EN 1995-1-1:2004 + AC:2006 + A1:2008 (2004) *Eurocode 5: Design of timber structures – Part 1-1: General – common rules and rules for buildings*. CEN.
- EN 1995-1-1:2004 + AC:2006 + A1:2008 (2004) *Eurocode 5: Design of timber structures – Part 1-1: General – common rules and rules for buildings*. CEN.
- European Parliament & Council of the European Union (2008). *Abnormal road transports*.
- Hens, H. (2013a). *Performance based building design 1: from below grade construction to cavity walls*. Wilhelm Ernst & Sohn.
- Hens, H. (2013b). *Performance based building design 2: from timber-framed construction to partition walls*. Wilhelm Ernst & Sohn.
- Hudevad. (2019a). *Hudevad - Consilio*. <https://hudevad.com/en/hudevad-consilio>
- Hudevad. (2019b). *Hudevad – Integral*. <https://hudevad.com/en/hudevad-integral>
- ISO 834-11:2014 *Fire resistance tests — Elements of building construction — Part 11: Specific requirements for the assessment of fire protection to structural steel elements*. International Organization for Standardization.
- Isover. (2020). *Saint-Gobaint 2020 Fugt*. <https://www.isover.dk/fugt>
- Neufert, E. (2018). *Bauentwurfslehre* (42th ed.). Springer.
- Nissen, H. (1972). *Industrialized building and modular design*. Cement and Concrete Association.
- Puuinfo. (2020). *RunkoPES 2.0 suunnitteluohjeet*. <https://puuinfo.fi/suunnittelu/ohjeet/runkopes-2-0/>
- Recent. (2019). *Strålevarme-vand*. <http://www.recent.dk/?page=showpage&id=32>
- Rothoblaas. (2019). *Rothoblaas*. <https://www.rothoblaas.dk/>
- Rothoblaas. (2020). *Resilient products*. <https://www.rothoblaas.com/products/soundproofing/resilient-profiles/xylofon>

Stora Enso. (2012). *Wood products*.

Thanoon, W.A., et al. (2013). *The essential characteristics of industrialised building system*. Universiti Putra Malaysia Faculty of Engineering.

Trikha, D.N. (1999) Industrialised building systems. Prospects in Malaysia. *Proceedings of World Engineering Congress*, Malaysia.

Viitanen, H. (2004). *Resistance, durability, damage and service life*. Cost E 37.

Viitanen, H. (2008). *Puutavaran kestävyys ja valinta. Rakentajain kalenteri 2008*. Helsinki: Rakennustieto Oy.

Viitanen, H., Metsä-Kortelainen, S., Saranpää, P., Laakso, T., Iitti, H., Löija, M., Paajanen, L., Harju, A., & Venäläinen, M. (2006). Service life and biological durability of wooden products, "Optikesto", In *Internal Symposium on Applied Materials, VTT Symposium 244* (pp. 268–277). VTT Technical Research Centre of Finland.  
<https://www.vttresearch.com/sites/default/files/pdf/symposiums/2006/S244.pdf>

Viitanen, H. (1997). *Suomalaisen puun luontaisen lahonkestävyyden hyödyntäminen, Metsätieteen aikakauskirja*. <https://metsatieteenaikakauskirja.fi/pdf/article6368.pdf>

WHO. (2009). *Guideline for Indoor Air Quality, Dampness and Mould*. Geneva: World Health Organization.  
[http://www.euro.who.int/data/assets/pdf\\_file/0017/43325/E92645.pdf](http://www.euro.who.int/data/assets/pdf_file/0017/43325/E92645.pdf)



# Chapter 4

## Management and Leadership in Construction Project

*Jari Komsu*

**4.1. Construction Project Management**

**4.2. Construction Project Stages**

**4.3. Management and Leadership**

**4.4. Safety Management**

**4.5. Quality Management**

**4.6. Principles of Making Construction Schedule**

**References**



**Jari Komsa,**

Häme University of Applied Sciences

## 4.1. CONSTRUCTION PROJECT MANAGEMENT

---

Construction project management requires a wide range of skills. Not only one should be technically innovative but also have expertise of various leadership and communication skills. Construction project management has been defined in different ways, but, in general, regardless of the nature of the project there always should be a person or several persons who are fully aware in which state the project is.

Very straightforward example would be to design and build a small house for a dog. At first it sounds like a very easy task. However, it includes the same principles and stages as larger building projects in which one can make several mistakes.

This kind of task was given a few years back to our first term construction engineering students. Majority of the students did not have previous experience of designing buildings at all. One might think, what was the purpose of this task? There are hundreds of different kinds of dogs. From tiny ones up to large breeds such as St Bernard. In this case the customer is a dog with different kind of needs. Firstly, one should know what are the needs of your customer. Some original wild breeds would use your design doghouse roof top only for observing what is going on in the neighbourhood. The next step is to figure out environmental conditions. What is the climate zone, size of a plot, neighbourhood, average temperature, yearly rainfall, heating need, sustainable healthy materials, foundation, floor, frame and roof structures which would last the design lifetime of the building? Interestingly, there were as many different solutions to this task as there were students.

Before diving deeper into project management, it is necessary to define the term 'project'. According to Cambridge Dictionary it is: "A piece of planned work or activity that is finished over a period of time and intended to achieve a particular purpose." In construction industry a project is temporary and



has a defined beginning and end. Therefore a project has a defined scope and precisely estimated resources. Traditionally construction projects are unique (Fig. 4.1), and people from different organizations and locations are working together only once for the very project.

In general, there are three sectors of construction: buildings, infrastructure and industrial. Building construction is usually further divided into residential and non-residential. Infrastructure, also called heavy civil or heavy engineering, includes large public works, dams, bridges, highways, railways, water or wastewater and utility distribution. Industrial construction includes offshore construction (mainly of energy installations), mining and quarrying, refineries, chemical processing, power generation, mills and manufacturing plants.

In this chapter we are mainly focusing on residential and non-residential buildings, which allows us to study more about how to manage buildings that are meant to be lived in.



**Fig. 4.1.** Snow Castle Bar from plane ice, Levi Mountain resort in Finnish Lapland, 12/2020.

## 4.2. CONSTRUCTION PROJECT STAGES

Construction management or construction project management (CPM) is the overall planning, coordination and control of a project from the beginning to completion (Fig. 4.2). CPM is aimed at meeting a client’s requirement to produce a functionally and financially viable project.

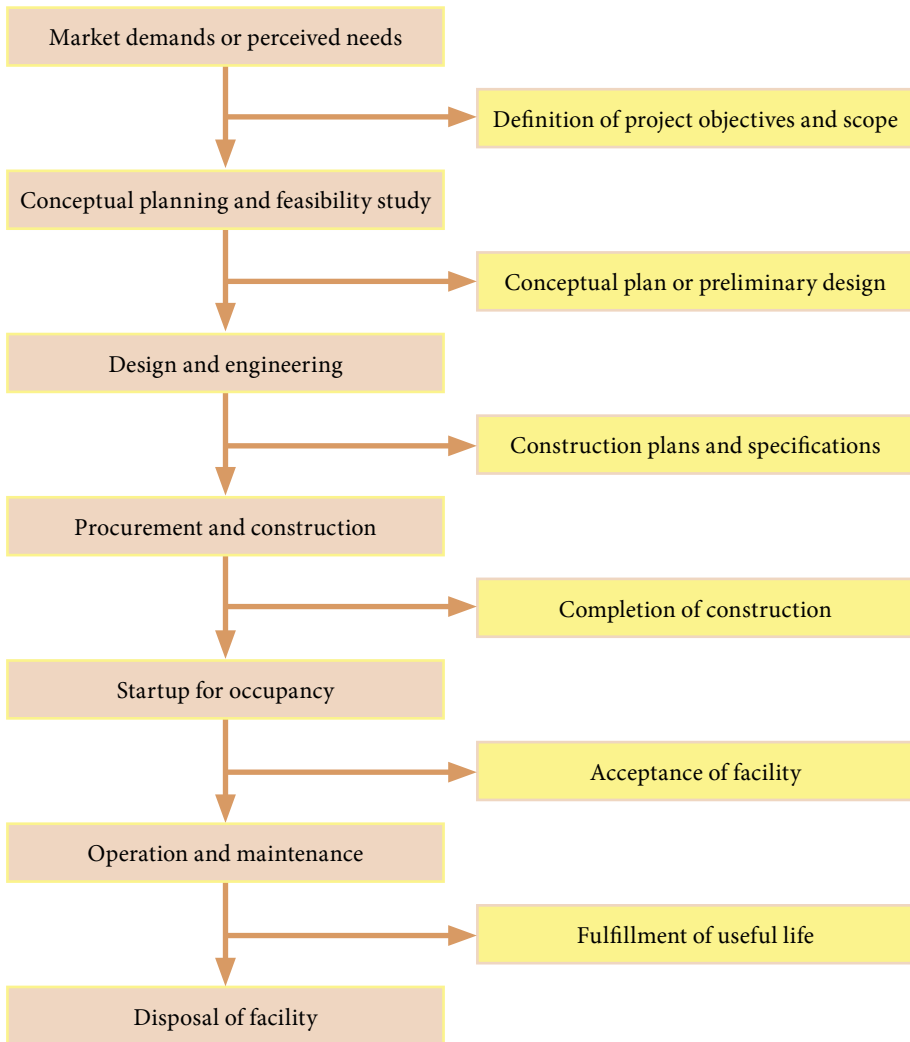


Fig. 4.2. Project life cycle of a constructed facility (Hendrickson, 2008).

Of course, the stages of development in Fig. 4.2 may not be strictly sequential. Some of the stages require iteration, and others may be carried out in parallel or with overlapping time frames, depending on the nature, size and urgency of the project. Furthermore, an owner may have in-house capacities to handle the work in every stage of the entire process, or it may seek professional advice and services for the work in all stages. Understandably, most owners choose to handle some of the work in-house and to contract outside professional services for other components of the work as needed. By examining the project life cycle from an owner's perspective, we can focus on the proper roles of various activities and participants in all stages regardless of the contractual arrangements for different types of work.

### 4.2.1. Feasibility Study and Design

---

Feasibility studies are preliminary studies undertaken in the very early stage of a project. They tend to be carried out when a project is large or complex, or where there is some doubt or controversy regarding the proposed development. If an environmental impact assessment (EIA) is required, this may involve assessments best undertaken as part of feasibility studies (Designing Buildings Wiki, n. d.). Property developer would firstly start finding the right spot for the project. Same housing project in a wrong place can be financially disastrous. In general, construction costs are almost the same regardless of the location in the country. Naturally, increased logistics and extra foundation costs will make a difference, but more importantly the price of land.

The purpose of feasibility studies is to:

- establish whether the project is viable;
- help identify feasible options;
- assist in the development of other project documentation such as the business case, project execution plan and strategic brief (Designing Buildings Wiki, n. d.).

For large or complex projects, there may be a few different feasibility studies carried out, sometimes requiring different skills and considering issues such as:

- planning permission;
- the likelihood that an environmental impact assessment will be required;

- other legal / statutory approvals;
- analysis of the budget relative to client requirements;
- assessment of the potential to re-use existing facilities or doing nothing rather than building new facilities;
- assessment of any site information provided by the client;
- site appraisals, including geotechnical studies, assessment of any contamination, availability of services, uses of adjoining land, easements and restrictive covenants, environmental impact, and so on;
- considering different solutions to accessing potential sites;
- analysis of accommodation that might be included or excluded;
- assessment of the possible juxtaposition of accommodation and preparing basic stacking diagrams;
- evaluation of operational and maintenance issues;
- appraisal of servicing strategies;
- program considerations;
- procurement options (Designing Buildings Wiki, n. d.).

Various stakeholders, statutory authorities and other third parties may need to be consulted during the preparation of feasibility studies. The assessments carried out should be presented in a structured way so the client can decide whether to proceed to the next stage. Wherever possible, any information prepared or obtained should be in a format that can be readily shared and used and should be stored and named in a way consistent with the long-term project and operational needs (Designing Buildings Wiki, n. d.).

### 4.2.2. Bid and Tendering

---

A bid is given to the owner by construction managers that are willing to complete their construction project. A bid tells the owner how much money they should expect to pay the construction company for them to complete the project. Bids are either open or closed. An open bid is generally used for public projects. Contractors can submit their bid due to public advertising. Majority of contractors in private projects are chosen via closed bids. A selection of contractors is sent an invitation for bid without advertising the project openly. It is benefactor to have longer co-operation with contractors.

### 4.2.3. Selection of Contractor

---

Selecting a contractor is one of the most difficult aspects of project management. It is why most large companies have an entire department hired for project procurement. Contractors want the work, but how do we know they are not too busy and will start our project later than agreed? How do we know they are as capable as they say? (Roseke, 2019).

There are several ways of choosing a contractor when considering the bid by the following criteria:

- least cost;
- qualifications only;
- quality and cost based;
- quality based;
- sole source;
- fixed budget (Roseke, 2019).

The most basic and intuitive method is to choose a vendor based on cost alone. This is how most construction and trades are chosen. Using price as the sole selection criterion should be limited to situations where the work is relatively well defined and understood by the contractors. Otherwise, they are likely to inspect the contract documents extremely carefully and ensure that their price addresses the risk of project changes (Roseke, 2019). If the tender process is hasty, it may happen that one gets only one or two offers out of ten.

In the following case, old museum school roof cover needed to be changed. The school was built from logs roughly 120 years ago and the sheet metal covered roof was at the end of its life cycle. The project budget was 120 000 €. The cost of the first offer was 168 000 €, which was far from the estimated cost. The cost of the second offer was 98 000 €, which enabled to proceed with the contract. The whole building had to be covered due to weather conditions and the nature of the project, as shown in Fig. 4.3. Scaffoldings were erected next to the building, and steel trusses + tarpaulins covered the upper part. In this way the old building was safe from rain and sleet. Conditions for roofing were nearly perfect as well.

However, the contractor can be chosen based on their qualifications only, without any consideration of cost. Firstly, the contractors are asked to provide information on their methodology for performing the work, including scheduling and methods for ensuring project safety and quality. Secondly, the

contractors are asked to provide information on their project team, including professional resumes and a listing of relevant work experience. These can be assessed to provide a score for the project team. Information on past projects that the company or project team has performed can provide confidence in the quality of work the contractor will produce. This information can be provided in any format preferred by the contractor if the relevant information is produced. Items like location, cost, size, completion date, duration, and a brief project description can be requested to obtain the context.

Naturally, the price is established prior to performing the work, but it does not factor into the contractor selection. The contractor is selected based on the qualifications and then requested to provide a price after they are informed that they will be performing the work. This is generally limited to small projects, or small portions of larger projects that have a low likelihood of having a significant impact on the project budget. Because it is unknown whether the chosen contractor's price is reasonable relative to the others, it is used where qualifications are worth significantly more than the price.

In fixed budget the owner specifies the price, and the contractor adjusts the scope of work to that. They might remove items that are considered by the



**Fig. 4.3.** Old school roof renovation for weather protection at Padasjoki, 10/2020.

owner to be critical to the project. This method is rarely used, but when we wish to perform whatever work is possible within the budget, it is available as an option. Unlike the other methods, the contractor is writing out the scope of work rather than determining a price. Hence, the document should be reviewed and negotiated to ensure that all stakeholders are clear on what work is included.

#### 4.2.4. Pre-construction

---

The pre-construction phase includes all the activities in a construction project that occur prior to construction. From the moment a project begins to the time you are ready to start construction you are in the pre-construction phase. During the pre-construction phase a strategic plan must be created, a budget and timeline must be agreed upon, a design for the project is begun and finalized, permission is acquired, and procurement of both labour and resources occurs. If the project is complex or rear, it normally means difficulties all the way from the beginning to the end. Berlin-Brandenburg airport recently opened nine years later than originally planned. Construction work of Olkiluoto-3 Nuclear Power station started in 2005 and it has not been finished yet, just to mention a few extreme examples. On the other hand, if everything goes smoothly from the start, the results can also be praised by critics. Travel centre and fuel station at Niemenharju (Fig. 4.4) was selected as the most beautiful fuel station in 2017 by DesignCurial.



**Fig. 4.4.** The most beautiful fuel station of 2017. Glulam and CLT structure. 12/2020.



## 4.3. MANAGEMENT AND LEADERSHIP

There is a significant, yet unclear difference between management and leadership. When discussing these concepts, it is useful to clarify which one is under surveillance. The terms of management and leadership are often used interchangeably. Bennis and Townsend (1995) have written a famous yet controversial quote of the difference: “Leaders are people who do the right things, and managers are people who do things right”. Comparison is straightforward and oversimplistic but gives an idea of the division. Leaders are interested in direction, goals, vision, objectives, intention, effectiveness and purpose, which Bennis calls the right things. Managers are interested in efficiency, i.e. ‘how to’, the short for ‘running of doing things right’. Kotterman (2006) discusses the same distinction in slightly different terms. Both leaders and managers may be involved in establishing direction and motivating people and aligning resources. Managers plan and budget, while leaders set the direction. Managers’ purpose is narrower while they try to stabilize work, maintain order and organize resources. Leaders aim to develop new goals and align organisations. Leaders motivate, while managers control and solve problems.

Whereas the scope of this book is practical, the scope is in management, i.e. what kind of construction processes there are in the field that help to manage the process from order to plan and further to delivery, from an idea of a building to a product ready to be handed over to the user to people to whose purposes the building is made. However, only through recognizing and developing own leadership style it becomes possible to manage the concrete processes efficiently and effectively. Well-functioning leadership, whether namely as position delegated to you or somebody else, is everybody’s responsibility in work community. By respecting values such as good communication and trust and act in manners which promote harmony in the work community, we contribute to good leadership. Shift from old-fashioned leadership structures to new co-operative ways of working does not happen overnight. Bringing different parties into ‘one room’ does not create trust. Different trainings and rewarding policies may function as agents for change. Construction leadership is undergoing a cultural shift from the time of characteristic theories where commands are given hierarchically from top to bottom cannot be ‘sold’ to future generations.

Need for a better dialogue in construction leadership is referred to in many other articles, particularly concerning alliance construction model. Typical features of alliance are shared contract agreement, shared organization, shared risks, trust, commitment and co-operation. The first three are referred to as structural (hard) type features and the last three as co-operative (soft) type features. Soft features are prerequisites for successful processes but difficult to measure (Yli-Viilamo & Petäjaniemi, 2013).

Rottermann et al. (2015) have identified engineering leadership roles in their study in which they have conducted four focus group interviews with engineers to find out how engineers define leadership. They have named their first finding: “Leadership is not us”. This means that leadership altogether was found elitist, imprecise, impractical and simply ‘not us’. There seemed to be cognitive dissonance between engineers’ professional identity and their views of leadership as antithetical in relation to these strongly held identities. Engineers, being applied scientists, found the strategic plans of charismatic visionaries impractical and imprecise. Engineers defined themselves as service professionals. This approach was seen conflicting with the hierarchical notion of traditional leadership. The individual implicit in ‘great man’ theories of leadership contrasts with the ‘day-to-day’ work. Engineers depend on objective and rational data to execute their core task, which is solving technical problems. This is the reason why they felt unprepared to deal with emotionally intense and highly subjective problems. Delegating tasks was an unpleasant task for engineers who identify themselves as ‘doers’. Engineers also felt that the nature of their work has directed them to build iterative processes and leaders as change agents tend to mess this order by restructuring.

Rottermann et al. (2015) found three different dimensions of engineering leadership in their study. Firstly, engineering leadership is about **technical mastery**. Engineers speak with admiration about solving technically challenging problems. Dimensions of mastery include subject-matter expertise, integrated application of scientific and mathematical theory, creative problem-solving peer-recognized expertise, ability to comprehend colleagues’ questions and clarify confusion of others and support growth through formal and informal mentoring systems and confidence in own technical confidence. To conclude, technical mastery integrates elements of mentorship, coaching and communication with high level computational, pattern recognition and creative problem-solving skills.

Secondly, engineering leadership is about **collaborative optimization**. This approach highlights the need for teamwork in engineering profession. No

individual specialist can understand everything about a system, which is why teamwork is an essential part of engineering profession. Dimensions of this theme include optimizing team processes, facilitating independence, motivating and enabling others, balancing quality, building bridges across organizational units, leveraging team members strengths, skilfully assembling interprofessional teams, exhibiting organizational savvy, managing conflict through collegial communication, collective problem solving, shared responsibility, self-organizing systems and establishment of feedback of networks.

The third dimension is **organizational innovation**. This means entrepreneur-like thinking to bring technically and scientifically sound ideas to practice and further on to market. This dimension is property of all included in the work organization and not seen as property of top hierarchy. This includes dimensions such as operationalizing innovative ideas, system planning, establishing organizational culture by example, big picture thinking, problem posing, thinking outside the box, creating a vision, institutionalizing best practices, taking risks, learning from failure, founding start-ups, persuading others to follow, catalysing change, market savvy and identifying opportunities.

## 4.4. SAFETY MANAGEMENT

The construction industry is a challenging sector from the perspective of occupational safety. The work is dynamic and changeable, which makes it different from other sectors. Frequent moves between work sites and the presence of multiple contractors at the same site also make it more challenging to ensure occupational safety. The number of accidents in the construction industry is high because of the constantly changing circumstances, and there are also numerous health hazards, such as chemical exposure in the case of renovation projects. In addition to the risk of occupational accidents construction workers are exposed to, for example, noise, various kinds of dust and changes in temperature and weather conditions (Tyosuojelu.fi., n.d.).

Finnish Government's Decree on the Safety of Construction Work 26.3.2009/205 shares a lot of practical information which is useful to any builder regardless in which country the work is done. The concept of shared construction site means that it is the **developer's** duty to ensure that each of the stages of the build is planned so that the work can be carried out safely and without jeopardizing the health of the workers. The term 'shared workplace' means a workplace where employees of several employers and / or independent contractors are working simultaneously.

Most construction sites have one employer who acts as the project supervisor and therefore has more control and broader responsibilities than the other parties operating on the site, including keeping all other employers, their employees and independent contractors up to date on the hazards and risks associated with the site, the safety instructions and procedures to be followed in respect of firefighting, first aid and evacuation, and the identities of the persons responsible for the above, coordinating the work of the employers and independent contractors operating on the site, organizing access to and from as well as within the site, keeping the site sufficiently neat and tidy to ensure the workers' safety and health, overseeing the general planning of the site, ensuring the overall safety of the working conditions, and familiarizing new workers with the site.

### 4.4.1. Safety Measures

---

**The developer** must outline a safety document listing the hazards and risks involved in the construction project and provide information relevant to occupational safety and health. The developer must also ensure that the safety document is kept up to date as the project progresses. Furthermore, the developer must draw up written safety rules and procedures that consider the nature of the site and explain, among other things, how safety is to be monitored and photo IDs worn on site. Developers' obligations are set out in Sections 5 to 9 of the Government Decree on the Safety of Construction Work (205/2009).

Before the building work begins in a construction project, the **principal contractor** must draw up plans in writing concerning occupational safety and the use of the building site. These plans must then be used to organize the various stages of the building work to make them as safe as possible. It must also be ensured that the work causes no hazards for those working on the building site or anyone else affected by the building work. For instance, any lifting and moving to be done on the building site, whether mechanical or manual, must be planned to avoid accidents and personal injury. The machinery and equipment to be used in the work must be carefully selected.

The **project supervisor's** duties cover the entire subcontracting chain, and the project supervisor is therefore responsible not just for the safety of its own staff but also that of all subcontractors' employees.

Conversely, the other employers and independent contractors on the site must inform the principal employer and other employers of any hazards or risks that their operations may cause on the site. They must also ensure from their part that the work they do will not endanger the safety or health of anyone else working on the same site. In addition to this, each employer must look out for his own employees in accordance with the Occupational Safety and Health Act.

It is the **employer's responsibility** to eliminate or reduce the harmful strain caused by physical work and to ensure that employees' health does not deteriorate at the workplace. Once an assessment of factors that cause strain has been completed, existing risks and hazards are addressed in order of importance. While measures focus primarily on prevention, measures to reduce the seriousness of any effects are also taken. It is important to ensure

that all employees receive appropriate information, instruction and training regarding health and safety at the workplace and that they know how to avoid specific hazards and risks.

Examples of measures:

- planning of work, design of workstations and selection of tools to reduce physical strain and improve the efficiency of work;
- development of working methods and tools to support ergonomic work;
- planning of work in such a way that employees do not work in poor positions for long periods or repeatedly by, for example, setting up breaks or cycling employees between different tasks;
- instructing employees on safe and healthy working methods and monitoring adherence to the instructions;
- acquisition of required assistive devices to lighten the strain caused by the work and the instruction of employees in their use; discussions with employees and their representatives regarding possible problems and solutions;
- improving the organization of work and psychosocial environment at workplace and promoting musculoskeletal health;
- any preventative measures also need to consider any technical changes to devices, the digitization of the work process and changes in the organization of work (26.3.2009/205).

## 4.5. QUALITY MANAGEMENT

---

**Quality control** in construction typically involves insuring compliance with minimum standards of material and workmanship in order to insure the performance of the facility according to the design.

All contractors at site should control their own work quality, but commonly most of them do not have a robust quality management process in place. In many cases, their written program is somewhat general. Traditionally, the project supervisor is responsible for the quality of the work. The supervisor depends on the different craft workers to follow normal and customary industry practice when it comes to the quality of the work. Such a process depends a lot on the ability, knowledge, judgment and diligence of workers, and the supervisor's persistent and careful control.

In this kind of management system there are many factors that come into play, which must be managed well to ensure that the subsequent quality of the work will meet expectations. The team must be qualified, so keeping qualified workers on the payroll is essential. Also, managing the worker workloads as well as the hiring practices is important. General contractor has to ensure that the supervisor has enough time to oversee the work quality and manage it effectively. Having management oversight of the quality process will ensure that standards are met. To some extent, this is how many of the construction companies try to ensure the achievement of contract quality requirements.

A more structured approach is to draft a quality management program and create a quality management process: instruct supervision on the process, implement a control system and hold people specifically accountable for their tasks. Every work performance and results should be reviewed. Continuously improve the process where possible. Following is a framework for a sample quality management process that may become the basis for managing quality of the project delivery process at a construction company (Furst, 2015).

Failure to meet project quality requirements can have several negative implications on the project delivery process. Quality failure creates extra work for the parties involved but has the greatest impact on the contractor. It negatively influences the designer and the owner as well. It can damage business relationships and possibly lead to time-consuming and costly legal action for contractors.



In research study conducted in 2015 in Finland by Sami Kirjalainen, the findings revealed that in the production of residential buildings in the target company defects happen periodically in irregular situations, and they cause significant cost effects (Kirjalainen, 2015). The causes of these defects are the habit and the way the job is done. It seems that the causes of defects are originating from the common culture of construction. To eliminate the causes, the company should concentrate on improving the knowledge of the management team and the constructability of designs already at the initial design stage. The research shows that in the worst case the defects during construction phase can decrease the contractor's margin even by 10 percent.

## 4.6. PRINCIPLES OF MAKING CONSTRUCTION SCHEDULE

---

Construction projects are particularly difficult, and they are known for encountering delays as mentioned before. Construction site is a combination of lot of moving parts, teams, contracts, designers, equipment and materials. In addition, the weather is not always favourable for builders.

Tools that are rooted in construction project management software, such as Gantt charts and resource management, are key features to control the many phases of construction. Still, they just support the process. The construction schedule is the pillar of any successful project management for construction.

It is true that different levels of construction schedules are time consuming. You need to take all the steps, avoid shortcuts and work towards creating the most accurate schedule you can. The more time you put into the construction schedule, the less issues you will have when you execute the plan, which is key to good construction project management (Weber, 2020).

**Three most important steps in a functioning construction schedule are as follows.**

### 1. Get necessary information and tools

---

Begin by listing all the subcontractors involved in the project. Once you have completed the list, reach out to them to make sure their timing is the same as yours. Once you have that information, ask how long different phases of the project are estimated to take. This is key for accurate time estimation on your part.

You will also need to make sure that the plans are complying with the local codes. Get the list of requirements and what inspections will be needed throughout the process. This is normally part of the starting meeting with local authorities. Code restrictions vary depending on the type of construction and materials you will be using. The main designer should do the research to make sure your project is compliant.

Use the project management tool that suits your needs. There are templates and charts that can help you get started if you do not want to build your plan and schedule from scratch. There is several different project management software to make your schedule look professional. However, it is more important for you to know how long different tasks will take using different methods or teams.

## 2. Prioritize Tasks

---

After having the context and tools, you need to break your project down into the tasks that will lead it from schedule to wanted results. You need a truthful schedule listing every task that must be performed to have a successful construction.

One can use a work breakdown structure (WBS) to get a handle on the size and scope of the project. You can think of this tool to visualize your deliverables by starting with whatever you are going to construct and then breaking it down level by level until you are at the most basic parts.

At this point it is useful to gather the necessary input from your teams and subcontractors that you are going to employ. The more thorough your task list is, the more accurate your schedule will be. Missing tasks are what can ruin your project, so keep your mind on scope. Remember that some tasks are dependent on others, so you must link those. It is quite challenging to build the roof before external walls.

After you have written down your task list, you will need to put those tasks in the right order. Also use the information from your team and not count only on theoretical figures. You can also use Gantt chart software to spread these tasks over a project timeline.

In the beginning your tasks might be small, which helps you to break larger tasks down into controllable smaller pieces. It also helps to break up the whole project into larger phases or milestones. A milestone in the construction project is a point that marks the end of some large phase, for example completion of foundation works.

### 3. Duration

---

Depending on how long-term the project is, you will need to calculate into your schedule public holidays and consider sick and vacation days for employees. If there are other seasonally related or personal issues that might come up, be sure to use them as a ruler when measuring your schedule's duration. The tasks are given starting days and completion days. These determinations must be realistic. Construction site is affected by climate, but weather forecasts are not precise, especially long-term. Therefore, find out historical data about the weather to get an estimation of how the climate might impact the work. The closer to arctic circle we work, the more wintertime construction varies from that in Mediterranean climate.

This means that you have more thinking to do on working with subcontractors and suppliers. The project details are outlined in your contract, but usually those dates are subject to change. This means that your schedule needs to have allocation for instabilities.

Theoretical time schedule to complete any given task is important and should lead your planning. Still, make the schedule realistic! Be honest with yourself and give everything enough time in your schedule to be completed properly. Bear in mind also a non-task related scheduling, such as procurement, delivery and other issues that are crucial to the project. You need to have a clear picture of what you are receiving, when the material or service is arriving and how you will handle the delivery. Inspections, necessary tests and in the end handover to the happy client.

## REFERENCES

- Bennis, W., & Townsend, R. (1995). *Reinventing leadership*. London: Piatkus.
- Designing Buildings Wiki. (n. d.). *Feasibility studies for construction projects*. [https://www.designingbuildings.co.uk/wiki/Feasibility\\_studies\\_for\\_construction\\_projects](https://www.designingbuildings.co.uk/wiki/Feasibility_studies_for_construction_projects)
- Finnish Governments Decree on the safety of construction work 26.3.2009/205.
- Furst, P. (2015). *Construction quality management*. <https://www.irmi.com/articles/expert-commentary/construction-quality-management>
- Hendrickson, C. (2008). *Project management for construction*. Department of Civil and Environmental Engineering, Carnegie Mellon University.
- Kirjalainen, S. (2015). *In the production phase observed defects and their costs in residential building projects*. Aalto University. <https://aaltodoc.aalto.fi/handle/123456789/19254>
- Kotterman, J. (2006). Leadership versus management: what's the difference? *The Journal for Quality and Participation*, 29(2), 13–17.
- Roseke, B. (2019). *Contractor selection methods*. <https://www.projectengineer.net/contractor-selection-methods>
- Rottermann, C., Sacks, R., & Reeve, D. (2015). Engineering leadership: Grounding leadership theory in engineers' professional identities. *Leadership*, 11(3), 351–373.
- Tyosuojelu.fi. (n.d.). *Construction industry*. <https://www.tyosuojelu.fi/web/en/working-conditions/construction-industry>
- Weber, J. L. (2020). *How to make a construction schedule*. <https://www.projectmanager.com/blog/make-a-construction-schedule>
- Yli-Viilamo, H., & Petäjäniemi, P. (2013). *Allianssimalli. Rakentajain kalenteri*. Rakennustietosäätiö RTS. Rakennustieto Oy.



# Chapter 5

## Construction Process

### 5.1. Typical Wooden Construction Solutions

*Petri Lento*

### 5.2. Quality Assurance

*Petri Lento*

### 5.3. Construction Process Management Guide

*Per Sorensen*

### 5.4. Process Management in Timber Construction

*Petri Lento*

## APPENDIXES

## References



## 5.1. TYPICAL WOODEN CONSTRUCTION SOLUTIONS

**Petri Lento,**

Häme University of Applied Sciences

Various systems for timber construction differ from each other. When looking at the two most used prefabricated element solutions used in more than two-storey wooden apartment buildings in Finland, we have:

- large timber frame elements (traditional from 1990...);
- and solid massive wood space elements (increasing trend from about 2015...).

We can find two very different kinds of approach in construction process. Main differences of these two systems are presented in Table 5.1.

Timber frame element is considered to be cost effective in lower, maximum four storey buildings, and in additional floor construction due to easy weather protection and lightness. Also, a building contractor whose business is based on traditional assembly methods on building site can easily adopt timber frame elements construction system. Timber frame elements has been a traditional method of building one to two storey private and detached houses since 1950s.

Mr. Kilpeläinen and others stated already 20 years ago that cost savings in construction are achieved due to shorter on-site phase and effective production conditions at nearby sources. Manufacturing elements at a plant is faster, and available labour resource is closer to raw materials and assembly site. Raw material use is more controlled in industrial conditions, and raw material waste is less. Material flow and work can be organised at the location where it is most affordable (Kilpeläinen et al., 2001).



Table 5.1

## Different Approaches in Construction Process

Large timber frame elements	Space element with massive wood
Customer decision for architecture – more freedom for building layout and appearance	Customer decision for architecture is more limited (i.e. suitable for standard size smaller apartments, for example student houses) and schematic appearance
Design process is more traditional for prefabricated building process, design for prefabricated individual units for production is typically factory made	Detailed design readiness for complete apartment manufacturing early in process, longer design time
Logistics easy, light elements easy to handle on site	More challenging transport and logistics on site
Faster production time, longer site assembly time	Longer manufacturing time, short site assembly time
Tent or other weather shelter required on site	Typically, weather protection included in each unit
Faster than concrete, slower than space element	From foundations ready to move in fast
Finishing quality management on building site	Finishing quality management focus on production line
After elements assembly on site, all highly industrialized element products are finished on site – 10-year guarantee from the main contractor, typically, 2-year guarantee for large timber elements from the supplier.	After elements assembly on site, all highly industrialized element products are finished on site – 10-year guarantee from the main contractor, 10-year guarantee from the space elements supplier (typically, the main contractor)
Easy to renovate or even change some elements	Space modifications are not possible

## 5.2. QUALITY ASSURANCE

***Petri Lento,***

Häme University of Applied Sciences

Wood is an anisotropic substance, that means, its moisture life in different directions is different. In the longitudinal direction of the wood moisture content is small, but in the transverse direction the moisture content is larger. If wood is dried from totally wet to absolute dry, the tree shrinks tangentially about 8 %, in the radial direction about 4 % and in the direction of the causes about 0.4 % (Puuinfo Oy, 2020).

Changes caused by the moisture life of the wood must be taken into account in construction. For example, in log construction the drying causes the frame to pile up. In addition, drying causes pressure inside the wood that can cause more cracking to wood construction. The wood usually cracks at the point where the distance is shortest from the surface (Puuinfo Oy, 2016).

Trend on the construction market is to increase prefabrication and production of wood-based buildings. Target is also to speed up building works and move more work to be done in factories. One major advantage for industrial prefabrication is the diminishing importance of the seasons in year-around construction. Also, smoother quality is expected when educated workforce are working under steady conditions and quality monitoring is in place. Prefabrication brings along better work safety and schedule management. Project management and delivery chain management is more controlled and accurate. On site works are turning more into building assembly tasks.

In construction the quality of prefabricated industrial elements is exceptionally good. This is because elements are produced in exactly controlled conditions. Therefore, the dimensional accuracy is excellent and material losses and mistakes can be minimized in industrial conditions. This speeds up the construction process itself. Realizing the dry chain when elements are under production in a dry indoor environment has clear advantage compared with on-site construction. Wooden prefabricated units are light to transport, and logistics to the site and on site is effective and clean compared to some other materials. During site assembly of elements using tent above the construction gives opportunity to maintain the dry chain until the roof, and building envelope is completed. In the Nordic climate conditions maintaining dry



← “The Gipson tower” is a steady rising weather shelter lift by motors. Assembly crane operates above the building under the shelter. Photo: Rakennusliike Reponen Oy, 2016.

→ Additional floors construction, 7th and 8th floor, Tampere, 2018. Photo: P. Lento 2018.



← This project was a six-storey prefabricated large timber element project for housing fairs in Vantaa, Kivistö 2016. Total floor area of the project was more than 10 000 sqm. including about 200 apartments. The project was built by Rakennusliike Reponen Oy. Photo: Rakennusliike Reponen Oy, 2016.

→ Two more floors of wooden large elements were installed under the tent for a 100 years old downtown block in Tampere. Photo: P. Lento, 2018.



← Mansikkala School, the largest wooden school centre in Finland, Imatra 16 000 sqm, build in 2018–2020. Client: City of Imatra; Frame structure: Glued Timber by Versowood; Facades are large timber elements with massive panels and glued timber columns by Oiva Wood Oy; Roof elements: Oiva Wood Oy; Main Contractor: YIT Construction; Wood structure installation: Kymeenlaakson Rakennus Oy. Photo: Oiva Wood Solutions Oy, 2019.

→ Prefabricated wall, partition floor and roof elements installation inside the frame of one of the seven Mansikkala building blocks. Roof elements consisted of three separate units. Assembly works for one building block took about 4–6 weeks. Facade is coated with ‘rautavihtrilli’ ageing liquid at sawmill. This natural coating turns grey in few months under natural weather conditions. This natural ‘ageing’ keeps facades service proof for ages. Photo: Oiva Wood Solutions Oy, 2020.



Fig. 5.1. Dry chain construction under the tent (Saari, 2019).

chain in construction is essential. For the customer prefabricated wood construction allows for speed and building quality. In Fig. 5.1 there are examples of dry chain construction under the tent.

Wood building materials and elements must be weather protected as long they are installed in place. In storage, transport, and site logistics phase prefabricated wood products are covered with plastic packing. During storing air circulation must be ensured inside the transport packing. When storing packages outdoors, there shall be about 0.5-meter ventilated distance to the moist ground.

Assembly on site takes place under weather shelter until the building has water cover. Space elements are normally water protected at factory. Site assembly must be organised under good installation conditions. In some projects movable roof pieces (roof elements) are used as on-off principle. In such cases moisture penetration into structures is unlikely. Some additional costs, like tent or shelter rent, exist due to weather protection. Weather shelter would be a good quality assurance for the whole construction no matter what kind of building materials are used.

Construction quality is mainly up to the competence and attitude of the working group, site management and quality assurance procedures of manufacturing and assembling company. Factory selection, quality monitoring and LEAN kind of process management provides quality products. When the overall process is under control at the factory and on site, the entire production chain is proper, and project end result will be superb.

## 5.3. CONSTRUCTION PROCESS MANAGEMENT GUIDE

---

**Per Sorensen,**

VIA University College

It is absolutely vital for a good project process to get things start right by making the right decisions in the initial phases of the construction project. It is important to reflect upon the building process and carry out the right activities to increase the chances of success for the project participants and for the project as a whole.

This is about creating clarity about the tasks and interfaces for everyone in the project. From the very start there should be a clearly defined and effective organisation, so the right skills come into play at the right time. The project constraints should be well-known and balanced, so that everyone is familiar with the relevant assumptions and agreements. A clear framework and agreements provide the best foundation for good communication between the parties of the project and form the basis for an effective building process.

This chapter is based on the Danish guide prepared by the project called “Value-creating Construction Process” (Værdibyg, 2020). This guide focuses on the crucial parameters that need to be understood before the project design work starts. The specific tools and methods in the guide will help the project to get things right from the start and provide for a value-creating project process right through to handover.

### 5.3.1. Key principles

---

#### About the guide

---

The guide describes the key activities that the client organisation and the project design team need to manage proactively to provide for an effective building process.

The activities fall under three headings:

- Create clarity about the task and the process.
- Balance the project constraints.
- Bring the right skills into action.

Across these areas there is a general need for communication. Effective communication is a crucial parameter for the success of a construction project.

## **When and for whom?**

---

The recommendations in the guide are aimed at the initial phases of the building process when the client has just identified the partners who are to handle the project design (and possibly also the subsequent construction). Before this, a process has taken place in which the client's ideas were discussed and clarified to provide a basis for the subsequent project design. Now it is about getting the project right from the start and laying the foundation for a value-creating building process going forward.

The target group for this guide therefore encompasses the client organisation, the consultants and the contractors who are involved early in medium-sized or large construction projects.

## **Checklist and toolbox**

---

The guide ends with a checklist which the client and the team can use to ensure that they have covered all the key topics. There is also an appendix with specific tools for inspiration and practical use. We refer to these tools throughout the guide.

## **Communication – the key to the right start**

---

Communication is a fundamental factor in a good building process, so it is crucial to make it clear from the start: how are we going to communicate? The client and the team should agree on a set of common ground rules for

communication in order to ensure that nothing gets lost ‘between the lines’ and that there is room for the necessary questions to be asked and answered.

This can be set out in a communication plan which is an overall script for the communication work through the building process – note the example in Appendix 5.1.

Preparing for the communication will provide the client organisation with a number of basic rules for how things should be communicated during the project. This plan is then converted into a document applicable in discussions with partners and providing a common understanding of how both internal and external communication should be handled in the actual project.

## **Internal and external communication**

---

The client and the team should communicate internally to ensure clear areas of responsibility and interfaces and constant progress in the project. Procedures and guidelines should be drawn up and complied with, preventing the project from being flooded with unstructured information, which could give rise to misunderstandings and inefficiency. It is important that the project information is accessible, readable and up to date. There should be a clear strategy governing how things are to be communicated to whom, and how often. This is particularly important in relation to external communication concerning project progress to the public, the local area, future users, existing residents, etc. The communication plan should also address more mundane subjects such as the meeting structure, the ‘tone’ of the meetings, use of e-mails and other digital media, etc. It is important to agree on common ground rules and constantly evaluate and modify them as the project evolves.

## **Stakeholders and politics**

---

A good basis for producing a communication plan is a stakeholder analysis identifying the stakeholder groups involved in the project. It is important to proactively identify the key stakeholders and interests and to pin down the areas where, e.g. political decisions could affect the progress of the project.



## ICT

---

ICT (Information and Communications Technology) plays an important role for communication in a project team. The use of ICT offers great potential for knowledge-sharing across functions, which can provide for an optimisation of the project. But this requires that information and drawings are structured in order to prevent misunderstandings and duplication. It is important for everyone to use software systems that are compatible with each other for a fluent exchange of information and data. A project website is also a useful platform for exchanging files.

The ICT guidelines must not be decoupled from the rest of the process; rather, they should help to support the overall goals of the project throughout the process. The ICT guidelines will often be produced by specialists, but it is important for the ICT specifications to be written in a straightforward language and for the guidelines to be communicated and handed over to all new actors in the project.

It may help to look up the Danish BIPS directions for ICT specifications or the FRI and DANSKE ARK's supplement to the Service Specifications for handling ICT in the building project (A building component description is defined by BIPS and described in Danish publication B100, where BIPS stands for: Construction Information Technology Productivity Cooperation).

## Disseminate the communication plan

---

It is essential that the communication plan is disseminated, and that management actively supports the implementation of the desired communication culture in the project. The communication plan will typically be part of an overall project plan or project handbook.

## Create clarity

---

Before a building project gets properly started, all parties should be clear about the following issues:

- What are we building and why?
- What are the client's needs and wishes, and how should they be satisfied?
- How does the organisation appear?
- What should the process be like?

## Clear values produce the right solutions

---

The client and the team should start by aligning their expectations, perceptions, and ideas about the forthcoming project, so work can continue on the right solutions to the right needs. The client organisation itself may be a complex entity made up of builders, lawyers, politicians, users, finance people, operators, etc., so clarifying needs and values is a process that demands some effort.

The design specification should contain the project's underlying visions, needs and values as well as the assumptions and requirements established in the early phases. The design specification alone cannot support knowledge-sharing from planning through to project design. The needs and values of the client organisation and the specified task should be compared with the conception of the job by the project team.

## Value tree

---

To ensure that the values are adhered to throughout the project, a value tree can be used. The value tree is a discussion tool to establish coherence between the vision and more concrete criteria for the project design. It acts as a proactive compass and allows for the subsequent design process to be monitored and evaluated in a measurable way (Fig. 5.2).

The value tree should be completed jointly by the client and the team to arrive at a shared understanding of the fundamental values behind the project. It is important to give everyone a hearing and to challenge needs and solutions with the specific knowledge possessed by each member of the team. It is furthermore important for the value tree to reflect a series of measurable success criteria which the team can then incorporate in the project design process. The client kicks off with his needs and wishes, and then the team describes in specific and measurable ways its intentions of meeting these.

The value tree is thereby a discussion tool offering answers to how the overall vision and goals should be addressed as well as to why the chosen solutions are appropriate. A detailed value tree can be seen in Appendix 5.2.

It is essential to remember that the building process is a learning process, and that it may be necessary to modify the value tree along the way. The value tree thus becomes a dynamic tool that can be changed and expanded as further and more detailed decisions are taken.

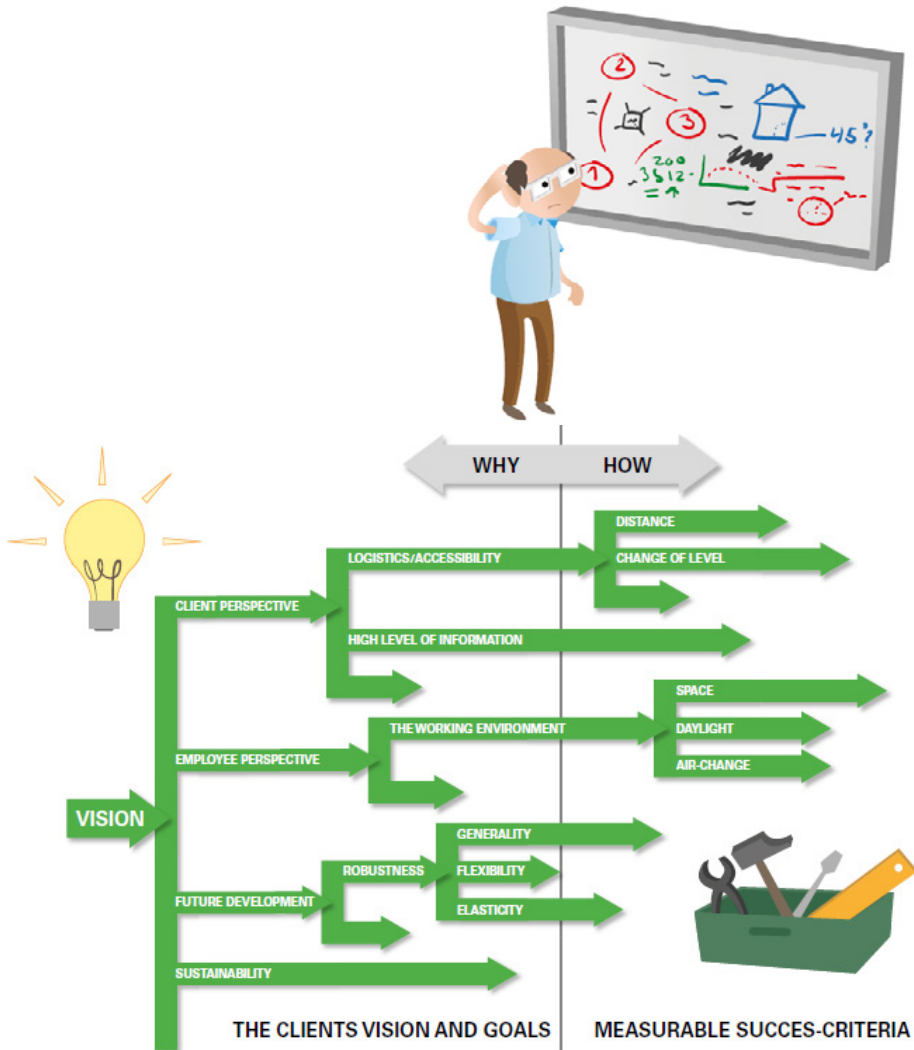


Fig. 5.2. The value tree (Værdibyg, 2020).

## Routes towards a common understanding

---

There are many useful activities for the team and the client to undertake to ensure a common understanding of the content and scope of the assignment and of the needs of the client or future users:

- Study visits to completed or ongoing reference projects will give the team a better understanding of the client's wishes and may inspire thinking along new lines.
- Studies of the end-user's day-to-day behaviour and culture will enable the consultants to understand and challenge the specified needs.

## Example of user studies

---

*In connection with the expansion of Copenhagen University's Department of Veterinary Clinical and Animal Sciences, the consultants visited the vets, doctors and nurses at the existing hospital. The workflows that they observed made the consultants better qualified to draw up and propose suitable solutions for the extension of the hospital, including operating theatres, recovery, admissions, reception, etc.*

- 1:1 mock-ups, which involve building a prototype of parts of the building (e.g. a bedroom or a flat), will stimulate practical dialogue between the team and the client. They also allow users, operation staff, contractors, etc. to get a better idea of the end-result and to uncover possible errors and problems.
- Scenario-building provides different views of directions, such as market changes, lifestyle trends and climate change, in which the context surrounding the building can evolve. It allows the team and the client to discuss needs and values in a longer-term perspective – what do we want for the future?

## Organisation and Process

---

Apart from creating clarity about the needs and how they are to be met, it is important to be clear about the organisation of the project and the coming

process – who does what, and when?

A number of good tools are available for this:

- **Organisation chart**

A graphical depiction of the contractual relationships and of the decision and communication paths in the joint project organisation.

- **Service specification**

The client's description of the consultant's role and services.

- **Interface form**

Schematic overview of activities at the interfaces between the individual actors.

- **Terms of reference**

Description of roles, responsibilities, and decision-making authorities of various sub-groups (e.g. steering group, advisory group, project management, etc.).

- **Project plan**

Overall description of organisational and management structures and procedures.

- **Diagrams**

The placing of roles and responsibilities should be communicated clearly and precisely to the client organisation and the team. A sensible method is to distinguish between the following diagrams:

- Contract organisation – who has a contract with whom?
- Decision-making organisation – who can decide on what?
- Communication chart – what paths do we use to communicate?

Example diagrams can be found in Appendix 5.3.

We recommend that the organisation is simplified as far as possible to provide for a more straightforward decision-making process and to make it easier for everyone to understand the organisation and act in accordance with the specified structure.

The communication chart can be supplemented with more details via sheets

with the project participants' photo, contact details and principal function (e.g. ICT manager, project design manager, technical manager, etc.).

## Terms of reference

---

The project organisation chart may be supplemented with terms of reference for horizontal sub-groups (e.g. steering group, user group, project management, advisory group, etc.). The terms of reference describe the tasks to be performed by the different project units and the constraints within which they can act. An example table of contents for terms of reference for user involvement is given in Appendix 5.4.

The terms of reference should be communicated widely across the project organisation, so that all parties involved know what functions and tasks each sub-group has, who has the authority to make decisions, and hence what each of them can expect from the others.

## Services and interfaces

---

When producing the contract documentation, the client should be very precise about the services expected of the team. We recommend expanding on FRI and DANSKE ARK's specifications of services by adding an extra column containing additions and exceptions to the standard specifications. This will provide recognizability and also allow the specifications to be adapted to the project in hand. For example, see Appendix 5.5.

The problems often arise at the interfaces between the services of the different actors. Building installations are particularly prone to interface problems when, e.g. ventilation, heating and electrical installations are integrated into an overall automated control system for the indoor climate in the building (see also an example relating to doors). In these cases it is useful to produce an interface diagram; an example can be found in Appendix 5.6.

## **Example of services and interfaces around doors**

---

*There are many issues to be considered when designing doors:*

- **Functionality**

*General design, illumination and visibility, flow, automatic opening and closing.*

- **Structures**

*Structural coherency and dimensioning of walls and floor.*

- **Fire**

*Location of fire doors, automatic closing.*

- **Risk of theft / access control**

*Locking systems, security doors.*

- **Electricity**

*Coherence between electrical components and general electrical supply to the building, monitoring and control. This area contains interfaces among the architect, fire engineer, security engineer and the overall electrical project. There may also be specific acoustic factors to consider requiring consultation with suppliers, carpenters, security and electrical contractors.*

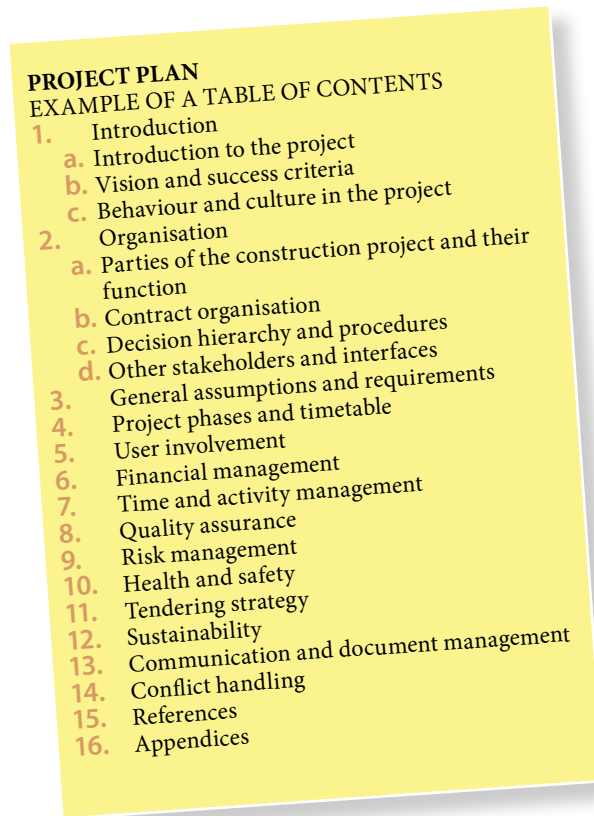
*A door project often involves coordination among 8-10 different actors. It may give rise to serious problems if all the requirements for collaboration are not in place.*

### **5.3.2. Project Plan**

---

To provide an overview of the project organization and process, a project plan (Fig 5.3) should be produced. The project plan works as a handbook to the project and contains not just an overview of the various structures and procedures in the project but also an overall description of the project process right through to operation. The project plan unites the guidelines, diagrams, terms of reference, etc. It may also include a timetable and descriptions of procedures, for example for project economy, time and quality management, including critical milestones and risk management.





**PROJECT PLAN**  
**EXAMPLE OF A TABLE OF CONTENTS**

1. Introduction
  - a. Introduction to the project
  - b. Vision and success criteria
  - c. Behaviour and culture in the project
2. Organisation
  - a. Parties of the construction project and their function
  - b. Contract organisation
  - c. Decision hierarchy and procedures
  - d. Other stakeholders and interfaces
3. General assumptions and requirements
4. Project phases and timetable
5. User involvement
6. Financial management
7. Time and activity management
8. Quality assurance
9. Risk management
10. Health and safety
11. Tendering strategy
12. Sustainability
13. Communication and document management
14. Conflict handling
15. References
16. Appendices

Fig. 5.3. The project plan (Værdibyg, 2020).

The project plan should give the team and the client organization a clear answer to how the process is to be implemented. It is a dynamic tool to be used and modified throughout the process. The individual elements of the project plan must work together, so that, e.g. the results of the stakeholder analysis are reflected in the interface charts, the communication plan, the organization chart, etc.

Preparation of the project plan should involve the parties who are to apply it. This will ensure that all parties know in advance how the project is going to be constructed. The process of creating the project plan is thereby another activity which provides for collaboration and coordination across the disciplines involved in the project.

The project plan should be concise but it should also contain the essential details of the project. When the project plan is handed over to new actors in

the project, there should always be an oral presentation and discussion of the content.

### 5.3.3. Balance of the Framework Conditions

---

Framework conditions set the boundaries for the task and are defined by the client and the surrounding community. Such boundaries to a building project may be legislation (e.g. governmental regulations for public buildings), municipal planning issues, the governing overall budget, geotechnical factors and deadlines.

#### Crucial balance

---

Balanced framework conditions are a fundamental requirement for a good project. With an agreed balance between the task, the desired quality, time, budget and risk, the building project can be implemented to the satisfaction of all parties. Good contracts produce a win-win situation for all parties, balancing roles and responsibilities. The balanced framework conditions and agreed expectations should be reflected in both the overall contracts and in the behaviour of the project participants and the management approach to the project. On this basis, the team and the client will be better equipped to handle the challenges that emerge in the course of the project.

#### Alignment of expectations and collaboration

---

Early in the process the client and the team should each clarify what they expect of the proposed project. It is important to be honest about the parties' different goals and to recognize that all parties have a good case in order for the project to become a success. The entire project team – including the client – must collaborate and be prepared to help each other if any party unintentionally gets into difficulties. And this, in turn, places demands on the underlying contract documentation, where early involvement and incentive structures can help to reinforce the parties' interest in achieving a common goal. It is a good idea to kick off the collaboration between the team and the

client organization with a start-up workshop, focusing among other things on the expectations of the project content and the process protocol. At the start-up workshop, the participants should draw up a joint declaration of intent describing the ground rules for collaboration in the project. The declaration of intent is not a legal document, but it represents ground rules for the process and can later be used as a basis for the regular evaluation of the collaboration.

## Handling project changes

There may be many reasons why changes are required in the project along the way during design and production: new users may introduce new requirements; market developments may change the preconditions for the project, etc. With one-off buildings it is hard to predict time and budget and thus to achieve a balance between framework conditions. In these cases there will often be a need to make continuous adjustments to the project. Project changes are often a source of frustration for both the client and the project team and can cause conflicts and delays in the process.

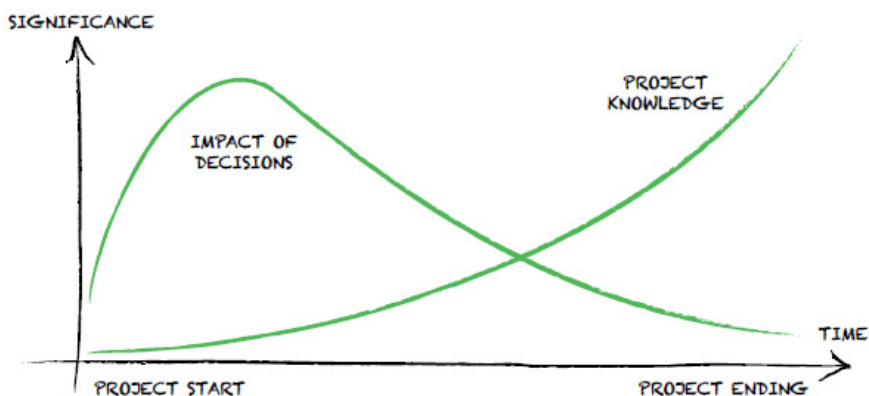


Fig. 5.4. The project paradox (Værdibyg, 2020).

## The project paradox

---

The reason why it may be necessary to make changes to the project can be found in the 'project paradox'. When the project starts, we know very little about it but, paradoxically enough, this is when the most important decisions must be taken (Fig. 5.4). Many of the assumptions made at the beginning may turn out not to hold water. So, we must make continuous changes and adjustments, even if this calls for greater coordination and re-planning.

## Tools for handling changes

---

Not all the suggested changes have to be implemented. It is important to thoroughly consider whether a change proposal is worth the necessary effort. When a change to the project is decided, there are various tools available to maintain a balance between the framework conditions:

- **Frequent estimates**

In projects with fixed budgets, it may be recommended to make frequent estimates of the overall costs of the project. In this connection the design should be constantly adjusted to the finances (and not the other way round) in order not to re-start the budgeting process. Estimates may be made, for example, by successive calculation (see, e.g. Steen Lichtenberg: Project planning in a changing world), which is a tool for risk management and cost estimation.

- **Decision process**

When there is a need for changes, it is important for the client organization to be geared for quick decision-making. Long drawn-out decision-making can kill any progress and cause both the budget and the schedule to slip. A decision plan should be drawn up in which the delivery team, the project management and the client commit themselves to deadlines with a process for efficient decision-making.

- **Flexibility**

A possible strategy is to work on a basic design with various additional options, so everything does not need to be re-designed if the budget comes under pressure.

Changes may lead to a slipping schedule, and extending the construction period will often entail substantial costs. Furthermore, handling ongoing changes to the content of the project is a demanding process. In this regard, it is crucial for clients to communicate how they prioritize time, cost, and quality, so any change is not made at random but according to a deliberate, structured, and well-considered process.

### 5.3.4. The Right Skills

---

A good project is heavily dependent on the right skills coming into play at the right time and being utilized in the most advantageous way. Continuity, relationships, skills, and leadership are keywords in this regard.

#### **Permanent actors**

---

In the transition from planning to project design it is important to ensure that there are a few permanent people who can carry forward the original ideas and visions, and that new actors are integrated as quickly as possible to maintain efficient teamwork. This process can be encouraged by assembling the project group so that relationships can be established – e.g. via workshops, kick-off seminars or team building events. Likewise, it is important that the appropriate skills are brought into play at the right time. Many architects' firms are very aware, for example, that it is mainly creative people who should be deployed at the start of projects, with more production-oriented staff joining in later in the process.

#### **Start slow and build relationships**

---

A project team will not perform 100 % from day one. To begin with, a new project team member will focus on finding his or her own place in the project and on forming an overview of relationships and roles, rather than focusing on the assignment. Many new actors may cause a temporary drop in efficiency. This represents another good reason for creating clarity around roles and services early in the process.

Building relationships through social events provides the benefit of creating better communication between the parties. It is simpler to call or write to someone if you have met one another. It is important to create a sense of confidence in the project group, so everyone dares to ask so-called 'stupid' questions and enter a discussion.

## Make space for the skills

---

The right skills should not merely be in place at the right time; they should also have the time and space to develop. It is undesirable for the project manager to become absorbed in technical details, or for the architect to be spending all his time managing budgets. So, it is essential to create a structure in the project to allow all of the actors to do what they are best at.

### CHECKLIST

This sums up the good advice given in the preceding sections. The checklist is intended as a tool for the client organisation to ensure that all the necessary aspects have been considered.

- ✓ How are we to communicate, and with whom – both internally and externally?
- ✓ Is the communication plan clear and comprehensible to all?
- ✓ Are the values and visions for the project clearly conveyed for the users?
- ✓ Have activities been planned to provide for a common understanding of the assignment?
- ✓ Have the framework conditions been identified and communicated?
- ✓ Have the organisation, terms of reference and interfaces been defined?
- ✓ Have the process and the schedule been formulated?
- ✓ How is the follow-up on the process and the handling of changes ensured?
- ✓ Who possesses the right skills?
- ✓ Are the skills supported and brought into play at the right time?

Fig. 5.5. Checklist (Værdibyg, 2020).

## Chairing meetings

---

Bringing the right skills into play requires an overview from the people managing and coordinating the project. When it comes to solving a specific problem, a good project manager will be aware that the important skills may be 'hidden' in people who perhaps are not so dominant in meetings. So, good management is often a matter of chairing good meetings and getting everyone take an active part where it adds value.

In larger workshops you can make use of an external facilitator who has not only general knowledge of building projects but also special expertise in group dynamics.

An external facilitator can more easily create a space in which it is permitted to ask the difficult questions which the project participants cannot or dare not ask. A 'speak your mind' culture should be established early in the project, making it OK to question the project and the decisions that have been taken (Fig. 5.5). See Appendix 5.7 for good tips on chairing meetings.

## 5.4. PROCESS MANAGEMENT IN TIMBER CONSTRUCTION

**Petri Lento,**

Häme University of Applied Sciences

Chapter 5.1 describes the different methods and systems how to build from wood. It also introduces the most common wooden building materials and solutions that are used in factory assembly and on-site installation of prefabricated wooden elements. Some combined building solutions, so-called Hybrid solutions, are also presented as modern, more sustainable methods to build. To understand the entire wood construction process, one must be aware of the variations and solutions introduced in Chapter 5.1. In addition, Chapter 5.2 “Quality assurance” gives more aspects to pay attention to when any wood construction process is managed.

Chapter 5.3.2 introduces a collection of the latest thinking of Finnish wood construction segment entrepreneurs regarding use of wood in construction. This thinking includes ideas which are presented in the Finnish “RT Puutoteollisuuden kehitysryhmä” (Construction industry / “RT Finnish wood products industry development group”) in recent years. The undersigned has been a member of this development group since 2016 (Rakennusteollisuus, 2020; Puutuoteollisuus, 2020).

The ideas about the process are also collected from the recent study published by the Ministry of Economic Affairs and Employment of Finland on 25 June 2020. The title of publication is “An overview of industrial wood construction – wood elements”. The review examines the wood element industry, which offers solutions for large-scale constructions such as apartment buildings and public sector. There are about 30 companies in the sector, many of them are small and medium-sized enterprises established in the 2010s. The survey contains interviews with more than 10 entrepreneurs (Sipiläinen, 2020).

Wood construction process management has the following specific needs, least but not limited to (Sipiläinen, 2020):

- *Reasonable legislation*, norms and municipal planning for wooden construction realization.



- Wood construction segment's *readiness and capacity* to operate competitively.
- Wood specific resources training and constant research and development.
- Customer support and technical awareness for elimination of prejudices.
- Customer training and procurement know-how to build wooden constructions (CO<sub>2</sub>, etc.).
- Utilizing co-operation networks for complete wood construction value chain management.
- *Design know-how and capacity*, detailed 3D libraries for wooden construction solutions.
- *Project management* skills (new kind of value chain responsibility).
- Prefabrication and logistics, the *dry chain management*.
- *Quality assurance* during guarantee period.
- *Use and maintenance*, service manual and maintenance handbook.
- End of life cycle and *recycling*.

The process follows topics from 1–12 related to the wood construction process management scheme and it sums up some ideas about the society and industry approach to wood construction process and thinking in the value chain in 2020.

### 5.4.1. Reasonable legislation, norms and municipal planning for wooden construction realization

---

Wood construction in Finland was the most common form of building for a long time, but its popularity began to decrease in the 1950s. Some interest in modern wood construction arose again only in the 1990s when the Finnish government started activities in wood construction research & study to promote wood construction projects and new techniques. In 2010, emphasis on ecology of construction and life-cycle thinking promote the use of wood. New changes in building regulations came into force. Modern wood construction has increased remarkably after 2011. Many large wooden buildings have been built. Recently there are several intentions to develop norms for more favourable usage of wood in construction. Application of the EN Eurocodes regarding the design of load-bearing structures requires the establishment of national annexes.

Current worldwide sustainability thinking and CO<sub>2</sub> targets for societies operate as drivers for advanced legislation and norms. In Finland, most of municipalities and cities take wood construction into account in municipal planning. The targets set for public sector construction and the carbon footprint review regulation that will come into force by 2025. That will fuel the demand for wood construction in the domestic market. Similarly, the general attitude is also favourable for industrial wood construction.

The four main principles of climate-sustainable zoning are (Ymparisto.fi., 2020):

- Minimizing the use of natural resources.
- Enabling a sustainable lifestyle.
- Minimizing consumption emissions.
- Preparing for the risks of climate change.

### 5.4.2. Wood construction segment's readiness and capacity to operate competitively

---

Global competition is growing in the wood construction sector: in 2019, for the first time ever, the value of wood houses imported to Finland exceeded the value of exports. Industrial wood construction has great potential to grow in Finland in the near future and in export markets in the longer term. To efficiently support the use of wood in residential building and public sector construction, it is essential to pay attention to the business environment and the ability of the sector's companies to make a profit (Sipiläinen, 2020). The target of the entire construction market is to find more cost effective, fast and sustainable solutions for building. There is a tendency to transfer more and more assembly works to industrial manufacturing and under controlled dry conditions. Building sites have had to learn new kinds of installation methods and practices.

In recent years wood is considered to be equal to any other building material. Wood construction becomes more competitive after the field of competition is properly created, legislation is revised and the methods of construction and designing are unified. The greatest possibilities to increase wood usage in construction lie in the construction of blocks of flats (Sipiläinen, 2020).

### 5.4.3. Wood specific resources training and constant research and development

---

Educational institutions and construction industry organizations have begun to arrange education and training of resources. There is especially big demand for wood construction designers and site foremen. Nowadays several institutions develop specific learning content and plan wood-specific education. Industry organizations lobby for legislative matters. Research and development take place in many organisations, and plants are in search for more competitive and technically better solutions. Some of the research and development is supported by the state financing in search for sustainable solutions.

Some contractors have been developing, working and learning their own wood building concept in order to become forerunners on the market. For some companies making wood buildings is already a normal practice. Such companies have the best knowledge of the cost level and practice. It has been said that wood construction is more expensive than any other traditional building method. On the other hand, recently there have been a few articles which state that a normal cost level has been met. This shows that different construction systems are coming closer to each other in technical properties and cost wise. Still, there is some argument, especially in the freely funded market, about the cost of wooden constructions (Sipiläinen, 2020).

Other companies participate in contract competitions and make their first attempts to make a proper wood house. Obviously, only by making new kind of solutions one can learn. The same goes with wooden buildings installation. So far in Finland about 70 % of realized wooden apartment houses are three to four floors high. Such projects are not too big to jump in. The current trend is to build apartment houses by using a space element technique either with massive wood frame or timber frame. Another commonly used technique is to erect wooden houses by using large timber frame elements under the tent (Sipiläinen, 2020).

#### 5.4.4. Customer support and technical awareness for elimination of prejudices

---

When asking for the arguments in favour of wood construction, the issues of ecology of the wood and green value come up. These are important for municipal builders and especially for big construction companies. Responsibility in construction business is a big deal. Ecological solutions, CO<sub>2</sub> neutrality and other sustainable issues are nowadays every responsible company's strategic key words. Sales of wood construction solutions utilize these modern time arguments. During the building process, real cost saving advantage comes from the speed of assembly and effectiveness of prefabrication. Customers are different. For example, student foundations are big builders and they have become forerunners in Finland with standardised high wood construction projects made of space elements. Student foundations appreciate green values and they have found a reasonable cost solution to fulfil their housing needs (Sipiläinen, 2020).

Green values demand will continue to increase in the future when legislation will focus more on life-cycle analysis and carbon footprint. Especially in municipal projects like schools, kindergartens and health care buildings good indoor air quality is given a special attention. The wish for having a wooden apartment building or a healthy indoor school building seems to be major mind-opening for many municipal decision-makers towards sustainability in municipal construction.

#### 5.4.5. Customer training and procurement know-how to build wooden constructions (CO<sub>2</sub>, etc.)

---

The argument that can make it easier to procure a wooden building is that many manufacturers and turn key contractors can offer the whole concept of realization. Wood or any material itself shall not be the main argument. Public tender can ask for a total solution for the requested criteria. Or it may be, for example, a negotiation competition where bidders may propose variations for open technical tender specification. Negotiation procedure is an excellent opportunity to learn when several candidates present their best solutions and values. Naturally, for many negotiations as such more time is

needed. Still, the learning aspect is remarkable. Let us not consider wood as a material but enabler.

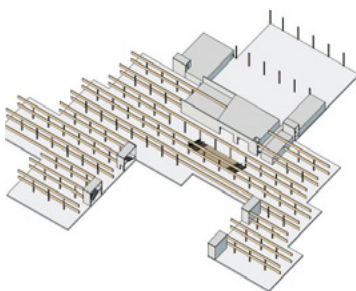
Successful have been those cases where customer, architect, contractor and wood construction manufacturer sit down together early enough to fix the best possible realization variant. A good example of this was the Mansikkala School Centre project in the city of Imatra, Finland. This project got honourable mention in the yearly “Wood construction” prize 2020 (Fig. 5.6).

#### 5.4.6. Utilizing co-operation networks for complete wood construction value chain management

---

For builders and construction companies the key question is to find reliable partners for the wood construction project. Each company has developed their own strengths and can manage processes by usual methods. New kind of materials and building solutions require new kind of operations and process management. There are new tendencies regarding the building site management and leadership (Sipiläinen, 2020).

New partners and processes must fit to the new kind of production strategy. Some contractors already have their own production premises, others are planning big investments for having capacity and adapting their own style of production. Project by project new alliances occur and subcontractor networks are developing. This gives opportunities for entrepreneurs to start new business and develop new strategies (Sipiläinen, 2020).



Mansikkala School Centre frame layout,  
16 000 sqm



Photograph: Oiva wood Solutions Ltd, 2020

**Fig. 5.6.** Mansikkala School Centre project.

### 5.4.7. Design know-how and capacity, detailed 3D libraries for wooden construction solutions

---

At the moment wooden structures design takes more time than the traditional concrete or steel design. This is due to still under development normative base for new wooden solutions for bigger construction. It is also obvious that there are many wooden design standards due to several different wood construction materials, systems and prefabrication practices. On the other hand, there is advantage during construction because of typically shorter building time on site.

For the market we need more experienced designers who can make detailed drawings also for various wooden solutions. It is also essential that industry develops their own standards and detailed libraries for anyone's use. In modern 3D design, it is crucial for the whole wooden building segment to have all the necessary data for general use. Designers, component suppliers and manufacturers shall not keep their secrets hidden. It will not develop the branch. Having proper design on time with standardised solutions can bring remarkable cost savings for wood construction (Sipiläinen, 2020).

### 5.4.8. Project management skills (new kind of value chain responsibility)

---

Many contractors have not yet joined the wooden construction scheme. One reason for this is the attitude: why change something that works? Business volume in wood construction is still smaller compared to some other more used building systems. That is why some well-established companies have not accepted the new variant so actively yet. Learning something new is not yet topical in strategy. If business is good, some companies may wait for more standardisation and experiences by the others before rushing into the genre. Anyway, it is obvious that all construction companies are following modern trends, and little by little they must form their approach to new ways of building. A well-considered process and new kind of project management skills may be the drivers for a new strategy (Sipiläinen, 2020).

There already are construction companies which have specialised in wood construction alongside with other solutions. Such companies are now

forerunners of the segment. Recently also the biggest companies in construction have expressed their interest in wood construction. Technically there is no big difference in project management, no matter which construction technique is utilized (Sipiläinen, 2020).

#### **5.4.9. Prefabrication and logistics, the dry chain management**

---

This topic is quite thoroughly described in Chapter 5.1 “Materials and Solutions” and Chapter 5.2 “Dry Chain Management”. Prefabricated solutions and new building materials each have their own specialities. On the other hand, there is nothing too exceptional for any company to handle. In most of the cases material supplier or manufacturer is able to give the necessary information and handbooks and show how to manage. Most factories have their own technical department for clients’ service.

#### **5.4.10. Quality assurance during guarantee period**

---

Guarantees in wood construction are typically the same as in any construction. There have been some hesitations earlier, for example, concerning facade coating service period. The contract-based responsibility for main contractors is 10 years. There were expectations that the main contractor’s responsibility was to repaint the building during the guarantee period. The present experience shows that wooden buildings and their facades from ten years ago have proved to be durable and solid through the guarantee period. Normal maintenance is needed as in any building. Maintenance shall be done according to information in the service manual.

One of the forerunners in wooden construction has followed user satisfaction in wooden house. A practical follow up has shown that during the guarantee period there have been fewer reclamations in wooden house than in concrete projects listed in the database of the same company. It is obvious that managing dry-chain during construction and having accurate dimensions in element production keep the guarantee defects at minimum.

It has also been measured that acoustic properties of a wooden building

differ from those of a concrete building. In real life some residents sense that the sound atmosphere is more pleasant in a wooden house, on the other hand, some residents appreciate the sound of the concrete building. In 2017, Professor Markku Karjalainen published a resident satisfaction study in wooden apartments after minimum two years of living. The survey's general result is a summary of 302 answers from 17 buildings, which is as follows: in wooden apartment "there were less annoying noises", "acoustics properties were pleasant", "comfort and beauty values were good", and "there was a warm feeling in the apartments". The feedback also summarises that more visible wood surface was on the residents wish list (Karjalainen, 2017).

#### **5.4.11. Use and maintenance, service manual and maintenance book**

---

When a new building is handed over, the contractor hands out a service manual to the housing company. The service manual is a guidebook for the building maintenance and service company. It includes instructions on the products and materials used in the building, maintenance instructions, description of repair methods, replacement of changeable parts, standard use of energy and water. In some cases consultants can prepare a more exact and long-term maintenance book for the needs of predicting coming renovations (Sipiläinen, 2020).

#### **5.4.12. End of life cycle and recycling**

---

After years to come and when a building's life-cycle is coming to the end, the following actions will follow: demolition of the building, waste handling and transport, material disposal, possible reuse of materials, recycling and energy recovery. There are still no final formulas for calculating the CO<sub>2</sub> and other recycling values, but indications already exist and it is clear that some building materials are more sustainable than other. The most essential thing on the whole is – which set of values will count.



## APPENDIXES

---

One may retrieve appendixes from <https://vaerdibyg.dk/>

The Value Creating Building Process (VÆRDIBYG) is a partnership between seven most influential organisations in the building industry. VÆRDIBYG is developing a new best practice for the construction process covering the different actors in the industry. The guide discusses the activities meant to ensure that a construction project and a project team get things right early in the process laying the foundations for the subsequent process to become value-creating.

## APPENDIX 5.1

---

### DRAFT COMMUNICATION PLAN

---

Example of contents of a communication plan:

#### **1. COMMUNICATION AND DECISION PATHS**

Key people for the project

Telephone and e-mail details for all

‘Who knows what?’ form

#### **2. INTERNAL COMMUNICATION (IN THE PROJECT TEAM)**

#### **3. RULES FOR COMMUNICATION VIA**

Meetings

E-mail

Project web

ICT

Formal and informal

Handling disagreements

Speak your mind and question the assumptions

#### **4. EXTERNAL COMMUNICATION (TO THE OUTSIDE WORLD)**

Organisation and procedures

Stakeholders and target groups

Channels

Media management

#### **5. FOLLOW-UP**

Meetings focusing on communication

Success criteria, evaluation and measurement

## APPENDIX 5.2

### VALUE TREE

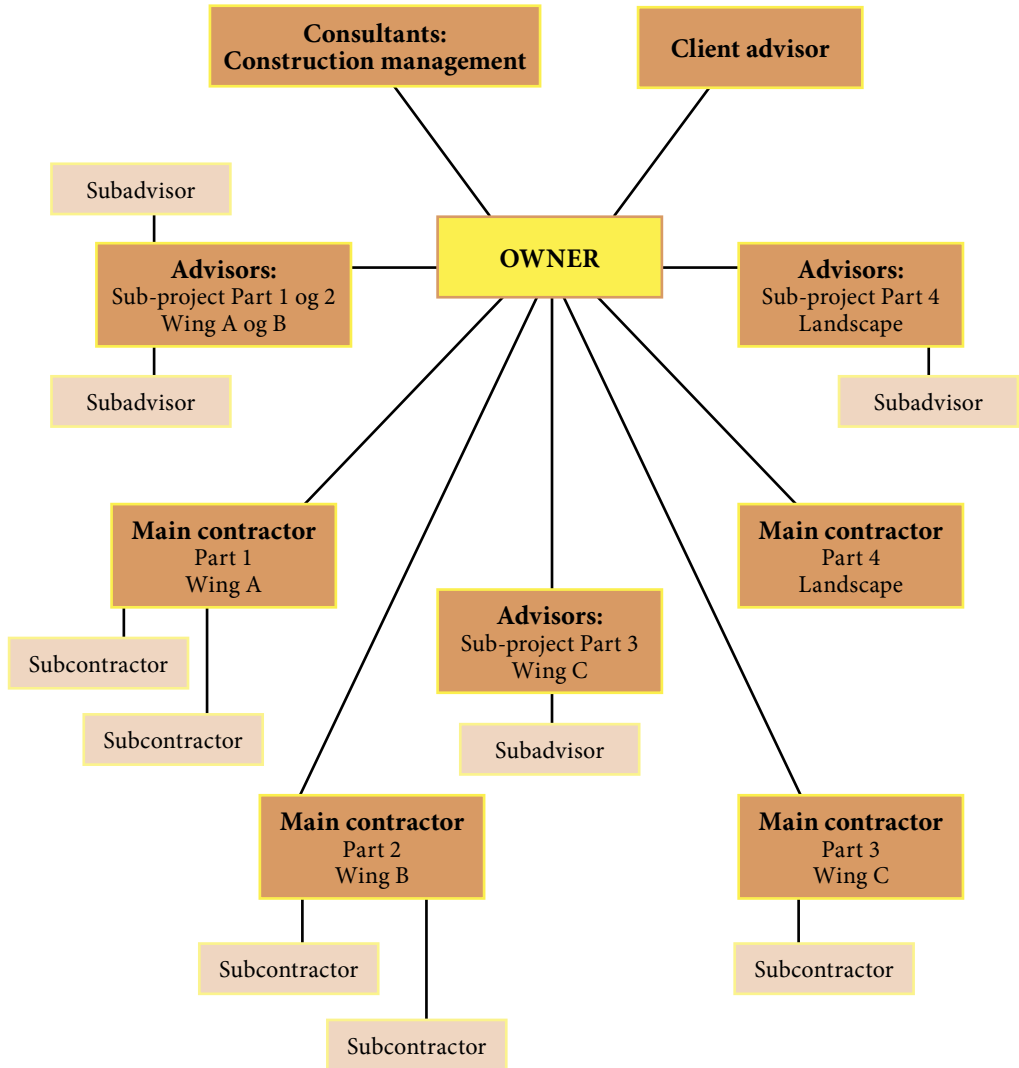
The example is from the Teleparken project, a public housing project in Gladsaxe. Read more about the project on [www.jonsson.dk](http://www.jonsson.dk)

Parties involved: Domus Arkitekter (Architect), Jönsson (Contractor), Niras (Process Consultant), FSB (Client), Grontmij (Engineer), Lassen Landskab (Landscape Architect)

Basic value	Level 1 Why?	Level 2 How?	Comments
Beauty	Shape	Interplay with the other buildings	The architectural motif should be consistent
		Consistency in the garden	
	Expression	Simplicity 'inspired' by the works of Kaj Fisker	Representing some limitations
		View of facades around e.g. balconies, entrances, etc.	
		Interplay between facade colours – 'the white city'	
Materials	Robustness and consistency		
Light	Lights is important – play and quantity		
	Illumination in flats		
Environmental impact	Other	Low emission targets are linked to low operating costs	Planning authority is contacted for instructions
		No basement, to avoid dealing with contaminated soil	
	Consumption	Low consumption targets linked to low operating costs, including: <ul style="list-style-type: none"> <li>● Good waste management</li> <li>● Rainwater collection</li> <li>● Low energy consumption <ul style="list-style-type: none"> <li>• Recovery in ventilation system</li> <li>• Visible monitors (to encourage savings)</li> </ul> </li> </ul>	
	Other	Use of suppliers operating with environmental management systems	
Buildability	Systems and deliverables	Prefab. bathroom modules	Should be considered in light of quality and fitting
		Concrete elements	Avoid odd shapes to minimise on-site casting
	Functional installation of ducts		
	Buildable balconies/optional system?	Should living rooms have balconies or be replaced by access to garden?	
	Execution	Focus on a best practise installation process	
Simple solutions and well-matched materials			
Aim at zero-soil groundwork accounts to minimise contamination problems			

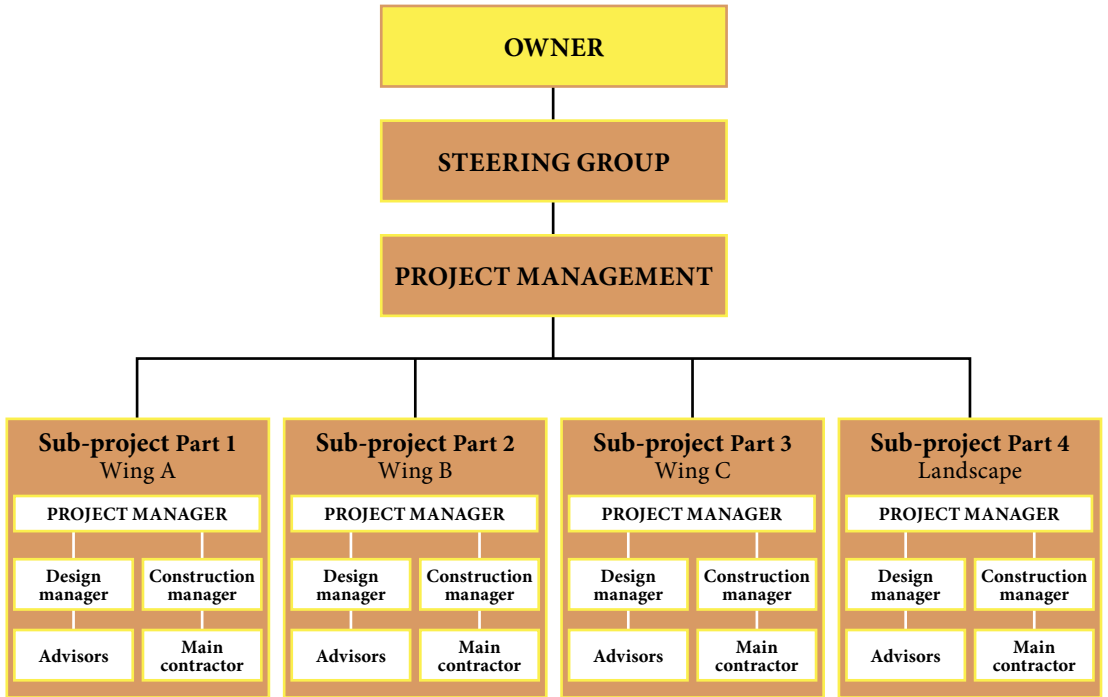
## APPENDIX 5.3

### ORGANISATION CHARTS CONTRACT ORGANISATION

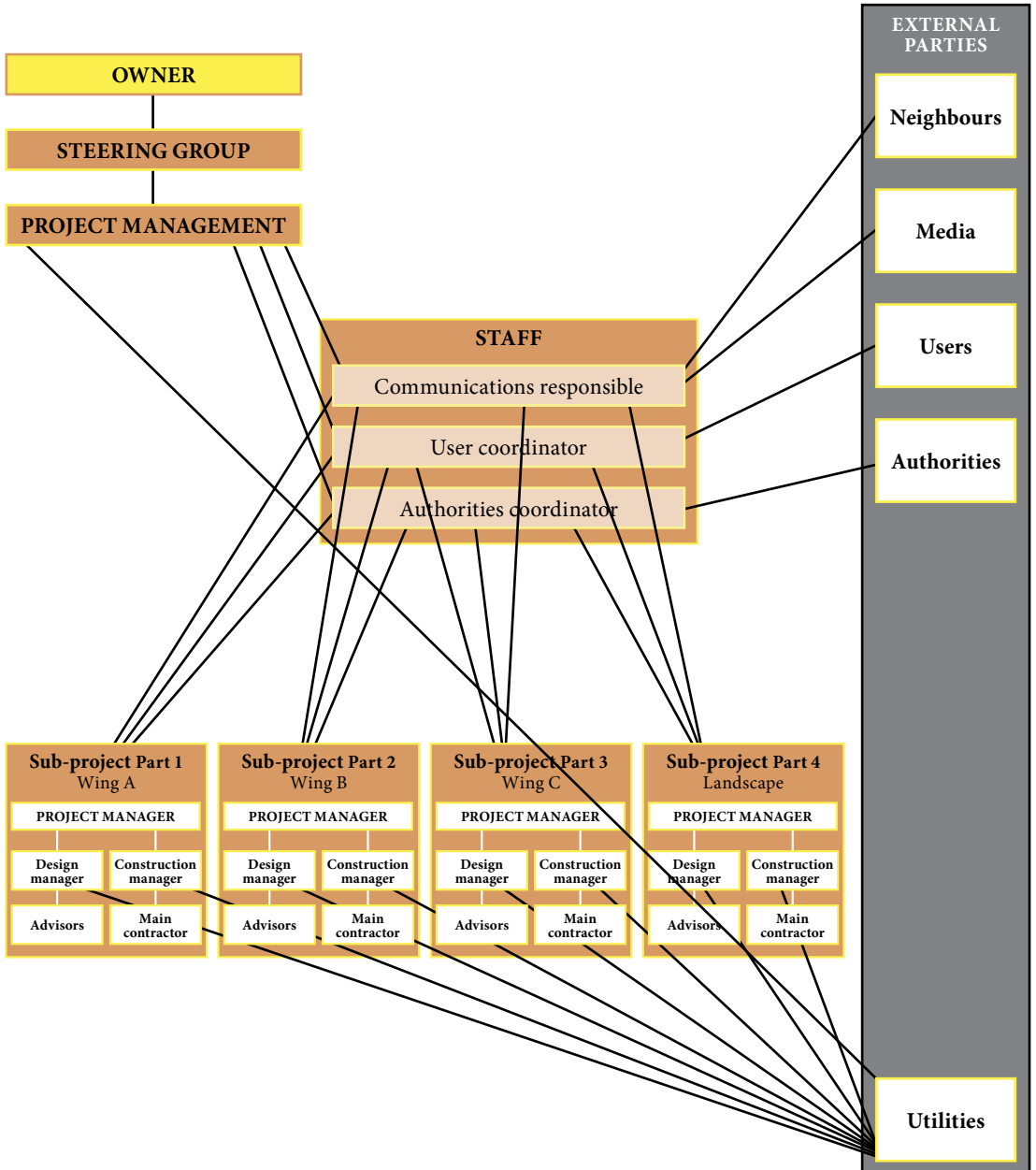


## DECISION-MAKING ORGANISATION

---



# COMMUNICATION CHART (FOR EXTERNAL PARTIES)



## APPENDIX 5.4

### TERMS OF REFERENCE FOR USER INVOLVEMENT

Example of a table of contents for user terms of reference:

#### **1. PURPOSE OF USER INVOLVEMENT**

#### **2. SUCCESS CRITERIA**

#### **3. ORGANISATION**

Organisation and decision plan for user involvement

#### **4. ROLES AND RESPONSIBILITIES**

Political

Administrative

External consultants

User groups

Authorities

#### **5. DESCRIPTION OF GROUPS AND TASKS**

User groups in general

Handling feedback

Total-consultant

User steering group and consultative group

Departmental groups

Interdisciplinary subject-groups

Other stakeholders

#### **6. THE PHASES**

Start of process

Design specification phase

Outline proposal

Project proposal

Pilot project – authority project

Main project

Commissioning

#### **7. PROCESS TO DATE**

#### **8. TIMETABLE**

#### **9. DOCUMENT OVERVIEW AND LINKS**

## APPENDIX 5.5

### SERVICE DESCRIPTION

Extract from a service specification based on FRI and DANSKE ARK's Service Specifications (left-hand column). The right-hand columns contains the client's additions and comments for the consultant.

From the service specifications	Contents		Relevant additions/ comments
	Yes	No	
<p><b>3.2.6 Quality assurance</b> The consultant reviews the project proposal to ensure:</p> <ul style="list-style-type: none"> <li>• that the project proposal is consistent with what was determined in the outline proposal,</li> <li>• that the requirements in the design specification for the overall quality of the building (form, function, construction technology) and for costs and time have been met,</li> <li>• that the project proposal can act as a basis for preparing the pre-project and the main project.</li> </ul> <p>The consultant informs the client of any special or risk aspects found in the review. The consultant takes part in an interdisciplinary project review</p>	×		Quality assurance is carried out in accordance with the agreed quality assurance manual.
<p><b>3.2.7 The client</b> While the project proposal is being produced, the client – and/or their appointed user representatives – should attend the necessary meetings on, e.g. detailed room layout, fittings etc. The client approves the governing budget and updates his own budget related to other expenses. The client approves the project proposal as the basis for further project design work.</p>	×		The total-consultant provides an overview of the necessary meetings with the client and his user representatives for approval by the client up front. After 'updates', is inserted 'after input from the consultant'.
<p><b>3.3 Pilot project (authority project)</b> The pre-project (authority project) is a further revision of the approved project proposal to the point where it can serve as a basis for official approval. The pre-project (authority project) is an integral part of the main project.</p>	×		



## APPENDIX 5.6

### INTERFACE FORMS EXTRACT FROM INTERFACE CHECKLIST

× indicates who bears the responsibility, while O indicates further professional influence in the area.

Interface checklist (extract)											
	Client	Client consultant	Turnkey contractor	Architect	Geotechnical engineer	Sound consultant	Engineer Structure	Engineer HVAC	Engineer Electrician	Landscapist architect	Interface agreed
...											
<b>6. The building – Primary building components</b>											
A Design principles			O	O							×
B Loading requirements			O								×
C Objectives, overall and detailed geometry			O	×					O		
D Tolerances (e.g. camber, temperature changes)			O								×
E Expansion joints			O								×
F Anchoring of roof			O	O							×
G Steel reinforcement in outside walls			O								×
H Window openings, stairs, risers, etc.			O	O							×
I Installation bushings			O	O						×	
J Thermal insulation			O	O							×
K Vapour barrier, poss. ventilation of structures			O	O							×
L Soundproofing			O	O							×
M Airtightness											×
N Installation bushings, light walls			O	O							×
<b>7. The building – For Completion</b>											
Building components											
A Opening skylights, smoke release dampers			O	×							O
B Sun screening			O	×							O
C Window glass types			O	O							×
D Suspended ceilings			O	×		O					
E Inspection hatches			O	O							×
F Fresh air vents in windows and facade			O	O							×
...											

## EXTRACT FROM INTERFACE CHECKLIST

Subject	Consultants, contractors or sub-projects responsible for project design		
	Sub-project 1	Sub-project 2	Sub-project 3
Installations			
Ring main for water (underground)	×		
Branch pipes (underground)	×	×	×
Main distribution panel			×
...			
Connection between wings			
Concrete walls in module line C		×	×
Doors in module line C			×
Electrical installations (fire, security and supply) for doors in module line C			×
...			
Movable inventory	×		
Cross-disciplinary environmental coordination		×	
Signage – indoors		×	
Signage – outdoors			×
...			

## APPENDIX 5.7

---

### SERVICE DESCRIPTION – 10 PIECES OF GOOD ADVICE FOR CHAIRING MEETINGS

---

#### 1. THINK ABOUT THE NUMBER OF PARTICIPANTS

Effective working groups should not exceed 15 people.

#### 2. CONSIDER MEETING FACILITIES

Participants should all be able to make eye contact, the indoor climate should be OK and distracting elements (sound, light, etc.) avoided.

#### 3. THE PURPOSE AND FRAMEWORK FOR THE MEETING SHOULD BE IN PLACE

Communicate the purpose (well ahead of the meeting), draw up a clear agenda, define and stick to the time frame.

#### 4. BE PREPARED AND ARRIVE ON TIME

Insist that the participants do the same.

#### 5. PROVIDE FOR BREAKS

... if the meeting goes on for a longer time. This will provide fresh energy, and informal chats in the breaks may open up for important questions which would otherwise not have been asked in the formal forum.

#### 6. REMEMBER TO SUM UP DISCUSSIONS AS YOU GO ALONG

Close the meeting by gathering action points (remember to include this as an agenda item).

#### 7. PAY ATTENTION TO ESOTERIC TALK

and technical terms. Ask clarifying questions.

**8. RESTRICT DOMINANT PARTICIPANTS**

and bring in those who are hanging back. Ask for comments from the whole group.

**9. REMEMBER TO EVALUATE MEETINGS**

that repeat over a longer period to improve them.

**10. PRODUCE AND DISTRIBUTE THE MINUTES**

in good time before the next meeting

## REFERENCES

---

Karjalainen, M. (2017). *Results of the 2017 survey of wood apartment building residents and builders.*

Kilpeläinen, M., Ukonmaanaho, A., & Kivimäki, M. (2001). *Avoin puurakennusjärjestelmä: Elementtirakenteet.* Vammala: Wood Focus Oy.

Puuinfo Oy. (2016). *Lujuusteknisiä ominaisuuksia.*  
<http://www.puuinfo.fi/puutieto/puu-materiaalina>

Puuinfo Oy. (2020). *Puuproffia.* <https://puuinfo.fi/>

Puutuoteteollisuus. (2020). <https://puutuoteteollisuus.fi/>

Rakennusteollisuus. (2020). <https://www.rakennusteollisuus.fi/>

Saari, H. (2019). *Presentation in Puupäivä “wood days”.* Rakennusliike Reponen Oy.

Sipiläinen, I. (2020). *An overview of industrial wood construction – wood elements.* Description sheet Published by Ministry of Economic Affairs and Employment of Finland 25 June 2020.

*Værdiskabende Byggeproces.* (2020). <https://vaerdibyg.dk/>

Ymparisto.fi. (2020). <https://www.ymparisto.fi/fi>



# Chapter 6

## Use and Maintenance

### **6.1. Fundamentals of Building Use and Maintenance**

*Ineta Geipele, Maris Kalinka, Janis Zvirgzdins*

### **6.2. Use of Digital Technologies in Real Estate Management**

*Maris Kalinka, Ineta Geipele, Janis Zvirgzdins*

### **6.3. Data Base for Management Purposes**

*Maris Kalinka, Ineta Geipele, Janis Zvirgzdins*

### **6.4. Maintenance Management Plan**

*Maris Kalinka, Ineta Geipele, Janis Zvirgzdins*

### **6.5. Maintenance and Repair Works**

*Laura Tupenaite, Mindaugas Krutinis*

### **6.6. Failures of Wooden Buildings and Preventive Actions**

*Laura Tupenaite, Mindaugas Krutinis*

### **References**



## 6.1. FUNDAMENTALS OF BUILDING USE AND MAINTENANCE

### ***Ineta Geipele,***

Institute of the Civil Engineering and Real Estate Economics,  
Riga Technical University

### ***Maris Kalinka,***

Institute of the Civil Engineering and Real Estate Economics,  
Riga Technical University

### ***Janis Zvirgzdins,***

Institute of the Civil Engineering and Real Estate Economics,  
Riga Technical University

This chapter includes six parts:

- 1) Fundamentals of building use and maintenance;
- 2) Use of digital technologies in real estate management;
- 3) Data base for management purposes;
- 4) Maintenance management plan;
- 5) Maintenance and repair work;
- 6) Failure analysis.

The first part gives the insight on fundamentals of building use and maintenance. “Digital solutions” shows how to use digital technologies for collecting geometrical information, climate information, researching of wood constructions and managing the collected data. “Data base for management purposes” shows what is database and how to start using the database for building maintenance to use attribute and geospatial information. “Maintenance management plan” gives general information on maintenance of wooden public buildings in three main views: climate, fire treatment and researching for pests and construction stability.

Every building and structure, including public wooden buildings, must be provided with its **management**, **maintenance** and **administration** in order to achieve the following **goals**:

- 1) to ensure the operation and maintenance of buildings and structures (physical preservation throughout their life cycle) in accordance with the requirements of the regulatory enactments of each country;
- 2) to promote the improvement of buildings and structures throughout their operation;
- 3) to ensure the continuity of the management process of each building and structure;
- 4) to preserve and develop the aesthetic values of buildings and structures as environmental objects and, consequently, also the aesthetic values of the respective environment;
- 5) to prevent risks related to public and environmental safety during the operation of buildings and structures;
- 6) to improve the qualification of persons involved in the management of buildings and structures in order to improve the organisation and efficiency of management work.

The handbook sets out principles for the management of buildings and structures, interrelationships, rights, obligations and responsibilities of those involved in the management of buildings and structures, as well as the competences of countries and municipalities in this area. The issues addressed in the handbook apply to the management of all buildings and structures, regardless of who owns the building and structure, except for the individual cases described in the book.

The **management principles** of buildings and structures are as follows:

- 1) continuity of management process ensures the preservation of the use properties (quality) of buildings and structures throughout their life cycle;
- 2) selection of the most optimal possible management work methods, including the formation of optimal management expenses of buildings and structures, comparing them with the solvency of the owner of the building and structure;
- 3) the content and quality of the provided services ensure the preservation of the use characteristics (quality) of the managed buildings and structures throughout their operation;
- 4) inadmissibility of an infringement of the safety or health of an individual in the management process;
- 5) ensuring the preservation and improvement of the quality of the environment in the management process.



Management of buildings and structures includes:

- 1) mandatory management activities;
- 2) other management activities.

The mandatory management activities are as follows:

- 1) maintenance (physical preservation) of buildings and structures in accordance with the requirements of regulatory enactments specified in each country, which includes:
  - a) sanitation of buildings and structures;
  - b) supply of heat, including natural gas, provision of water and sewerage services, disposal of municipal waste by concluding an appropriate agreement with the service provider;
  - c) supply of electricity to the part of the buildings and structures jointly owned (including the operation of the jointly owned facilities);
  - d) inspection, maintenance and repair of buildings and structures, as well as their equipment and engineering facilities;
  - e) ensuring the fulfilment of the requirements set for buildings and structures as an environmental object;
  - f) ensuring compliance with minimum energy performance requirements for buildings and structures;
- 2) planning, organisation and supervision of management work, including:
  - a) drawing up a management work plan which includes a plan of maintenance measures;
  - b) drawing up the draft budget for the year in question;
  - c) organisation of financial accounting;
- 3) management of building and structure cases;
- 4) conclusion of an agreement regarding the use of the attached land plot with the owner of the land plot (in accordance with the legislation of the relevant country);
- 5) provision of information to state and municipal institutions.

### **Maintenance of buildings and structures: sanitary maintenance of buildings and structures**

---

The manager of buildings and structures must ensure compliance with the sanitary maintenance requirements at the site in order to prevent the occurrence of danger.

**Maintenance of the territory of buildings and structures (land belonging to buildings and structures or the attached land plot)**

Territory cleaning shall be performed in accordance with the procedures specified in the binding regulations of the relevant municipality of each country.

Regular cleaning works of the territory:

- 1) cleaning of sidewalks, paths and driveways;
- 2) mowing of the grass growing in the territory;
- 3) collection of fallen leaves, dead plants and branches;
- 4) care of greenery.

During the winter period additional regular cleaning works of the territory should be done:

- 1) cleaning of sidewalks, paths and driveways, if necessary, cleaning also other parts of the territory from snow and ice, spreading anti-slip materials on sidewalks, paths and driveways;
- 2) removal of snow and ice (including icicles) from the facade and roof of the building in order to prevent ice and snow from falling from the roof of the building, cornices, water drains, loggias and balconies;
- 3) demarcation of dangerous places for the safety of pedestrians and vehicles; measures to prevent the risk must be taken in good time, using all possible safety measures.

In the territory of buildings and structures, including the common areas of the facility, various environmental pollutants, waste and construction debris that pose a risk of poisoning, injuries and infectious diseases or are related to the spread of odours shall be removed in a timely manner. Other necessary measures must be taken in good time to prevent the reproduction and spread of rodents and insects.

Waste management shall be performed in accordance with the regulatory enactments of each country regulating the field of waste management. Waste containers must not be placed under the outdoor air intakes of the ventilation system. It is recommended to place waste containers not closer than 10 metres from the windows of buildings.

If there is a dry toilet, a sewage storage tank or an individual sewage treatment plant in the building, the manager of the residential building is obliged to monitor their condition, ensuring the maintenance of structures

in appropriate technical condition and timely removal of necessary tanks to sewage treatment plants.

Rainwater gutters, drainpipes and drainage wells must be cleaned regularly.

The cleaning equipment of buildings and structures as well as disinfectants shall be stored in a specially designed closed place. The manager of buildings and structures shall provide a person who performs sanitary maintenance in a residential building with a water intake.

### **Maintenance of common areas of buildings**

The stairwell must be cleaned at least once a week. In bad weather conditions (for example increased rainfall) wet cleaning should be performed more often within the deadlines set by the manager of the building.

### **Windows should be cleaned at least once a year.**

If the manager of the building finds that it is necessary to disinfect, disinsect or deratise the common areas of the building, she/he must inform the owners of the residential building and other persons in the building in writing at least five working days in advance about the relevant actions to be taken to eliminate the detected danger.

### **Sanitary maintenance of the building water supply system**

The manager of the building is obliged to constantly ensure the hot water temperature at the outlet of the heat exchanger not lower than +55 °C.

The manager of the building is obliged to distribute at least quarterly to the building owners and other persons in the building the informative material available at the website of the national authority responsible for disease prevention and control on individual preventive measures in individual properties.

### **Maintenance of buildings and structures: supply of heat energy, natural gas**

---

Heating and hot water supply in buildings and structures shall be provided and payment for these services shall be made on the basis of an agreement

entered into by the owner of the facility or a person authorised by him or her with the heat energy supplier.

Tenants of non-residential premises in residential buildings shall enter into direct contracts for heating and hot water supply by mutual agreement with the heat energy supplier, if the owner of the building does not wish to enter into such contracts. However, the legal requirements of each country must be observed.

For example, in Latvia a heat supplier who has supplied the building with heat in the previous heating season is not entitled to refuse to enter into an agreement if the building owner has paid in full for the heat received or agreed with the supplier on debt repayment terms and fulfils the agreement, as well as if the owner of the building agrees to pay the supplier for the supplied heat energy within the specified time and according to the previously determined tariff. The heat supply agreement must stipulate that the heat received in the previous month must be paid for no later than by the twentieth day of the following month. If for some reason it is not possible to pay within this term, the owner of the building must agree with the heat supplier on the settlement of debts and the further heat supply regime by the twenty-fifth day of the current month. Heat producers must buy fuel under conditions of competition – as cheaply as possible, thus ensuring the production of the cheapest possible heat.

In turn, the supply of natural gas takes place automatically, only for consumption purposes it is necessary to set the heating mode depending on the time of day, outdoor air temperature and the desired level of comfort. The natural gas heating system is compact and does not require space for fuel storage. Natural gas can also be used for water heating, cooking, fireplace heating and other purposes. By adjusting the tariffs according to the real calorific value of natural gas the customer does not remain a loser comparing, for example, with the risks of firewood quality. When paying for the used natural gas on an equalized basis, the same monthly fee is ensured throughout the year. For the convenience of consumption, it is desirable to use the possibilities of electronic services, but for security – the emergency service. Although natural gas is not a renewable energy resource, it produces the lowest emissions of CO<sub>2</sub>, ash, soot, odour sources and other elements, among fuels.

## **Maintenance of buildings and structures: provision of water supply and sewerage services**

---

The aim of providing water supply and sewerage services is to promote the availability of high-quality and environmentally sound water management services in order to provide service users with continuous and safe services, balancing environmental protection, sustainable use of natural resources and economic interests of society.

The provision of water supply and sewerage services must comply with the requirements of each country's legislation which stipulates:

- 1) the competence of public institutions in ensuring the availability of water management services;
- 2) general requirements and procedures for the provision and use of water management services;
- 3) the rights and obligations of the service provider and the service user.

## **Maintenance of buildings and structures: municipal waste removal**

---

In each country, requirements are set for the collection, transportation, transshipment and storage of municipal waste in the administrative territory of the municipality. There must be a regulated procedure for the management of sorted municipal waste, certain requirements for waste containers and waste container disposal sites as well as a certain waste generation and management control system. There must be a certain procedure prescribed for determining fees and making payments for municipal waste management as well as liability stipulated for non-compliance with waste management requirements.

## **Maintenance of buildings and structures: supply of electricity**

---

Energy is one of the most important elements in the development of society which directly contributes to economic growth. The energy sector in the region, as well as around the world, is currently undergoing changes due

to ever-evolving technologies and user requirements. As a result, energy companies are expanding and revising their frontiers, offering new approaches and services. Thus, managers of buildings and structures have a wide range of opportunities in cooperation with energy companies to ensure high-quality, safe and environmentally-friendly energy supply in maintenance of buildings and structures.

### **Maintenance of buildings and structures: inspection, maintenance and routine repair of buildings and structures, equipment and engineering facilities**

---

Inspection, maintenance and routine repairs of buildings and structures, equipment and engineering facilities therein shall be performed in order to ensure the maintenance (physical preservation) of the objects under consideration throughout their operation and to prevent the occurrence of danger.

The technical condition of buildings and structures, their construction as well as the equipment and engineering networks therein shall be determined by visual inspection. Visual inspection of building structures as well as parts of equipment and engineering networks which cannot be accessed due to the technical construction solution of the building shall not be visually inspected. The fact of the visual inspection shall be recorded in the building inspection registration log which is part of the building maintenance file (documentation).

Construction of buildings and structures, common equipment and parts of engineering networks located in groups of residential and non-residential premises shall be visually inspected once a year on a random basis, if the owner of the building has provided such an opportunity. If the owner of the building does not provide the manager with the opportunity to perform visual inspection, the said fact shall be recorded in the building inspection registration log.

Repairs are carried out to ensure the continued operation of the building, its equipment and engineering networks. Types of repairs:

- 1) extraordinary repairs – timely prevention of the above-mentioned damage;
- 2) planned repairs – prevention of damage within the term specified by the manager of the building.

The boundary of ownership of a building, its equipment and engineering networks is determined by regulatory enactments or agreements entered into by the manager of building and the respective service provider.

### **Maintenance intervals and inspections of buildings and structures, their equipment and engineering networks**

---

The manager of the building maintains the maintenance, visual inspection, technical inspection and damage prevention of the building, its equipment and engineering networks.

If the building contains equipment and engineering networks belonging to other persons, the manager of the building may not prevent the owner of the relevant engineering network from providing its maintenance, visual inspection and technical inspection.

The maintenance intervals and maintenance activities of the building, its equipment and engineering networks shall be determined by the manufacturer or regulatory enactments. If the manufacturer's instructions are not available or the said intervals and actions are not specified by regulatory enactments, they shall be determined by the manager of the building.

In order to use heat more efficiently, as well as to facilitate payments, the manager of the building must monitor and regulate the heat regime depending on the time of day and the summer or winter period.

### **Maintenance of buildings and structures: ensuring compliance with the requirements for buildings and structures as environmental objects**

---

The goal of ensuring the fulfilment of the requirements set for the building and structure as an environmental object is to ensure the preservation and restoration of the quality of the environment as well as the sustainable use of natural resources. For example, in Latvia the preservation and restoration of environmental quality is determined by the country's location on the continental shelf and the existence of exclusive economic zones.

The conditions for the preservation and restoration of the environmental quality of a building and structure as environmental objects are determined in accordance with international law applicable to the discharge of hazardous and other harmful substances:

- 1) in the internal waters of the country;
- 2) in the territorial waters of the country;
- 3) in the exclusive economic zone of the country or in an equivalent zone established in accordance with international law;
- 4) in straits used for international navigation, observing the transit regime, in accordance with Chapter 2 of Part III of the United Nations Convention on the Law of the Sea as of 10 December 1982, insofar as the relevant strait is under the jurisdiction of a Member State of the European Union;
- 5) on the high seas;
- 6) from ships flying the national flag – at any place where the ship is located.

### **Principles of environmental protection**

Environmental policy in the country is developed and decisions that may affect the environment or human health are made in compliance with the following environmental protection principles:

- 1) the ‘polluter pays’ principle – a person shall cover the expenses related to the assessment, prevention, limitation and elimination of the consequences of pollution caused by his or her activities;
- 2) the precautionary principle – it is permissible to restrict or prohibit an activity or measure which may affect the environment or human health but the effects of which have not been sufficiently assessed or scientifically proven if the prohibition is a proportionate means to protect the environment or human health. The principle does not apply to urgent measures taken to prevent the threat of injury or irreparable damage;
- 3) the principle of prevention – a person shall, as far as possible, prevent the occurrence of pollution and other effects harmful to the environment or human health, but if this is not possible, shall prevent the spread thereof and the negative consequences thereof;
- 4) the principle of evaluation – the consequences of any such activity or measure which may have a significant effect on the environment or human health must be evaluated prior to the authorisation or commencement of the relevant activity or measure. An action or measure which may adversely affect the environment or human health, even if all environmental protection requirements are complied with, shall be permissible only



if the expected positive result for society as a whole exceeds the damage caused to the environment and society by the action or measure.

The basic principles of regional development must also be observed when formulating environmental policy and taking decisions.

### **Environmental policy planning**

When developing draft policy planning documents and regulatory enactments, the developer must evaluate their impact on sustainable development and the environment in the abstract of the draft planning documents or regulatory enactments. Draft policy planning documents (including buildings and structures) must be subject to a strategic environmental assessment, if this is specified in the regulatory enactments regulating environmental impact assessment.

### **General public environmental rights**

Every individual, associations, organisations and groups of persons have the following rights:

- 1) to require that state institutions and municipalities, officials or private entities terminate such an activity or inactivity which deteriorates the quality of the environment, harms human health or endangers their life, legal interests or property;
- 2) to support environmental protection measures and cooperate with state institutions and municipalities in order to prevent the performance of such activities, including the adoption of such decisions which may worsen the quality of the environment or are in conflict with the requirements of environmental regulatory enactments;
- 3) to provide information to state institutions and municipalities regarding activities and measures that affect or may affect the quality of the environment as well as information regarding the negative changes observed in the environment that have arisen due to such activities or measures;
- 4) to submit proposals to state institutions and municipalities regarding the legal framework and the developed draft documents in the field of environment.

### **Public right to environmental information**

The society has the right to receive environmental information from state and municipal institutions in writing, audio recording, visual, electronic or other form. In addition, the public shall have the right to receive information, where available, on measurement procedures, including methods of analysis, sampling and pre-treatment methods, or on any other standardised procedure used to compile information on environmental factors.

The applicant for environmental information does not have to justify the purpose for which this information is required.

### **Public participation in environmental decision-making**

The public has the right to participate in the decision-making and drawing up the planning documents, including drawing up the amendments to those documents that may affect the environment. The public has the right to make proposals or express an opinion before taking the relevant decision or drawing up the final version of the document.

## **Maintenance of buildings and structures: ensuring compliance with the minimum requirements for the energy performance of buildings and structures**

---

### **Requirements for ensuring energy efficiency of buildings and structures**

The manager of buildings and structures shall organise the installation of a meter for the accounting of the amount of heat consumed, if such is not already installed in the facility, to which the heat is supplied by a person who is not an energy supply merchant.

The manager of buildings and structures shall plan energy efficiency improvement measures, including replacement of worn-out elements or structures, if the average heat consumption of the building where the heat is used for heating and hot water production exceeds 200 kWh/m<sup>2</sup> per year or 150 kWh/m<sup>2</sup> per year, if the heat energy is used only for heating the building. When calculating the average heat consumption over the last three calendar years, the useful floor area of the building must be taken into account.

If the building has been energy certified or inspected for a heating or air conditioning system, the manager shall take into account the recommendations of the independent expert specified in the energy certificate or inspection report for the heating or air conditioning system when planning energy efficiency improvement measures.

When planning the renovation of the building, the manager must take energy efficiency measures that:

- 1) ensure such a reduction in the heat energy consumption of the building that the heat energy consumption is less than the above-mentioned level of heat energy consumption;
- 2) ensure the highest heat energy savings in relation to the funds necessary for the implementation of the measure.

If conditions are found that contribute to the release of heat into the environment, the manager must take the following measures to increase energy efficiency:

- 1) the external door must be equipped with a closing mechanism;
- 2) heating system pipes and hot water pipes located in unheated premises shall be provided with thermal insulation;
- 3) windows and doors must be sealed or replaced.

For the planning of energy efficiency improvement measures, the manager may decide to perform energy certification of the building.

Other management activities are activities related to the management of buildings and structures and are performed in accordance with the will and solvency of the owner of the buildings and structures. These include activities related to the improvement and development of buildings and structures as well as drawing up a long-term plan of measures necessary for this purpose.

## **Maintenance file (documentation) of buildings and structures**

---

The information to be included in the maintenance file (documentation) of buildings and structures shall be summarised in the following sections:

- 1) basic documents of buildings and structures – a document certifying real estate rights, a cadastral survey file of buildings and structures, a boundary

plan of the attached land plot and an agreement regarding the use of the attached land plot;

- 2) the owner (owners) of buildings and structures, the possessor of state buildings and structures (list);
- 3) technical documentation – technical passport of buildings and structures (plans, schemes), project documentation, energy passport and energy plan, opinions of technical survey of buildings and structures, etc.;
- 4) documents related to the maintenance and management of buildings and structures – the management agreement of buildings and structures, decisions taken by the owner (owners) of buildings and structures, including decisions adopted at general meetings of owners of buildings and structures, agreements applicable to management activities, management work plans, budget reports, etc.

The maintenance file (documentation) of buildings and structures shall be kept by the owner, but if the object has several owners – by the manager, unless otherwise provided in the management agreement.

### **Liability of the owner of buildings and structures**

The owner of buildings and structures shall be liable for the management of buildings and structures, including non-performance or improper performance of mandatory management activities, in accordance with the procedures specified in the legislation of each country.

### **Responsibility of the manager of the building**

The manager is responsible to the owner of buildings and structures for the performance of the management task given to him/her in accordance with the requirements specified in the legislation of each country and in accordance with the provisions of the concluded management agreement. The manager shall be liable for non-compliance with the requirements of law when performing the management task in accordance with the procedures prescribed by the law of the respective country. The liability of the manager of buildings and structures shall take effect from the moment specified in the management agreement.

## 6.2. USE OF DIGITAL TECHNOLOGIES IN REAL ESTATE MANAGEMENT

---

***Maris Kalinka,***

Institute of the Civil Engineering and Real Estate Economics,  
Riga Technical University

***Ineta Geipele,***

Institute of the Civil Engineering and Real Estate Economics,  
Riga Technical University

***Janis Zvirgzdins,***

Institute of the Civil Engineering and Real Estate Economics,  
Riga Technical University

---

Digital technologies in Real Estate Management are one of the tools for analysing the quality of the lifecycle of buildings. With the quality we are not thinking only visual design of the view but also see full management of the property, like the climate, ergonomic, design, environmental, building construction, construction properties, analysis, etc. Digital technologies help to understand the real situation to collect regular information with several tools and put it in databases and give the results of analysis. Wooden public buildings use very specific construction elements and environmental materials for protecting the wood from climate and also are visually aesthetic. Wood in construction is a natural material requiring monitoring. The main requirements are humidity, ventilation, presence of pests, ecosystem and fire treatment. Fire safety is an important factor that makes us particularly think about maintaining a wooden building. Wooden structures can contain various pests, which is a major disadvantage of timber frame houses. The wood should be treated regularly with a special bioservice solution that will protect the wood from both pests and fire (Kolaitis et al., 2014).

Wooden buildings have a high degree of durability, but any artificially constructed building may require replacement of structural elements, interior or exterior modifications. It is necessary to understand and analyse what

constructive solutions have been or will be used. To understand the processes for repairing, reconstruction or renovation, BIM is a very good help.

In the control problematics in buildings we need to consider the four main factors that affect life quality inside of them (Novák et al., 2016):

- thermal comfort;
- indoor air quality;
- visual comfort;
- aural comfort.

The goal is to improve those factors with the least amount of building's operating costs possible, ideally, even reducing them. Therefore, in summary, the control objective is:

- to provide a good comfort level – learn the comfort zone from the user's preferences if possible; ensure satisfactory comfort level (thermal, air quality and illuminance) with good dynamic performance;
- to increase energy savings – combine the comfort conditions control with an energy saving strategy;
- to improve air quality control – provide enough ventilation to keep CO<sub>2</sub> levels low, possible use of controlled ventilation (DCV) systems.

A good control system ought to have many benefits such as minimizing the energy consumption, reducing the pollution caused by energy usage, improving the comfort, preventing out of hours operation of the equipment, reducing the maintenance cost and limiting the excessive wear and tear associated with the building systems (Perera et al.,2014):

- thermal comfort can be measured by the predictive mean vote (PMV) and predicted percentage of dissatisfied (PPD), presented in ISO 7730:2005;
- visual comfort is about having enough luminance level either by solar radiation or by lighting based on EN 12464-1 and EN 12464-2 standards;
- aural comfort is related to the acoustical environment inside a building, which means speech intelligibility and privacy;
- CO<sub>2</sub> concentration inside a building characterizes the level of indoor air quality (IAQ).

There are a many other standards (Novák et al., 2016):

- EN15251 specifies indoor environmental input parameters for design and assessment of energy performance of buildings addressing indoor air quality, thermal environment, lighting and acoustics;

- ANSI/ASHRAE Standard 55 defines the range of indoor thermal environmental conditions acceptable to a majority of occupants but accommodates an ever-increasing variety of design solutions intended both to provide comfort and to respect today's imperative for sustainable buildings;
- ISO 7730.

This chapter shows how to use digital instruments for controlling the air conditions, humidity, temperature and for inspections of the wooden building constructions. The chapter describes the principle of the building management systems, digital sensors and digital inspection.

### 6.2.1. Digital Inspection Tools

---

Visual inspection is one of the oldest and most widely used tools for inspecting and monitoring buildings. Visual inspection provides only part of the information that the human eye can see. Thus, we obtain only information that can be interpreted in RGB colours or visually understand whether the wood material is intact or damaged. Visual inspection also allows to touch the material and understand its internal structure from the touch. Digital tools allow to look deeper into the building elements by identifying the key parameters needed for a wooden building to last for a long time. The parameters to be determined are the internal climate data of the environment and the building element, geometric information, optical-visual information, and the resistance of the protective layers to the effects of the environment. This sub-chapter provides an in-depth look at tools that help inspect wooden buildings using digital visual inspection and climate control tools to obtain geometric information.

#### Visual and geometrical digital inspection tools

---

The use of digital tools to collect visual and geometric information from buildings is one way to gather information that is available long after the fieldwork has been completed.

There are many ways to get and save data. Photogrammetry and laser scanning tools are widely used to obtain data. These tools complement each other to

produce both high-precision geometric information and high-resolution visual information. Digital tools that can be used are both simple for everyday use: a camera, a laser rangefinder, as well as high-end - laser scanners and unmanned aerial vehicles. This section discusses the use of laser scanners, drones, and simple rangefinders or cameras for digital survey of buildings.

### 3D Laser scanning

---

Laser scanning is the measurement of the distance to the surface and back using a visible or invisible laser. This method for surveying buildings has been widely used since the 21st century. With the development of technology and data processing software, laser scanning is becoming one of the leading methods for collecting geometric information data about terrain – buildings, structures, vegetation, surfaces, soil, etc., combining laser scanning data with photogrammetry data results in a high photorealistic set of 3D points. By supplementing the data with photogrammetric data, it is possible to obtain information in places where secure access is not possible. Laser scanning is a surveying technology that allows to obtain high-precision 3D data about the geometry of the object and the environment in a short time. The survey results in a 3D point cloud consisting of several million points, where each point has its own XYZ coordinate. Figure 6.1 shows a point cloud of the wooden



**Fig. 6.1.** Wood building in 3D point cloud after renovation (developed by authors).



building. At the same time, depending on the scanner parameters, it is also possible to obtain RGB colour and intensity with 3D laser scanning. Laser scanning became more widely used in construction in the late 1990s, when one of the first laser scanning systems was developed. When performing a survey with a laser scanner, high-precision and high-resolution 3D data about the surveyed object are obtained in a short time. Laser scanning data consists not only of XYZ coordinates, but also of high-resolution photographs, which give each measured point its own RGB colour, and the point cloud resulting from the scan can be linked to a construction site or national coordinate system. The data and products obtained as a result of laser scanning are used both in the supervision of buildings and in the renovation and reconstruction of buildings.

A laser scanner is a device that analyses real-world objects and the environment by obtaining data about their geometric shapes, textures, and colours.

The beginning of laser scanning can be tracked back to the 1960s. The first scanners used a combination of light, camera, and projector to accomplish the intended tasks, but due to limited equipment and the complexity of scanning, it often took a long time to accurately measure objects. After 1985, the first scanners were replaced with scanners that used white light, lasers, and shading to obtain the desired surface image. It was also the beginning of 3D laser scanning technology as it is today (Abdel, 2011). However, it was not until the late 1990s that laser scanning entered also the engineering industry.

One of the first 3D laser scanning systems, the Cyrax prototype, was developed in 1997 by Cyra Technologies. The prototype was huge. It was built into an old Volkswagen car and had a measuring speed of 30 dots per second (see Fig. 6.2).



**Fig. 6.2.** Cyrax laser scanning system: a) prototype, b) model *Alpha* (Cheves, 2014).

The most important software for laser scanning data is the one that is designed to process laser scanning data and create a point cloud. Most laser scanner manufacturers have developed their own data processing software because each manufacturer has its own file format in which it stores information. However, some manufacturer's software is also designed to process laser scanner data from other manufacturers.

The laser scanner emits a laser beam at the object and measures the distance from the laser scanner to the object by measuring the return time from the emitted to the reflected beam. The data acquisition speed is currently more than 2,000,000 measurements per second.

Laser scanners are also divided by wavelength (see Fig. 6.3):

- visible laser scanner (laser beam is usually green): 532 nm;
- near-infrared scanner: 700–1300 nm;
- infrared scanner: 1330–1550 nm.

Table 6.1 shows the main using field and types of the laser scanner. Airborne laser scanning is used for collecting information of the surface from airplanes or unmanned aerial vehicle. The main aim of using this system is to collect information for large area in short time. The main results are a surface model of the area and an orthogonal area image. *Airborne laser scanning* – widely used laser scanners for surveying the geometry of the buildings or infrastructure in short distances – 100 m. The main results are point clouds. Micro Ls are used

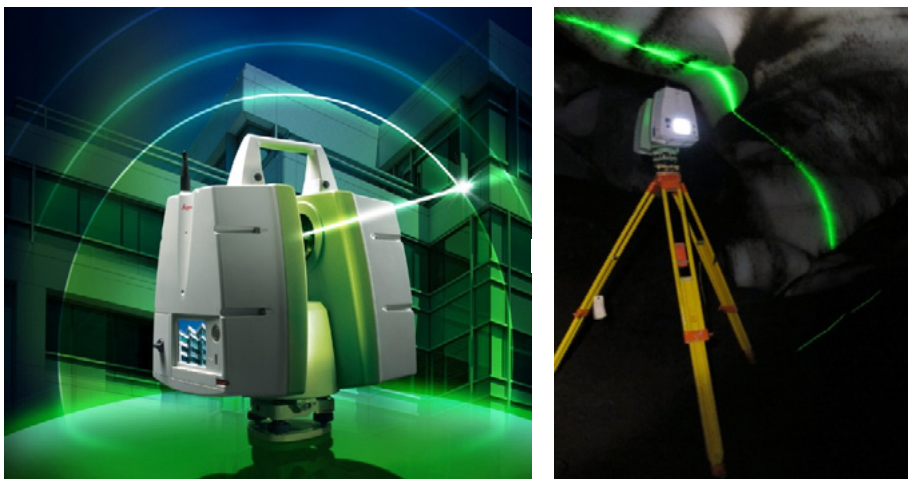

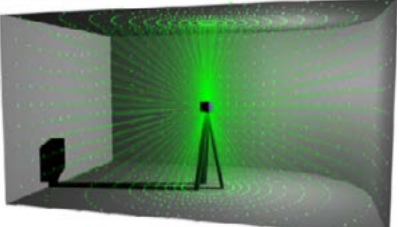




Fig. 6.3. Laser scanner with visible laser (LEICA Geosystems, 2020).

for very short distances with high precision. The main field is interior objects. Dynamical-moving scanners are used for very fast data collection to do work in mowing process.

Table 6.1

Laser Scanner Types and Usage (Developed by Authors)

Laser scanner	Usage	Image
ALS – <i>airborne laser scanning</i>	Scanners used from aircraft to obtain large areas of 3D data, e.g. in agriculture, forestry, urban areas, etc.	
TLS – <i>terrestrial laser scanning</i>	Scanners used for static ground surveying. The scanning distance can range from a few metres to several kilometres.	
<i>Micro LS</i>	Scanners used to scan objects at close range, e.g. in reverse engineering, prototyping, documentation of cultural monuments, etc. The scanning distance is from a few millimetres to a few metres.	
Dynamical-moving scanners	Allow to scan the surroundings while moving. The data is provided with an accuracy of a few centimetres.	

### **Factors influencing the laser scanning**

Laser scanning is a very physical process that is affected by such external conditions as the environment, vibrations, object material, etc. The abovementioned factors determine the quality of the measurement and the result.

Laser scanner measurements are related to the following errors: angular accuracy, distance accuracy, resolution, boundary effects and effect of surface reflectivity.

**Angular accuracy:** The laser beam in the scanner is curved (refracted) by a mirror or prism and directed at the object. To bend the beam on another surface or perpendicular to the first, the axis of rotation of the instrument or additional optical devices are usually used. Angle reports on a specific surface are used to calculate spatial coordinate points. Any measurement errors of these angles will lead to errors in the direction measurements perpendicular to the propagation of the laser beam line. It is for this reason that errors can occur, which can only be minimized by calibrating the instrument.

**Distance accuracy:** Laser scanning systems, which are based on distance measurement, measure the distance with time after the output signal or by comparing the phases between the output and incoming beams. Such scanners are designed to work when the object is up to 100 m away, but even over longer distances they are accurate.

**Resolution:** From the user's point of view, this explanation refers to the ability to find small objects or their components in a set of points. But from a technical point of view, two different technical parameters for laser scanning systems correspond to this explanation. And they are the minimum angle between two adjacent points and the size of the laser print on the object itself.

**Boundary effects:** When the laser beam falls on the edges or edges of an object, only a portion of the reflected signal will return to the system. The remaining part of the received signal is the reflection from the mixed surface behind the edge or behind a surface that has nothing to do with the object to be scanned. Systematic effects can be observed when cylindrical and spherical objects are scanned from a close distance. In such cases, in the peripheral areas of the objects, their geometric centre may not coincide with the centre of the reflected beam.

**Effect of surface reflectivity:** White surfaces are able to reflect the signal much more strongly than darker surfaces. When reflected from coloured surfaces,

the signal intensity depends on the spectral characteristics of the laser in the green, red and near infrared range. Glossy surfaces make it difficult to register signals. Surfaces with uneven reflectivity have been found to form systematic errors at distances. For some types of materials, these errors can reach a few times the VKK for single-distance measurements. To study the accuracy of measurements, flat objects in white can be used by placing the material to be analysed between them. After determining the approximate surface for this middle part and performing the same operation for the remaining white part of the object, regardless of the average object, a difference can be determined between these two surface types, which will allow to evaluate the effect of the given factor.

### **Environmental impact**

Laser scanning is related to the following environmental impacts: effect of temperature, atmospheric effects, influence of internal radiation sources.

Effect of temperature: Temperature has little effect on the operation of laser scanners because the distances are relatively short. Rather, it is possible to overheat the equipment where the internal temperature differs from the outside temperature.

Atmospheric effects: When measuring short distances, the speed of light propagation due to temperature fluctuations and / or atmospheric pressure will not have a significant effect on the measurement results. When measured in conditions with high concentration of vapor or dust in the air, results equivalent to the same effects as for edge and edge measurements are possible.

Influence of internal radiation sources: Lasers operate in a rather narrow frequency band, so filters should be used at a certain frequency in the signal acquisition module. If the radiation comes from another object (sunlight or artificial lighting) and is quite strong compared to the work signal, then a significant part of this radiation can pass through the filter and affect the accuracy or even the overall result of the work.

### **Laser scanning workflow**

Laser scanning involves a series of steps (Fig. 6.4):

- laser scanning process on field;
- data processing;
- visualization of results.



**Fig. 6.4.** Laser scanning workflow process (developed by authors).

The laser scanning process begins with a preparatory phase which includes identifying the customer's goals and objectives and desired results, examining existing data, on-site inspection to assess scanning conditions and access to all required locations (roofs, rooms, basements, attics, etc.), work planning so that everything you need can be scanned in the shortest possible time.

The task of data processing is to get a point cloud. In order to create a point cloud from the data obtained during the laser scanning process, which can be fully used for further work such as 3D modelling and BIM modelling, various types of calculations, monitoring or object analysis, the scanned data must first be post-processed, including matching and cleaning. This process can be performed in one of the laser scanning data processing programs, which in most cases is a data processing program developed by each laser scanner manufacturer.

Stages of data processing process are as follows:

- matching scans (automatic and manual);
- attachment to the coordinate system;

```

|103410724
18.12036 0.98179 24.56456 171 61 37 73
18.1667 1.06529 24.55429 168 63 43 80
18.09796 0.9647 24.58594 166 54 34 71
18.12745 0.98659 24.56544 172 62 38 72
18.23223 1.14699 24.64957 172 9 13 104
18.21556 0.94589 24.65992 159 1 11 70
18.17538 0.96645 24.59508 176 53 39 75
18.18456 1.04066 24.58462 170 60 43 85
18.18249 1.0862 24.58713 168 59 41 81
18.07549 0.95044 24.65836 165 29 22 66
18.16118 1.0643 24.55642 168 63 43 80
18.15135 0.95073 24.65052 162 12 7 74
18.18798 1.11787 24.59633 168 59 41 81
18.18266 0.96987 24.59394 166 55 39 78
18.17528 1.05935 24.57103 161 60 42 80
18.22757 1.15763 24.6518 173 0 2 71
18.20385 0.98217 24.64157 133 47 40 74
18.14335 0.98641 24.56905 168 63 37 72
18.11504 0.96121 24.58449 169 54 33 72
18.07836 0.95301 24.6143 164 48 36 76
18.10363 0.96197 24.59377 166 51 34 68
  
```

**Fig. 6.5.** Point cloud file format (developed by authors).





**Fig. 6.6.** Point cloud and 360-degree images (developed by authors).

- quality control;
- scan cleaning;
- creating a point cloud.

Once all the scans have been merged and cleared, a cloud of project points can be created and visualized by CAD or modelling software. The processing of laser scanning data results in a point cloud consisting of several million points, in which each point has its own X, Y, Z coordinates and colour. But in order for the point cloud to continue to be used in any CAD or BIM software, it must be exported to the required file format which is supported by the program in use. The most popular point cloud file formats are E57, DXF, XYZ, IGES, PTS and POD. Figure 6.5 shows the point cloud file format in PTS file format containing the point number, x, y, z coordinates, laser beam intensity and RGB colour point.

Laser scanning also produces 360-degree images as a product which can be visualized in combination with a 3D point cloud (Fig. 6.6).

Using these data products, it is possible for the building to perform both a visual virtual survey on a computer as well as to perform geometric measurements in a point cloud to use CAD software or directly in a 360-degree image.

## Digital close-range photogrammetry

---

Photogrammetry is the science of taking measurements from photographs. This method has been used for more than 100 years, but mainly to meet the needs of cartography and architecture. In the last decade, with the

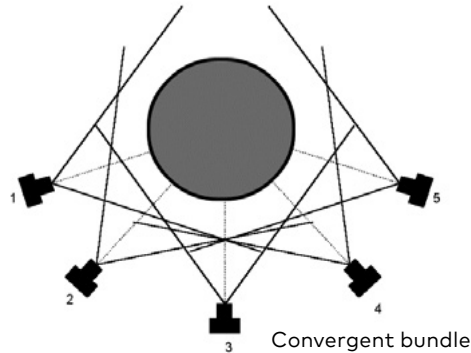
development of digital photographic and imaging technologies as well as unmanned aerial vehicles (UAV, drones), the scope of photogrammetry is expanding and becoming one of the leading methods for mass data collection on terrain – buildings, structures, vegetation, surfaces, soil, etc. There is no limit to the distance to an object in photogrammetry – it can be from centimetres to hundreds of kilometres. Unlike laser scanning, this method is more widely available because the shooting does not require expensive equipment and highly professional knowledge, the visual appearance of the result with photorealistic accuracy reflects the measured object or area, but it does not provide such high geometric accuracy. The best results are obtained by combining the laser scanning data with photogrammetry. Figure 6.7 reflects one of the results from photogrammetry – 3D reality model (Borodinecs et al., 2018).

Close-range photogrammetry (CRP) relies on the reconstruction of object simultaneously from several images from different and best possible perspective, to ensure a suitable geometry of intersecting rays. So that, close-



**Fig. 6.7.** 3D reality model of wooden building complex (developed by authors).





**Fig. 6.8.** Basic principle for taking the photography (Hanke, 2002).

range photogrammetry is meant to be in that situation when the distance (range) from the camera to the object of interest is somewhere from 1 metre to approximately 100 metres.

Photogrammetric surveying is based on comparing photos that show the same location removed from multiple viewpoints. Therefore, the main requirement is the overlap of areas covered by these images in a sufficient area, usually expressed as a percentage. Since the entire area or object to be surveyed must be covered, the photo must be taken in the same way as a tiled roof – with a partial overlap. Figure 6.8 shows the basic principles for taking the photography from drones or hand cameras.

Photo-take planning is a very important stage to ensure sufficient coverage and informative content of the acquired images in relation to the terrain objects, separate structures, linear corridor objects (roads, railways), high vertical objects (towers, chimneys, masts), interiors. For each type of object the most suitable plan and its parameters must be chosen, the most important of which are:

- distance to the object or flight altitude;
- the size of overlay between adjacent images;
- camera orientation.

The choice of the distance to the subject is determined by the accuracy and / or resolution requirements of the result and depends on the parameters of the camera: the size and resolution of the sensor and the focal length of the lens according to the above relationships. In turn, the choice may be limited by the peculiarities of the area to be measured – narrow approaches, obstacles such as trees, tall structures, air ducts, etc.

The required coverage between adjacent images depends on the type of object, the required product and the characteristics of the area. Coverage must be provided both in the direction of movement of the camera (frontal coating) and between images on the side in that direction (lateral coating).

### Survey of a separate building or group of buildings

Pictures are taken by bypassing the building. Admission must be planned in such a way that no parts of the facade are left out and obscuration is controlled. At least 60 % coverage between images must be provided. When bypassing corners of the building or changing the direction of view of the camera, it must be ensured that the viewing angle between adjacent companies does not exceed 15°. When shooting with a drone, the building is flown on several levels vertically, ensuring 60 % coverage between images of adjacent levels. It is also recommended to add ground intake. Such a plan for the reception of a structure ensures the collection of the most detailed information about what allows to reconstruct the geometry of the structure. The obtained data products are further used to determine and document the technical condition of the building and as input data for the development of renovation and reconstruction projects. Figure 6.9 shows the main principle of trajectories using UAV technologies.

Photogrammetric data processing results in the 3D data products are a dense cloud of 3D points, where each point is represented by its X, Y, Z coordinates

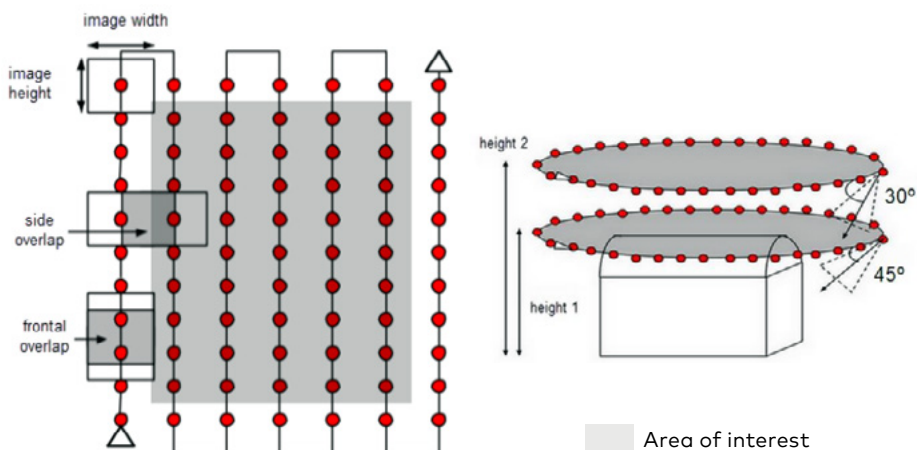


Fig. 6.9. UAV trajectories (Pix4D manuals, 2020).

and its colour in RGB encoding. This type of representation can take up a very large amount of computer memory (several gigabytes and more), as tens to hundreds of millions of points are stored. A 3D grid model is a collection of vertices, edges, and faces that represent the shape of polyhedral objects. Triangular faces are usually used. Faces can be represented with textures to create a photorealistic object model. Such a model significantly saves computer memory compared to the point cloud (by several layers).

The quality and applicability of these data products are characterized by two indicators:

- Geometric accuracy – the correspondence of the spatial position of points (points to the cloud) and vertices (grid model) to the position of the corresponding point in the object to be measured. In the case of photogrammetric surveying, the accuracy is determined by the camera parameters (sensor size, sensor resolution, focal length), shooting distance (height) and image capture according to the photogrammetric requirements as well as the optical properties of the subject.
- Level of detail – point density (point cloud) and number of faces per unit surface area (grid model). The higher the level of detail, the more detailed the details of the object in the point cloud or grid model. The required level of detail is given as an input parameter in the data processing.

Figures 6.10, 6.11 and 6.12 show 3D reality models in different periods: before renovation process, during renovation process and after renovation process.



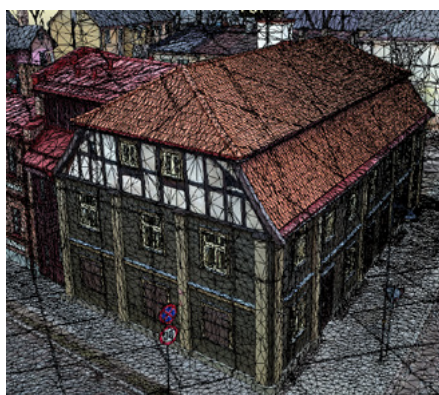
**Fig. 6.10.** 3D reality model before renovation process (Jelgavas Vecpilsētas ēku pārbūve, restaurācija, 2020; Tehnoloģiju pieskāriens vēsturei, 2020; Jelgava old city, 2020).



**Fig. 6.11.** 3D reality model during renovation process (Jelgavas Vecpilsētas ēku pārbūve, restaurācija, 2020; Tehnoloģiju pieskāriens vēsturei, 2020; Jelgava old city, 2020).



**Fig. 6.12.** 3D reality model after renovation process (Jelgavas Vecpilsētas ēku pārbūve, restaurācija, 2020; Tehnoloģiju pieskāriens vēsturei, 2020; Jelgava old city, 2020).



**Fig. 6.13.** 3D reality model in mesh format (developed by authors).

The reality models and mesh models (Fig. 6.13) give possibilities to understand the building geometry, to measure dimensions or cross sections directly in software.

Visual material gives distance researching from computers. Maintenance process with reality models gives possibility to understand periodical changes.

## Laser distance meters

---

Laser distance meter is a device that measures distance using a laser beam. Such devices are widely supplied in engineering surveying, topographic surveying, navigation, architecture and construction. Laser distance meter is very compact with many features as well as operating in a short time. Figure 6.14 shows a simple laser distance meter to measure the distance angles for calculating the plane and height values between elements.

The 3D laser distance meter is a laser scanner designed for measuring complex architectural structures, rooms with non-standard walls with different angles, as well as rooms with many small details (Fig. 6.15). Laser distance meter with a built-in electronic angle reader can read the distance to the object, horizontal and vertical angles and assign coordinates to a point in the local coordinate system. Using its own software, the tool can instantly create a spatial project by drawing lines, circle and other geometric shapes between points. Using automatic motors, the tool, like the scanner, can scan surfaces and lines. As well as by operating the instrument manually, it is possible to measure only those points that are necessary. They facilitate the post-processing process. When controlling the instrument using the control board, it is possible to



**Fig. 6.14.** Simple laser distance meter (GPS Partners, 2020).



**Fig. 6.15.** 3D laser distance meter (GPS Partners, 2020).

take measurements remotely from the instrument because the connection is established with a WiFi signal emitted by the instrument. The whole project remains on the tablet, as well as using the instrument's built-in camera, it is possible to see what the instrument sees, which facilitates measurement and endorsement. The project can be exported in DXF format.

## Simple photo measure tools

---

Measuring images is one of the fastest tools for getting both image and geometry information at the same time. Such tools can be combined with both a photo taking function and a distance detection function between the objects shown in the images. Another tool is 360-degree images providing full around image. Figure 6.16 demonstrates the results from image measurement tools. Use of the tool with functions directly taking image measurements gives possibilities determining the extent of damage immediately at the site.



Fig. 6.16. Photo 3D measurement tool (GPS Partners, 2020).

## Conclusion

---

Digital tools help to understand the building during its maintenance period and make it possible to understand the behaviour of structures, including the most important components such as foundations and the roof. Wooden structures are affected by practically any geometric change that exceeds the limit value and the wood breaks. Ground stability or the movement of structures is mainly influenced by meteorological parameters such as wind, snow, rain and temperature.



## 6.2.2. Digital Sensors for Climate and Energy Analysis in Buildings

---

This chapter shows how to use digital sensors for controlling the air conditions, humidity, and temperature. There are various digital sensors in the world for smart building and you can find a lot of possibilities how to control the climate inside for living and for building construction. This section shows only a few types of sensors without mentioning a specific manufacturer or developer. The main task of sensors is to collect and record data and display the real situation in real time or from the database on the situation in advance through applications. Digital climate sensors can be connected to building management systems (BMS) and act as a single element in climate monitoring. The second type of sensors signed in this section are stability sensors for building structures, such as the movement of a building under the influence of wind or ground stability. Deformation limits control for rafters, curved busbars and beams.

Climate control sensors are usually used in conjunction with energy saving resources. This chapter contains parts from *The Advanced Controls / Performance Monitoring and Control of Integrated Systems* from H2020 project *Development and advanced prefabrication of innovative, multifunctional building envelope elements for MODular RETrofitting and CONNECTIONs* (Novák et al., 2016).

The main factors influencing the longevity of wood are loads, moisture and cracking of wood. All these factors are interdependent. In turn, the mechanisms for controlling the strength limits of wood are selected according to the type of wood construction, which may be different for round wood, glued wood or wood of lumber type. Maintenance and monitoring tools are usually determined at the design stage. They are different for beams, poles, trusses, pavements, etc.

### Digital climate control tools

---

Dry air can cause problems with wooden furniture, stairs, floors, and doors. This is especially true during the heating season when the indoor humidity often drops below 25 %. When it dries strongly, the wood starts to crack. Cracking occurs during the use phase. Cracks appear in the parquet, etc.

Most used control strategies for climate and energy systems are reflected in Table 6.2.

Table 6.2  
Control Strategies (Novák et al., 2016)

On/Off control (Thermostat)	<ul style="list-style-type: none"> <li>Feedback type</li> <li>Availability</li> <li>Generic</li> <li>Well understood</li> <li>Low initial cost</li> <li>Simple structure</li> <li>Fast response</li> </ul>	<ul style="list-style-type: none"> <li>Accepts only binary inputs</li> <li>Often incapable of tracking the setpoint accurately and hence could be inefficient</li> <li>Not versatile and effective in the long run</li> </ul>
Feed forward control (Weather compensator)	<ul style="list-style-type: none"> <li>Availability</li> <li>Increased energy savings</li> <li>Very fast reaction to changes</li> </ul>	<ul style="list-style-type: none"> <li>Open-loop type</li> <li>Negligence of all effects related to unmeasured signals / disturbances</li> <li>Unpredictable changes of the system behaviour</li> <li>Parameter storage requirements to accommodate many operating conditions</li> <li>System performance not measured</li> <li>Possibility of system failure if the relationship between the environmental measurements and system model parameters change</li> </ul>
PID control (Feedback)	<ul style="list-style-type: none"> <li>Feedback type</li> <li>Robustness to disturbances</li> <li>Derivative term combat with sudden load changes in the system</li> </ul>	<ul style="list-style-type: none"> <li>Little measurement and process noise can cause large variations in the output due to derivative term</li> <li>Energy inefficient</li> <li>Tuning is time consuming</li> </ul>
MPC	<ul style="list-style-type: none"> <li>Increased energy savings</li> <li>Cost effective</li> <li>Robustness to disturbances</li> <li>Can involve bounds</li> <li>Control of multiple variables</li> <li>Steady state response improvement</li> <li>Future disturbance prediction</li> <li>Prediction of future control actions</li> <li>Better transient response</li> <li>Handles slow moving processes with time delays</li> </ul>	<ul style="list-style-type: none"> <li>Need to identify a suitable model of the system</li> <li>Installation could be expensive</li> <li>Set-up can be time consuming</li> </ul>



**ON/OFF** technique examples: thermostat, humidistat, and pressure switch. Commonly found in home heating systems and domestic refrigerators. Most used in HVAC systems due to the advantages it offers. However, intensive oscillations during operation and low energy efficiency reflect high cost of both maintenance on actuators and energy.

Advantages:

- simplicity;
- low initial cost.

Disadvantages:

- high maintenance cost;
- low energy efficiency.

**Weather-compensated (equithermal) control.** A feed-forward type of control, known in the market as equithermal controller for HVAC systems. The disturbances are measured and accounted for before they have time to affect the system. This strategy responds to its control signal in a pre-defined way without a feedback technique (not-error based), which means it is based on the knowledge of the process or measurements of its disturbances.

In heating systems, weather compensation is a communication between the source of hot water (boiler, for example) and an outside temperature sensor. Since the weather has the main influence on the heat demand of a building, the controller adjusts the heat supplied according to the weather conditions and inside temperature setpoint, via pre-defined heating curves, ensuring a more constant temperature in the rooms and better energy savings (15 % according to some system manufacturers).

**PID controller** continuously calculates the error between the desired setpoint and a measured process variable and adjusts the control signal accordingly. It is also known as feedback control for HVAC systems (Balas et al., 2013).

‘Proportional’ accounts for present values of the error. For a large and positive error, for example, the control signal will be proportionally large and positive.

‘Integral’ accounts for past values of the error. For example, if the current control signal is not strong enough, the error will accumulate over time and the controller will respond by applying a stronger action.

‘Derivative’ predicts the future offsets based on the actual rate of change of the process and suppresses oscillations.

A PID controller is very versatile and can be widely applied because it does not use knowledge / model of the interested system. When correctly tuned, the controller can adjust its output to match the power that is required to keep the process stable at the setpoint. However, it requires the tuning for this purpose, creating some limitations and inconveniences (Ashida et al., 2017).

**Model predictive control (MPC).** Predictive control applied to building automation systems provides increased energy savings, being often more cost-effective than non-predictive control applications and providing some other benefits too. They can be applied to both single-zone and multi-zone buildings, whether residential, commercial or public buildings. However, the decision of implementing the predictive control for a particular building depends on the payback period. This multivariable control technique is based on a prediction model using past information and future inputs to predict what the future output should be. While controlling the process according to the model, MPC generates a cost function control vector to minimize it over the prediction horizon, disturbances and constraints that might be present. Model identification is the bottleneck of the whole MPC application procedure, and there are no strict requirements on the model structure. It is possible to use any black box, grey box, or white box model.

Main advantages (Novák et al., 2016):

- energy and maintenance cost savings;
- multivariable;
- peak load shifting capability;
- transient response improvement (decrease in rise time, settling time, and peak time);
- steady-state response improvement (decrease in offset error);
- predictions of future disturbances  $f$  – future control actions prediction;
- control of variables within bounds  $f$  – reduction in fluctuations from a setpoint (better regulation);
- efficiency and coefficient of performance (COP) improvements;
- robustness to disturbances and changes in operating conditions;
- indoor air quality and thermal comfort improvement.

Main disadvantages:

- relies on model accuracy;
- strong dependence on the model;
- need to identify a suitable model of the system;
- installation could be expensive (e.g. use of remote server for calculation);

- a direct implementation to PLC is not possible;
- needs computational time;
- does not account for user controllability, and subjective level of comfort is not adaptive.

## Digital sensors for building construction stability control

---

The main task for the stability of digital sensor structures is to follow the behaviour-deformation of structures under the influence of external processes. Possible external processes can be weather conditions: wind, temperature and precipitation, as well as soil stability. The most popular are tilt meter and joint & crack meter.

### Tilt sensor

The main task of the tilt sensor is to follow the vertical or horizontal-spatial deviation of the structure from the design position. Tilt meters are designed to measure tilt on submerged structures either on a vertical, inclined or horizontal surface.

They consist of highly accurate MEMS sensors mounted in robust watertight stainless-steel housing which can be attached to the structure by bolting, bonding or welding.

Each unit is individually calibrated to provide the ultimate in system accuracy and repeatability and can be used in conjunction with a hand-held readout, automatic data acquisition system and Wi-SOS to provide a wireless monitoring solution. Figure 6.17 shows that the MEMS tilt beams are designed for attachment to structures, on either a vertical or horizontal surface, for the measurement of tilt or differential settlement.



Fig. 6.17. Geosense MEMS tilt beam (Geosense, 2020).

### Joint & crack meters

Crack meters are designed to measure displacements across cracks and joints typically in buildings, bridges, dams, pipelines and rock formations. They are used for measuring movement in one (1D) or three axes (3D).

Joint meters are ideal for monitoring movement of joints between two structures. Typical applications include abutments, slabs, foundations and retaining walls, tunnels or shaft linings, arch, gravity, and buttress dams. Also, it is possible to use them for wooden construction joints.

Data can be obtained using a portable readout or connected into a data logger for automatic monitoring. Figure 6.18 shows an example of crack meter for controlling distance movements between two constructions.

Building monitoring process is one of the parts in maintenance plan. Combining sensors with geometrical information and bringing raw data to



**Fig. 6.18.** Geosense joint & crack meter between two constructions (Geosense, 2020).



**Fig. 6.19.** Public wooden building with wood construction elements (Koka ēku renovācijas centrs "Koka Rīga", 2017).

Management database systems, it will be possible to analyse the building with BIM or GIS systems. Regular analysis of the data forms a monitoring process. Analysis of monitoring results provides an opportunity to regularly improve maintenance tasks for buildings. Figure 6.19 shows a public building with massive wooden structures that perform both the aesthetic function and the structural durability function. This building needs regular visual and geometrical control with sensors.

### Digital tilt logger

The digital tilt logger (Fig. 6.20) is a simple, battery-powered data logger and tilt meter in a single compact unit. It measures tilt in either one or two perpendicular axes in the plane of the base. The unit is intended to be permanently installed to provide long-term observation with maximum resolution and sensitivity and is conveniently designed for manual monitoring or remote data acquisition.

The sensor is usually used for observations of vertical structures – for observation of vertical tower supports.



Fig. 6.20. Digital tilt logger (Geosense, 2020).

## Conclusion

---

Digital building surveillance tools help manage a building as a safe place for people to stay and as protection of structures against damage. Using digital sensors, we obtain data in real time or very close to real time by pre-processing it. Sensor indicators and processing results should be published on web services. Digital technical tools help to quickly determine the safety performance of buildings and at the same time monitor the climatic parameters in the building.

## 6.3. DATA BASE FOR MANAGEMENT PURPOSES

---

***Maris Kalinka,***

Institute of the Civil Engineering and Real Estate Economics,  
Riga Technical University

***Ineta Geipele,***

Institute of the Civil Engineering and Real Estate Economics,  
Riga Technical University

***Janis Zvirgzdins,***

Institute of the Civil Engineering and Real Estate Economics,  
Riga Technical University

---

The main task of the building management database is to ensure the management of the processes related to building management and timely execution of building maintenance tasks. Various database management systems can be used for building management: building information modelling systems, building management systems, facilities management systems, geographical information systems. Guided by the type of database structure, we can divide building management into the following groups: textual or analytical databases, graphical databases, and combined systems of both databases.

Building information modeling (BIM) is a process that begins with the creation of an intelligent 3D model and enables document management, coordination, and simulation during the entire lifecycle of a project (plan, design, build, operation and maintenance) (Autodesk, 2020).

The building management system must provide three main functions: event logging, data storage and process traceability. BMS systems are 'intelligent' microprocessor-based controller networks installed to monitor and control a buildings technical systems and services such as air conditioning, ventilation, lighting and hydraulics.

The term ‘facilities management’ (FM) has been the subject of much debate since its conceptualization. “Facilities management brings together knowledge from design and knowledge from management in the context of buildings in everyday use” (Finch & Zhang, 2013).

GIS is one of the tools that helps to manage a building through both visualizing and analysing building information. It is a system that helps to identify the scene and display it in space. The key functions of GIS use in facilities management are spatial visualization and geodatabase management functions. It has been used extensively for facilities management in the public sector and has great potential for use in the private sector as well. GIS has been used to assist in the management of building spaces and facilities in recent years (Mwaniki & Odera, 2014). GIS as a building maintenance tool allows to view a building as a spatial object in a real environment by integrating the results of data analysis of building in 3D GIS.

The building database management system must be based on a maintenance plan. All procedures of the maintenance plan must be registered and traced.

### 6.3.1. Building Information Modeling System

---

BIM (building information modeling) is the process of creating and managing data over the life cycle of an object. The obtained information model is used as a basis for decision-making, as it includes objective information, from the idea to the conclusion of the operation phase of the building.

Building information modeling process supports the creation of intelligent data that can be gathered throughout the lifecycle of an infrastructure or building project.

BIM life cycle includes the following processes (Autodesk, 2020):

- Planning – reality capture and real-world data are used for project planning to generate context models of the existing built and natural environment.
- Designing – conceptual designing, analysis, detailing, and documentation are carried out. The preconstruction process begins using BIM data to inform scheduling and logistics.
- Building – fabrication begins using BIM specifications. Project construction logistics are shared with trades and contractors to ensure optimal timing and efficiency.

- Operating – BIM data carries over to operations and maintenance of finished assets. BIM data can be used down the road for cost-effective renovation or for efficient deconstruction.

Life cycle of an enterprise in BIM can be seen in Fig. 6.21.

Building information modeling (BIM) has the potential to advance and transform facilities operation and maintenance (O&M) by providing a platform for facility managers to retrieve, analyse, and process building information in a digitalized 3D environment (Gao & Pishdad-Bozorgi, 2019).

In the operation and maintenance (O&M) phase of an existing building frequently different systems are available to manage data about building maintenance. All building structures, material, finishes, and services deteriorate over time through an inevitable process of the effects of climate and usage. This process of decay can be controlled, and the physical life of the buildings can be extended if they are properly maintained (Chew et al., 2004).

BIM can be classified in three types: corrective, preventive, and predictive. The corrective maintenance concerns about a reactive maintenance in response to a cause of failure or breakdown (Motawa & Almarshad, 2013). Preventive maintenance is carried out by periodically undertaking routine tasks necessary to maintain a component or system in a safe and efficient

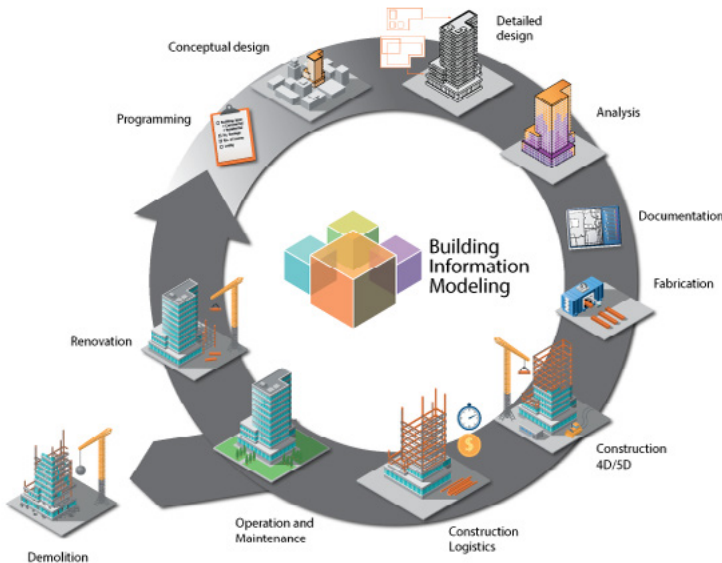


Fig. 6.21. Life cycle of an enterprise in BIM (BIMMDA, 2020).



operating condition on a regularly schedule. More recently, the advance in technology made the development of another maintenance category called predictive maintenance (Yam et al., 2001). This approach detects the system degradation and conduce maintenance on the actual condition of the facility (Bortolini et al., 2016). The BIM model (Fig. 6.22) used in the construction of a building must be refined after the construction of the building, so that the BIM can be fully integrated into the building management systems.

### 6.3.2. Building Management System (BMS)

Building management system has been introduced to this world in 1970, initially it was started with very limited features but within time a lot of changes and modifications had been made, starting with the controlling of power and lightening to heating and cooling of a building together with the alarm system as a further modification in order to provide maximum security. The main purpose of a BMS is to increase people’s comfort by maintaining the building in the desired state every time and reduce energy consumption by avoiding situations in which elements are being overused. For instance, by predicting the time of entrance of a person in a room, it is possible to adjust the temperature in advance, or by detecting that a room is empty, lights can be turned off if they have been left on by mistake. The building management system (BMS) is an overarching control system that

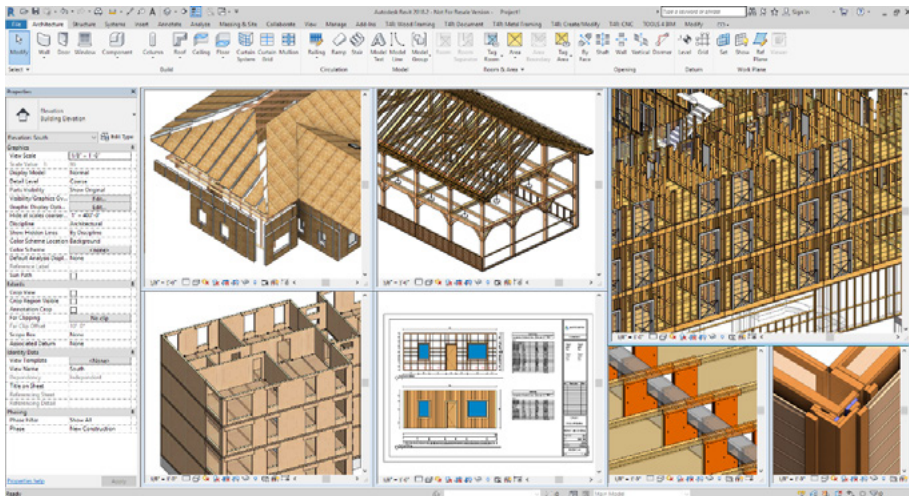


Fig. 6.22. Wood constructions in BIM (Agacad, 2020).

is responsible for the automatic regulation and control of non-GMP facility subsystems maintaining predefined parameters (or set points) and the control of their functionality. The major aim of the BMS is to guarantee the safety of facility operation, while also monitoring and optimizing the use and efficiency of its supervised subsystems to allow more efficient operation.

Examples of the major subsystems controlled by the BMS are (Joseph, 2018):

- HVAC System. The duct temperature, pressure, and humidity, as well as exhaust temperature are connected to the BMS, and if their value exceeds defined limits, an alarm is generated.
- Central fume collection, laminar flow units, dust collection system, central vacuum system, heat blowers. The BMS monitors the performance of these systems allowing for early identification of units requiring maintenance.
- Technical steam system. Should, for instance, the pressure or temperature in the piping system fall below the defined regulatory values for clean steam, the BMS shall trigger an alarm, indicating a threat to product quality.
- Hot water system and central heating. Temperature and pump control monitoring via the BMS allows for a proper functioning of hot water distribution through the facility.
- Chilled water system. Control of the facility chillers could be supervised by BMS to monitor proper behaviour of the system in terms of water / coolant temperature control or pump control to assure proper distribution within the distribution loop.
- Sprinkler system (for fire safety).
- Electrical monitoring system. The BMS may monitor the consumed electrical power and the state of main electrical switches.

Figures 6.23 and 6.24 show the main components of BMS systems. The principle of the BMS system's main unit is to connect all components in one field device, compound all parameters in database and check the data quality for air, temperature, and humidity inside the building. Building management systems (BMS) and facilities management systems (FMS) can work together to use the Internet / Intranet – web-based access (including database integration) and the integration of BMS and FMS. These should be addressed for accessing BMS remotely via Internet, integrating control networks using the Internet protocols and infrastructures, and using Internet / Intranet for building facilities management (Wang & Xie, 2002).

### Typical System Components – Field Devices

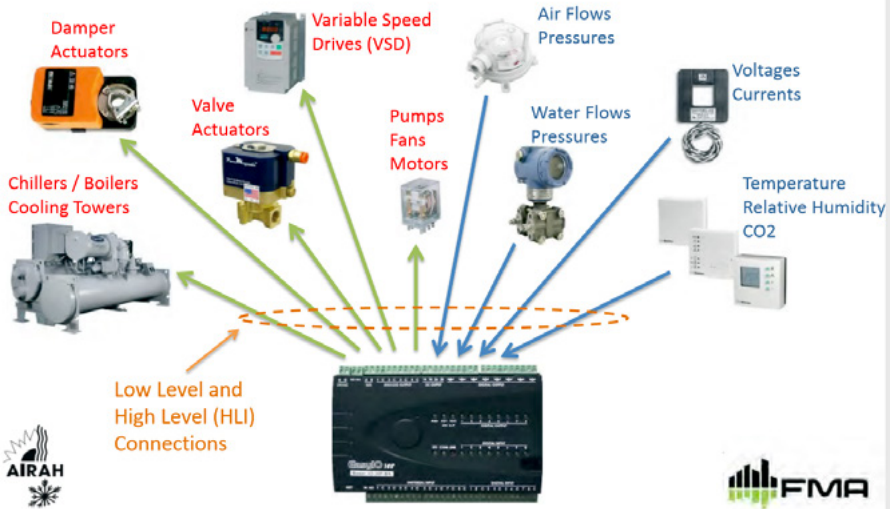


Fig. 6.23. BMS system's components – field device example (City of Melbourne, 2020).

### Typical System Components - Networks

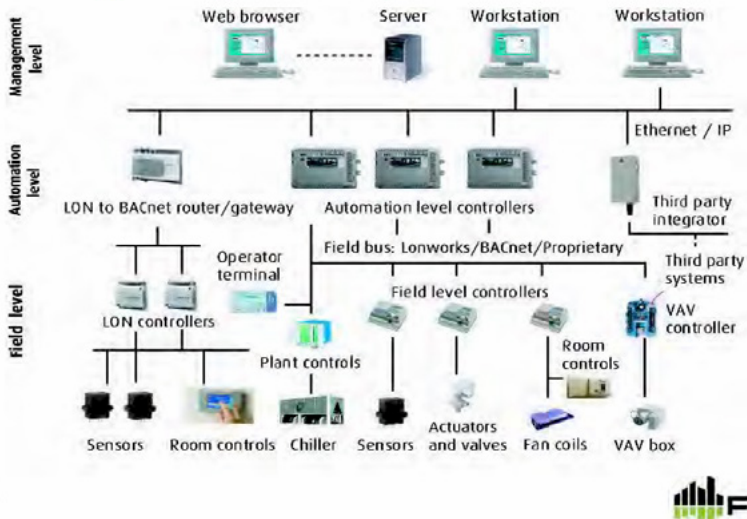


Fig. 6.24. BMS system's components – network example (City of Melbourne, 2020).

## How to use BMS systems for public wood buildings?

---

The main components for controlling the public wooden buildings are temperature, air conditions and humidity. All these components are working together. If a building does not have good ventilation, the humidity will go up and wooden construction will start the process of spoil. If the temperature goes up, the humidity will go down and again wooden construction will start the process of spoil. Wooden buildings need to maintain water and air combination in long term. Wooden construction features have very high fire hazard possibilities in low temperature of the fire. There are several ways to protect wooden surfaces against fire, and using fire retardant products is one of them. Wooden panels and boards treated with fire retardant products are used in residential buildings, nursery homes, schools and other public buildings which are typically occupied by many people simultaneously (Tikkurila, 2020).

All previous building components are possible to control using simple or complicated BMS systems to connect sensors.

### 6.3.3. GIS Systems as Building Management System

---

Geographic information system (GIS) technology manages infrastructure both outside and inside of buildings to provide full operational awareness. It is used to optimize existing space, move staff efficiently and map asset conditions. Throughout the facility life cycle, GIS supports you in your mission, from site selection to space planning and maintenance, lease management and usage, safety issues, and continuity planning. GIS gives organizations a look at their facilities across all scales using the same data and software, allowing them to analyse dependencies, decrease costs, make better decisions, and improve performance management. GIS is a robust information system that supports a diverse set of analytic capabilities, workflows, and applications. Figure 6.25 describes the main feature elements of GIS.

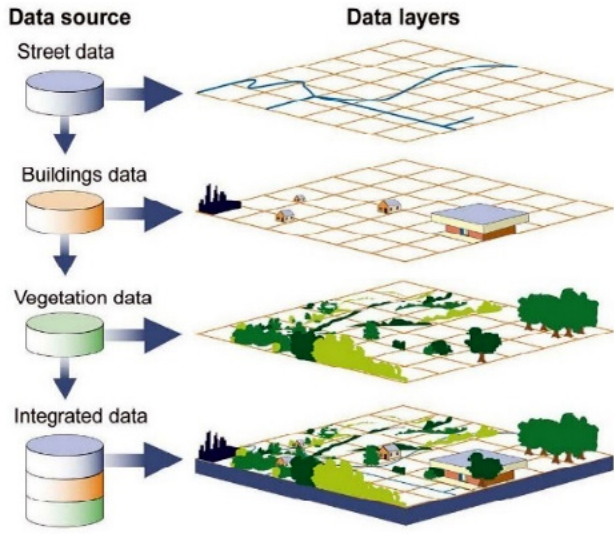


Fig. 6.25. GIS features (National Geographic, 2017).

## 3D GIS for building management

3D GIS is adding a third dimension by adding height (coordinate  $z$ ) to two dimensional (coordinates  $x$  and  $y$ ) creating a 3D plane or feature. It is inherited strongly from the 2D (two dimensional) GIS, yet it has its own unique characteristics. It includes terrain visualization, cityscape modeling or virtual reality and analysis of complex spatial data. The main components of 3D GIS are: 3D data capture, 3D visualization and 3D modeling and management (Al-Ansari et al., 2014). Figure 6.28 visualizes the building's volume from 3D GIS systems. 3D GIS system gives possibilities to integrate and show the results from BIM, reality view and maintenance databases in one platform.

## BIM and GIS integration

GIS data is one of the ways to connect the maintenance object in the building with maintenance data results.

BIM and GIS integration are the process of blending the BIM model into layers of the geospatial context. Designers can use GIS to get the most accurate

information about some areas where construction is to take place. If the area is prone to flooding, designers will learn about it and influence a structure's construction materials, orientation, location, etc. (Andrews, 2019; Bortolini et al., 2016).

BIM data is closely tied to designing and constructing a specific object, structure, or shape. By combining the two, you get the capability to build any structure at an object level.

GIS adding makes the entire picture bigger by adding a smarter and larger environment context, meaning that the object will become a part of the roads, utilities, and land in that environment (Zhang et al., 2009).

Although the main functionality of both BIM and GIS is to create digital representation of the real world, they are different in many ways. They have been developed as solutions to different problems in different domains: the former optimized for the modelling of new, but well-defined objects; the latter for the re-construction of existing objects about which only sparse and incomplete information is available. In comparison, BIM is used at a relatively micro level of the real world, e.g. buildings, and handles mainly 'indoor' data. GIS, on the other hand, is used at a macro level of the real world, e.g. terrain, river, land parcels, and focuses on 'outdoor' data. Therefore, GIS uses geographic coordinate systems and world map projections, while BIM coordinates are relative to the object being modelled and are not usually relative to any place on earth (Zhang et al., 2009).

Traditionally the information in a GIS is paired with two dimensional points, lines and polygons, while in BIM the objects are linked to three dimensional solids and surfaces.

Information about many factors that are related with building asset management has to be brought into consideration to support activities in the process. The factors are not only coming from economic perspective but also social and environmental perspectives. The modelling of these complex systems goes beyond the drawing part of the problem into the simulation, budgeting, environmental impact analysis and decision support. This makes a strong case for a tighter integration of GIS and BIM in a full three-dimensional environment (Zhang et al., 2009).

Integrating GIS and BIM data allows design and construction companies to collect accurate and valuable data that will lead to much more effective and efficient design and project management (Victor, 2020). Figures 6.26 and 6.27



show main integration parts between BIM and GIS. We can migrate BIM features to GIS features and store existing building models and attributes data. GIS systems visualize BIM data together with other spatial layers and give maintenance analysis possibilities to connect attributed data from the building maintenance works.

GIS and BIM advantages:

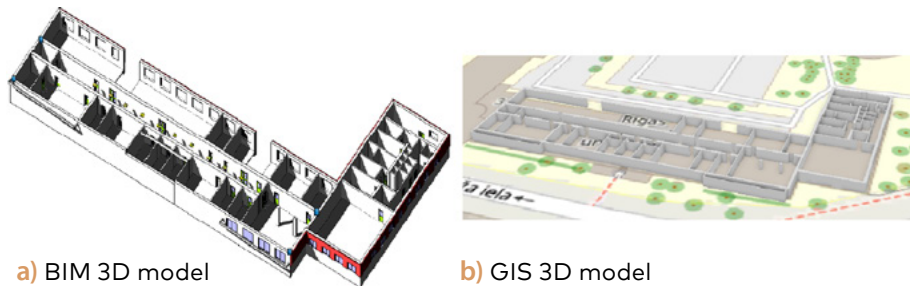
- 3D spatial model;
- attribute data;
- analysis of possibilities;
- dynamical data.

GIS and BIM disadvantages:

- problems related to big data;
- BIM models are very complicated.



Fig. 6.26. BIM-GIS integration (Victor, 2020).



a) BIM 3D model

b) GIS 3D model

Fig. 6.27. BIM and GIS integration example (developed by authors).

### 6.3.4. Data Management Systems for Buildings

---

The database system of building management process is one of the ways to store information and data obtained during the implementation of the maintenance plan.

A lot of the data are obtained in building maintenance processes:

- annual building surveys;
- various repair and maintenance works;
- service works;
- other works.

Relational database management systems are used mostly for data collection. A relational database management system (RDBMS or just RDB) is a common type of database whose data is stored in tables. The most used databases in businesses these days are relational databases, as opposed to a flat file or hierarchical database (Bakuya, 1997).

A Relational Database Management System (RDBMS) is a database management system based on the relational model introduced by E. F. Codd. In relational model, data is stored in relations (tables) and is represented in a form of tuples (rows).

RDBMS is used to manage a relational database. Relational database is a collection of organized set of tables related to each other from which data can be accessed easily. Relational database is the most used database these days. Relational database model – a table, is a collection of data elements organized in terms of rows and columns. A table is also considered as a convenient representation of relations. But a table can have duplicate rows of data, while a true relation cannot have duplicate data. Table is the simplest form of data storage.

Benefits of relational databases:

- Manageability: an RDB is easy to manipulate; each table of data can be updated without disrupting others.
- Flexibility: if you need to update your data, you only must do it once – so no more having to change multiple files one at a time.
- Avoid errors: there is no room for mistakes in a relational database because it is easy to check for mistakes against the data in other parts of the records.

The most popular database management systems are SQL database systems. SQL (pronounced ‘ess-que-el’) stands for structured query language. SQL is



used to communicate with a database. According to ANSI (American National Standards Institute), it is the standard language for relational database management systems. SQL statements are used to perform tasks such as update data on a database or retrieve data from a database. Some common relational database management systems that use SQL are: Oracle, Sybase, Microsoft SQL Server, Access, Ingres, etc. Although most database systems use SQL, most of them also have their own additional proprietary extensions that are usually only used on their system. However, the standard SQL commands such as ‘Select’, ‘Insert’, ‘Update’, ‘Delete’, ‘Create’, and ‘Drop’ can be used to accomplish almost everything that one needs to do with a database. Figure 6.28 shows the main working principle of the database management system (Sisense, 2020).

Figure 6.29 reflects the database management system.

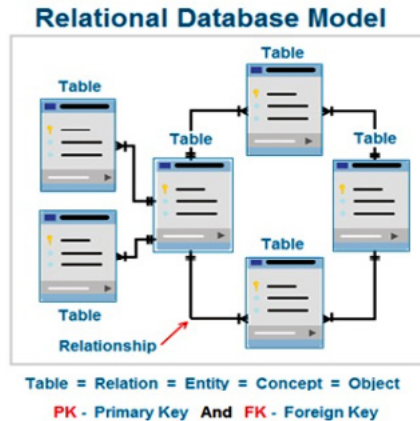


Fig. 6.28. Principle of the relational database model (Learn Computer Science, 2020).

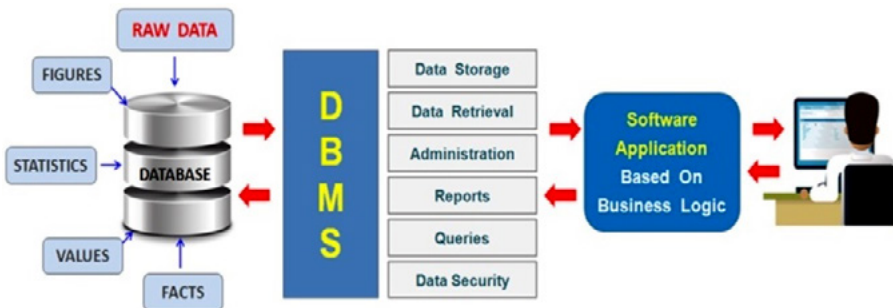


Fig. 6.29. DBMS database management system (Learn Computer Science, 2020).

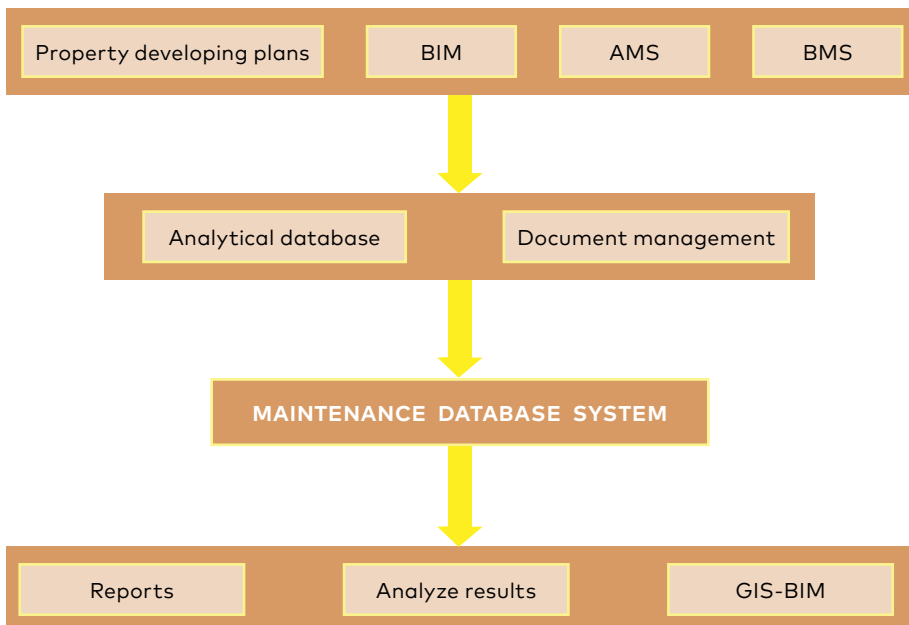
## Content of the database for management purposes

The main tasks of database management are:

- capture data (raw data);
- store data;
- analyse data;
- show results;
- premature decisions.

Figure 6.30 shows the principal schema from data capture to show results.

Databases include all types of data: textual, numerical, file storage, GIS data, BIM data. It is not possible to store all these data in a traditional relational database system or GIS system because we are discussing big data formats. For example, raw data have various file formats: point clouds, image data, pdf files and others. The task of the database is to store the main parameters or results and show the reports on the real situation in building maintenance periods. At the same time database stores evidence of building maintenance events and links to raw data. Cloud storages and SQL servers are very good tools for



**Fig. 6.30.** Maintenance database system's principal schema (developed by the authors).

raw data storage. Practically, discussion is about building maintenance system database which includes the results from maintenance works, BMS systems, BIM systems, asset management systems (AMS) and property developing plans (Fig. 6.30).

## Conclusion

---

There are many different types of data storage – from file management systems to high-level SQL systems. In building management, it is important that all events that take place in a building are recorded to track the important stages of building maintenance that are determined by building maintenance processes. The chapter covered – BIM, BMS, GIS and DBMS, which are more widely used platforms to store data from sensors, information from building design solutions and results from building monitoring and their interaction in determining the tasks required for building maintenance.

## 6.4. MAINTENANCE MANAGEMENT PLAN

---

***Maris Kalinka,***

Institute of the Civil Engineering and Real Estate Economics,  
Riga Technical University

***Ineta Geipele,***

Institute of the Civil Engineering and Real Estate Economics,  
Riga Technical University

***Janis Zvirgzdins,***

Institute of the Civil Engineering and Real Estate Economics,  
Riga Technical University

---

Building maintenance policy is a written document that provides a management framework to the maintenance personnel to determine appropriate maintenance strategy and standard. Building maintenance policy and strategy is one of the main aspects in management of building maintenance operation processes (Lee & Scott, 2009).

Maintenance policy is a tool for maintenance personnel to plan their appropriate maintenance strategies (Donnelly, 2007; Shen, 1997; Al-Zubaidi, 1997). However, before a maintenance plan is prepared, maintenance personnel and top management are required to agree on maintenance policy because it requires strategic directions as well as resources. The maintenance policy consists of five major components and different maintenance strategies which are developed from these components. Without defining this policy, maintenance operation processes will be in a random order. The five major components (RICS, 1990; Chanter & Swallow, 2008) are as follows:

- the length of time for maintaining their present use;
- the life requirements of the buildings and their fittings and services;
- the standard to which the building and its services are to be maintained;
- the reaction time required between a defect occurring and a repair being carried out;
- the legal and statutory requirements shall also be considered.

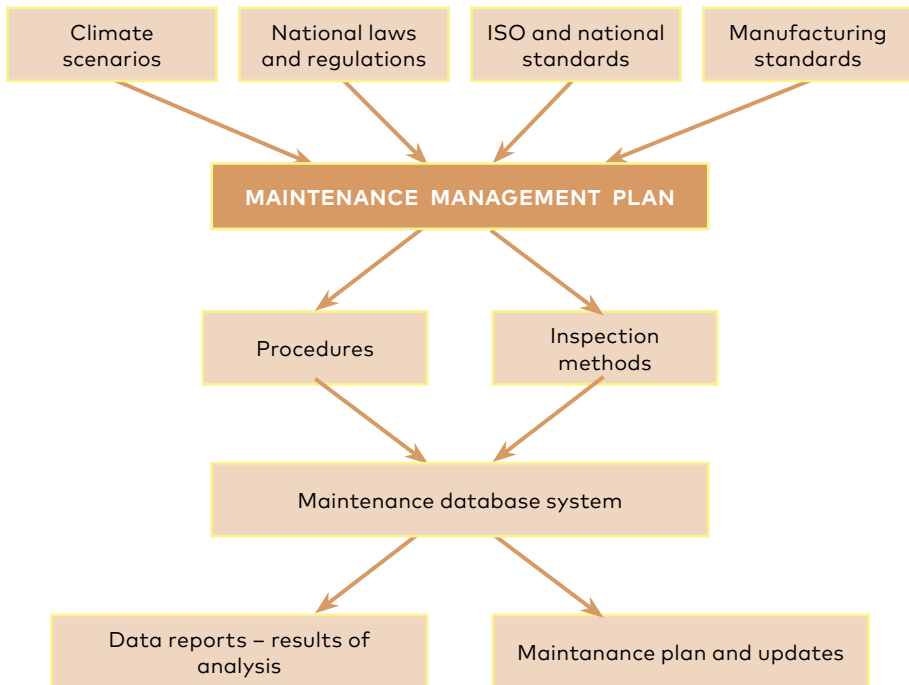
Maintenance plan is one part of the life cycle which describes how to manage the building. Maintenance plan is different for simple buildings, but it includes three main parts:

- maintenance procedure manuals;
- inspection methods;
- maintenance period.

Figure 6.31 reflects the framework of maintenance plan.

## Development of maintenance management plans

While developing the maintenance management plan, experts analyse and determine the type of the public building: museum, office, theatre or other. Maintenance management plan is different for such types of buildings, and it is dependent from the number of visitors.



**Fig. 6.31.** Framework of maintenance plan (developed by authors).

### **Maintenance workflow**

Regular inspection and unplanned control are necessary to assess the condition of a building and report any problems, and decide whether repair or other work is necessary.

There are specific regular tasks, like cleaning of the gutters, to ensure long term service of the building as well as minor repairs, like replacement of broken glass or tile to avoid larger scale damages.

Maintenance differs from repair, which is working to return a building to a good condition on a long-term basis.

Planned and regular maintenance actions must be documented in the maintenance plan. The maintenance plan shall identify each element of the building, like roofs, foundations, walls, etc., demanded maintenance tasks and the frequency. Frequency may depend on the condition of the identified building element and could be:

- **occasional** (after a storm or specific reasons);
- **regular** (for tasks carried out at least once a year);
- **cyclical** (for tasks carried out less than once a year).

Results and findings of all inspections and tests as well as all maintenance works and materials used must be recorded in Maintenance Log. Experts must enter all results in the building management database system and check deviations from government laws and standards which are related to the procedures for the maintenance of the building. There are also specific standards for wooden buildings to save and exploit wood like eco material.

### **Content of maintenance procedure manuals for building management**

The Maintenance Procedure Manual should stipulate the following (Shen, 1997; Rovers et al., 2018):

- Responsibility of qualified inspection agencies, which are hired by facility owners or authorized persons and which implement inspection to diagnose the results of inspection. The diagnosis should be made for each structure and facility. Qualified inspection agencies should record the information on facility selection, inspection items, inspection methods, inspection results and diagnosis into check sheets or database systems.

- Responsibility of facility owners or authorized persons to preserve maintenance records, including the check sheets, during maintenance periods.
- Responsibility of facility owners and authorized persons to hire qualified agencies and implement detailed surveys to formulate repair work plans when serious defects or deterioration such as degradation in function and capacity is detected.
- Inspection of building construction elements is one of the most important parts for understanding and managing the life cycle of buildings.

Maintenance Procedure Manual must include the principle how and when to adjust reports to wood manufacturing standards and government standards. We must understand what we need to check from time to time and how to fix it, if necessary.

### **Types of inspection**

There are several types of inspection: routine inspection, periodic inspection, and unscheduled inspection, which also includes detailed surveys and monitoring of facilities. Framework of the inspection is briefly described below (Heritage Building Maintenance Manual, 2008).

#### *a. Routine inspection*

Routine inspection is a daily inspection to quickly find out any unusual incidents and defects of the building facilities. It generally consists of visual inspections while walking in and around building facilities.

#### *b. Periodic inspection*

Periodic inspection is applied in the following cases: to survey damages including deterioration and defects; to diagnose deterioration and defects; to select the suitable repair methods for light damages and deteriorations.

Also, it should make judgment on the need of a further survey on the heavy damages and deterioration. With this, it is carried out at a fixed interval. The periodic inspection provides base information for the planning of maintenance and repair works.

#### *c. Unscheduled inspection*

Unscheduled inspection is applied in the following cases: to survey and evaluate the effects of unexpected incidents occurring, such as floods, strong wind, fires, and other natural disasters which have impact on building

facilities.

*d. Detailed survey*

Survey and design are applied in the following cases:

- to further specify causes of structural defects and damages;
- to find out the most suitable repair works for the damages;
- to evaluate the performance of repair works;
- to survey unidentified incidents arising after repair works and the final inspection;
- to ensure structural safety when facilities are to be used with greater loading conditions than the design conditions;
- to evaluate structural safety when facilities are to be used more frequently than design periods.

**Inspection methods**

Inspection methods can be selected from the list below. However, it should be noted that design consultants can change inspection methods with explanation, taking in account the scales of building facilities (Lee & Scott, 2009):

- visual inspection;
- operation tests;
- check of embedded pressure gauge;
- check by tapping with a test hammer;
- check by touching;
- check with crack scales;
- check with dossiers of drawings and measurement with steel tapes, etc.;
- check with plummet;
- non-destructive equipment, etc.;
- interlocking function test;
- measurement with a voltmeter;
- measurement with steel tapes, 3D laser scanner, drones, etc.;
- visual inspection and check by touching;
- visual inspection with binoculars, etc., as needed.

The inspection methods can be updated periodically and connected to maintenance plan and procedures. It is recommended that the inspection procedures of construction elements include visual and geometrical methods.



Maintenance tasks are very closely connected with climate scenarios in the region. Climate scenarios are dependent from country and geographical deployment. For example, climate scenarios close to the sea have wind periods in location place.

Occasional and regular tasks including 10 main parts:

- area – foliage and large trees close to walls, slope;
- basement – water leakage, air circulation and exchange;
- rainwater disposal – rainwater goods generally, rainwater goods, below ground drainage;
- external walls – external walls generally, external walls, copings and parapets, ventilation, bird screens, window flashings;
- doors – bird screens, window flashings;
- internal structure – internal spaces generally, internal structure and fabric, exposed woodwork, roof and floor voids, wood constructions;
- attic – attic general, ventilation;
- roof coverings – roof areas generally, connections and parapets, slate and tile roofs, sheet metal roofs and cladding, cleaning of the dirt, nails, amount of the snow;
- building services – lightning protection installation, firefighting equipment, burglar alarm system, emergency notification system, sewer system and water supply, outdoor watering system, heating system general, heating system, stoves.

Tables 6.3, 6.4 and 6.5 show the list of main maintenance tasks and frequencies. These maintenance tasks are divided in groups by building elements. Building element groups include indoor elements and environmental objects. Maintenance tasks include general work description. These works can be done by visual and technical inspection methods. Table 6.4 and 6.5 include the periods and periodical frequencies. The building maintenance plan must include regular update of the tasks, periods, and frequencies.

Table 6.3

Maintenance Tasks (developed by authors from the Department for Environment Food & Rural Affairs (2020), JICA Project Team (2020))

Ref	Building element	Maintenance task
<b>1.</b>	<b>Area</b>	
1.1.	Foliage and large trees close to walls	Check and report any dead branches and signs of ill health or root damage to the building or below ground drainage.
1.2.	Slope	Check and report the slope of the ground around the building for water flowing off walls.
<b>2.</b>	<b>Basement</b>	
2.1.	Water leakage	Check the basement for moisture or leakage.
2.2.	Air circulation and exchange	Check the basement for sufficient air circulation. Provide ventilation of cellars by opening ventilation hatches in spring and close the hatches before winter.
<b>3.</b>	<b>Rainwater disposal</b>	
3.1.	Rainwater goods generally	Inspect rainwater goods from the ground and accessible high points and report any loss or damage.
3.2.	Rainwater goods I	Clear rainwater goods of debris and ensure that overflows are clear. Rod if necessary. Check that stainless steel guards are secure.
3.4.	Perimeter drainage channel	Clear drainage channel from vegetation and debris.
3.5.	Perimeter drainage channel	Inspect drainage channel for cracks and open joints. Seal with appropriate sealant.
3.6.	Below ground drainage	Open up inspection chambers. Check that all gullies and gratings are free from silt and debris and that water discharges freely to the main sewerage or soakaway.
<b>4.</b>	<b>External walls</b>	
4.1.	External walls generally	Inspect external walls from the ground and accessible high points and report any damage, cracks and signs of movement.
4.2.	External walls, copings and parapets	Remove any vegetation, ivy, etc.
4.3.	Ventilation	Ensure that ventilation grilles, air bricks, louvres, etc. are free from obstruction.

Ref	Building element	Maintenance task
4.4.	Bird screens	Check that tower, roofs and windows are bird-proof before nesting starts. Do not disturb bats.
4.5.	Window flashings	Check for leakage and, if necessary, make minor repairs.
<b>5.</b>	<b>Windows</b>	
5.1.	Functionality	Check operation of hinges, bolts and locks and lubricate as necessary. Check security of locks.
5.2.	Window glazing	Inspect windows and make essential minor repairs to glazing.
5.3.	Conditions of the frames	Check the wooden frames for signs of moisture damage, insect infestation and / or rot, cracks and opened joints.
5.4.	Painting of frames	Check the paint of the window frames and repaint if necessary.
5.5.	Glazing sealants	Check the glazing sealants for damages (cracks and loses) and make essential minor repairs.
5.6.	Metal furnishing	Check for missing fastenings, parts and any signs of rust. Make essential minor repairs.
5.7.	Leaded light windows	Inspect lead frames, putty, glass and wire ties and report any problems. Clear condensation drainage channels and holes.
<b>6.</b>	<b>Doors</b>	
6.1.	Functionality	Check operation of hinges, bolts and locks and lubricate as necessary. Check security of locks.
6.2.	Paint / Varnish	Check the paint / varnish of wooden parts and repaint if necessary.
6.3.	Conditions of the frames and sashes	Check the wooden parts for signs of moisture damage, insect infestation and / or rot, cracks and opened joints.
6.4.	Metal furnishing	Check for missing fastenings, parts and any signs of rust. Make essential minor repairs.
<b>7.</b>	<b>Internal structure</b>	
7.1.	Internal spaces generally	Inspect roof voids and internal spaces, particularly below gutters. Report on any evidence of roof or gutter leaks.
7.2.	Internal structure and fabric	Inspect internal structure and fabric, including roof timbers and bell frames, and report on any signs of structural movement or damp, fungal growth and dry rot.

Ref	Building element	Maintenance task
7.3.	Exposed woodwork	Inspect exposed woodwork and surfaces below for signs of active beetle infestation. Report any beetles or fresh wood dust.
7.4.	Roof and floor voids	Check roof and floor voids, inspect for signs of vermin and remove. Avoid using poison when bats are roosting.
7.5.	Internal spaces generally	Ventilate the building.
<b>8.</b>	<b>Attic</b>	
8.1.	Attic general	Check the attic and roof ventilation, check for condensation.
8.2.	Ventilation	Provide ventilation of the attic.
8.3.	Wood constructions I	Check the wood construction for signs of moisture damage, insect infestation and / or rot.
8.4.	Wood constructions II	Check the wood construction for cracks, opened joints or pins for pull-out.
<b>9.</b>	<b>Roof coverings</b>	
9.1.	Roof areas generally	Inspect roof areas from the ground and accessible high points and report any loss or damage to the roof coverings.
9.2.	Connections and parapets	Check roof joints and chimney connections for damage.
9.3.	Slate and tile roofs	Inspect for cracked, displaced and broken slates and tiles. Replace to match.
9.4.	Sheet metal roofs and cladding	Inspect condition of panels, joints and clips. Make temporary repairs to cracks and splits.
9.5.	Cleaning of the dirt	Cleaning dirt, moss leaves, vegetative matter and mildew.
9.6.	Nails	Checking the nails that attach the shingles to the roof for corrosion and pullout.
9.7.	Amount of snow	Clean the roofs from snow.
<b>10.</b>	<b>Building Services</b>	
10.1.	Lightning protection installation	Visually inspect the lightning conductor system, including spikes, tapes, earth rods and all connections and fastenings.
10.2.	Fire-fighting equipment	Service fire extinguishers.
10.3.	Burglar alarm system	Test the system and visually inspect wiring. Qualified engineer to service alarm.
10.4.	Emergency notification system	Test functionality of the system.

Ref	Building element	Maintenance task
10.5.	Sewer system and water supply	Ensure that all exposed water tanks, water pipes and sewer system are protected against frost.
10.6.	Sewer system and water supply	Check that water tanks, pipes and radiators do not flow.
10.7.	Sewer system and water supply	Check for leakage in the sewer system for cleaning of inspection holes.
10.8.	Outdoor watering system	Check if outdoor watering systems are switched off.
10.9.	Heating system general	Service the heating system and update the service schedule.
10.10.	Heating system	Ensure that all heating pipes are protected against frost.
10.11.	Chimneys	Clean the chimneys.
10.12.	Stoves	Check the condition of heating stoves, stoves and chimneys for cracks with soot.
10.13.	Temperature and humidity	Record temperature and humidity in different parts of building.

Table 6.4

Frequency of Maintenance Tasks by Month (developed by authors)

Ref	Building element	Frequency	J	F	M	A	M	J	J	A	S	O	N	D
<b>1.</b>	<b>Area</b>													
1.1.	Foliage and large trees close to walls	Annually						x						
1.2.	Slope	Annually			x									
<b>2.</b>	<b>Basement</b>													
2.1.	Water leakage	I After stormy weather												
		II Twice per year			x							x		
2.2.	Air circulation and exchange	I Annually							x					
		II Twice per year			x						x			
<b>3.</b>	<b>Rainwater disposal</b>													
3.1.	Rainwater goods generally	I during / after stormy weather			x									
		II Annually												
3.2.	Rainwater goods I	Twice per year					x						x	
3.3.	Rainwater goods II	Twice per year					x						x	
3.4.	Perimeter drainage channel	Monthly, spring and summer			x	x	x	x	x	x	x			
3.5.	Perimeter drainage channel	Twice per year					x						x	
3.6.	Below ground drainage	Twice per year					x						x	
<b>4.</b>	<b>External walls</b>													
4.1.	External walls generally	I After stormy weather			x									
		II Annually												
4.2.	External walls, copings, and parapets	Annually											x	
4.3.	Ventilation	Twice per year			x						x			
4.4.	Bird screens	Annually			x									
4.5.	Window flashings	Annually								x				
<b>5.</b>	<b>Windows</b>													
5.1.	Functionality	Twice per year			x							x		

Ref	Building element	Frequency	J	F	M	A	M	J	J	A	S	O	N	D
5.2.	Window glazing	Twice per year				x								x
5.3.	Conditions of the frames	Annually								x				
5.4.	Painting of frames	Once per year				x								
5.5.	Glazing sealants	Once per year				x								
5.6.	Metal furnishing	Annually				x								
5.7.	Leaded light windows	Annually				x								
6.	Doors													
6.1.	Functionality	Twice per year				x							x	
6.2.	Paint / varnish	Once per year											x	
6.3.	Conditions of the frames and sashes	Annually								x				
6.4.	Metal furnishing	Annually				x								
7.	<b>Internal structure</b>													
7.1.	Internal spaces generally	I During / after stormy weather II Annually						x						
7.2.	Internal structure and fabric	Annually						x						
7.3.	Exposed woodwork	Annually						x						
7.4.	Roof and floor voids	Annually						x					x	
7.5.	Internal spaces generally	Monthly on dry days						x	x	x	x	x		
8.	<b>Attic</b>													
8.1.	Attic general	Twice per year				x								x
8.2.	Ventilation	Monthly on dry days												
8.3.	Wood constructions I	Annually											x	
8.4.	Wood constructions II	Annually											x	
9.	<b>Roof coverings</b>													
9.1.	Roof areas generally	I After stormy weather II Annually												x

Ref	Building element	Frequency	J	F	M	A	M	J	J	A	S	O	N	D
9.2.	Connections and parapets	I After stormy weather II Annually												
9.3.	Slate and tile roofs	I After stormy weather II twice per year			x								x	
9.4.	Sheet metal roofs and cladding	Twice per year					x						x	
9.5.	Cleaning of the dirt	Annually								x				
9.6.	Nails	Annually								x				
<b>10.</b>	<b>Building Services</b>													
10.1.	Lightning protection installation	Annually						x						
10.2.	Fire-fighting equipment	Annually									x			
10.3.	Burglar alarm system	Annually										x		
10.4.	Emergency notification system	Annually					x							
10.5.	Sewer system and water supply	Annually									x			
10.6.	Sewer system and water supply	Annually									x			
10.7.	Sewer system and water supply	Annually									x			
10.8.	Outdoor watering system	Annually									x			
10.9.	Heating system general	Annually					x							
10.10.	Heating system	Annually									x			
10.11.	Chimneys	Annually									x			
10.12.	Stoves	Annually									x			
10.13.	Temperature and humidity	Every day												



Table 6.5  
Frequency of Maintenance Tasks (developed by authors)

No.	Building element	Maintenance task	Frequency
1.	Rainwater goods	Repaint	7 years
2.	Timber parts	Repaint	7 years
3.	Doors and window frames	Repaint	7 years
4.	Wiring and electrical installations	Inspect all wiring and electrical installations in accordance with regulations and perform the testing, including all wiring and electrical equipment associated with building and all portable electrical equipment	10 years

## Conclusion

Maintenance is a very dynamic process. Maintenance plan must be updated periodically. Periodical updates depend on the lifecycle of the building – renovation process and repairs must be included in maintenance procedures. The whole maintenance process must be reported and analysed. Building maintenance requirements cannot be fixed but are based on the procedures that are based on regulatory requirements, national standards and factory requirements. The procedures need to be regularly reviewed and updated based on survey results. Combining the procedures with the building maintenance database, it is possible to fully trace the physical condition of the building and the stability of the structures. The main tasks of the maintenance are ensuring the safety of people and wooden constructions.

## 6.5. MAINTENANCE AND REPAIR WORKS

---

***Laura Tupenaite,***

Department of Construction Management and Real Estate,  
Vilnius Gediminas Technical University

***Mindaugas Krutinis,***

Study and Consulting Center

---

All elements of a building are subject to deterioration over time. Timber structures can undergo alteration during their service life, which can be caused by mechanical, environmental or biological agents (bacteria, insects and fungi) because of the biological nature of the material (Sandak et al., 2015).

Deterioration due to aging cannot be eliminated, but good design, workmanship and appropriate maintenance can slow the rate of deterioration. Some of the preventive measures, maintenance strategies, repair and replacement works applied in wooden buildings are described in this chapter.

### 6.5.1. Maintenance

---

Maintenance needs to be considered at the design stage. When deciding on the quality of elements and fittings that will be specified for a newly designed structure, a designer frequently chooses between items that have relatively high initial costs and low ongoing maintenance requirements and items that are cheaper to purchase but may have more onerous maintenance requirements. In some design briefs, the designer is called upon to devise a maintenance schedule for the completed structure. Table 6.6 gives a list of the items that may need to be considered when drawing up a maintenance schedule (Wood Solutions, n.d.).

Table 6.6

Maintenance and Inspection Periods for Wooden Buildings (adapted from Wood Solutions, n.d.)

Item	Maintenance or inspection period	Remarks
Finishes <ul style="list-style-type: none"> <li>• internal</li> <li>• external</li> </ul>	≈10 to 15 years	
Cleaning	Clean non-confined surfaces as required. Remove build-up of soil against timber near to ground.	Dirt, mould, etc. traps moisture, increases potential for decay.
Cladding <ul style="list-style-type: none"> <li>• roofing, weatherproofing</li> </ul>	≈10-year inspections. Some environments may make inspection of weatherproofing more frequent.	Timber cladding can have design life (5 to 100 years).
Termite protection <ul style="list-style-type: none"> <li>• physical barriers</li> <li>• chemical barriers</li> </ul>	Inspect annually or in accordance with standards. ≈10 years for maintenance of barrier. As required by supplier (≈2 to 20 years).	Any sign of termites / other insects should prompt action.
Ventilation <ul style="list-style-type: none"> <li>• subfloor, wall, roof</li> </ul>	Check that vents are not blocked annually or after any new work. Clean as required in ≈10 years.	Vents are essential to prevent build-up of moisture / condensation.
Vapour barriers <ul style="list-style-type: none"> <li>• subfloor, roof</li> </ul>	Check integrity each ≈15 years or after any new work or other maintenance in the area.	
Metal fasteners <ul style="list-style-type: none"> <li>• integrity</li> <li>• corrosion</li> </ul>	Retighten bolts, screws and repunch nails if required after 6 months and one year if unseasoned timber is used. Check at intervals dependent on type of corrosion protection used. Inject water repellents for bolts.	Replace any suspect fasteners.  Hot dipped galvanised fasteners solve many corrosion problems.
Plumbing	Inspect gutters, downpipes, etc. each 10 years. Repair any plumbing if a leak is noticed.	Moisture accelerates decay and deterioration.
Decay	Check at the same time as connections. Repair or replace as soon as any decay is noticed.	
End-grain <ul style="list-style-type: none"> <li>• sealants / caps</li> </ul>	Inspect each 3–5 years. Replenish as required by manufacturer and before repainting.	

All wood is susceptible to decay; however, the rate of deterioration varies depending on the species. Factory applied preservative treatment, as opposed to field applied treatment, provides the most reliable protection. Alkaline copper quat (ACQ), copper azole (CA) and chromated copper arsenate (CCA) type preservatives are suitable for exposed exterior conditions, while borate type preservatives are only suitable for situations protected from continuous exposure to liquid water. Only preservative treated wood that has been incised (small slots created in the sides of the wood so that preservative chemicals can penetrate more deeply) should be used when placed in contact with soil. Field cuts, notches and holes should be treated with preservatives specifically intended for field cuts, as they are formulated to soak into the wood and penetrate well through the end grain (Homeowner Protection Office, n.d.).

Table 6.7 gives guidance on the maintenance of paints and stains for exterior surfaces. There are significant differences in the expected life of the various coating systems, and these can influence the type of coating system selected. Note that clear finishes have a much shorter life than opaque finishes (Wood Solutions, n.d.).

Table 6.7  
Maintenance of Paints and Stains for Exterior Surfaces  
(Wood Solutions, n.d.)

Finish	Appearance of wood	Initial treatment		Maintenance of surface finish		
		Coats	Cost	Procedure	Period	Cost
Paint	Grain and natural colour obscured	Prime and two top coats	Medium to high	Clean and apply top coat or remove and repeat initial treatment if required	7–10 years	Medium
Clear	Grain and natural colour unchanged if adequately maintained	Four coats (minimum)	High	Clean and stain bleached areas and apply two more coats	2 years or when breakdown begins	High
Water repellent	Grain and natural colour – visibility becoming darker and rougher textured	One or two coats of clear material, or preferably dip applied	Low	Clean and apply sufficient material	1–3 years or when preferred	Low to medium
Stains	Grain visible, coloured as desired	One or two brush coats	Low to medium	Clean and apply sufficient material	3–6 years or when preferred	Low to medium
Organic solvents preservatives	Grain visible, coloured as desired	Pressure, steeping, dipping, brushing	Low to medium	Brush down and reapply	2–3 years	Medium
Waterborne preservatives	Grain visible, greenish, fading with age	Pressure	Medium	Brush down to remove surface dirt	None unless stained, painted or varnished	–

## Protection against moisture

---

The key to the durability of timber has already been identified as ‘keeping it dry’. Most of the maintenance requirements outlined in Table 6.6 lead to the exclusion of moisture from timber.

Exterior wood elements come in contact with moisture through exposure to rain or ground water. A third possible form of exposure to moisture, ambient exterior humidity, does not cause exposed wood to reach the required high moisture content levels that would allow deterioration to occur.

Whenever possible, it is recommended that exposure to moisture be eliminated or minimized. Many exterior wood elements can be protected from wetting by roofs or metal flashings. Sloping of horizontal wood surfaces for positive drainage and detailing that allows drying are some other ways to limit the time that moisture stays in contact with the wood (Homeowner Protection Office, n.d.).

Exposure to moisture may also be limited by the application of coatings such as paints or stains. However, their use must be carefully considered, as some coatings will also restrict drying of the wood structure in the event that water unintentionally penetrates past the coating at some location. There are almost always breaks in the coating caused by the seasonal expansion and contraction of the wood with changes in humidity levels. If the wood is not coated before assembly, there may also be portions of the structure that have not been reached during coating application, e.g. inaccessible surfaces at connections (Homeowner Protection Office, n.d.). Painting will provide the greatest degree of protection.

Coatings are generally composed of three components: solvent, pigment and binder. The solvent thins the pigment resin mixture to application consistency. Pigment provides the colour and gloss adjustment. The binder, or resin, binds the pigment particles together and adheres the film to a surface, giving the paint durability and adhesion. Coatings are classified according to their binder, typically: alkyd, latex, acrylic, epoxy or urethane. The type of binder plays a large factor in the performance of the coating. However, the type and amount of pigment in a coating will also significantly affect its performance (Homeowner Protection Office, n.d.).

The performance and durability of coatings is dependent on many factors besides the basic paint composition and quality of application. Surface

preparation and compatibility between substrate and coating are critical to the durability of the coating (Homeowner Protection Office, n.d.).

There are several factors to consider that can impact a coating recommendation and the final outcome. When determining the appropriate coating and maintenance interval, it is important to look at the wood species / substrate, its expected exposure, and whether it will be used for an interior or exterior application. Based on this starting point, the impact of weathering and biological/physical factors such as UV exposure, humidity, exposure to traffic/human touch or pollutants, and temperature range can be evaluated. Nevertheless, the type of wood and the conditions it will be exposed to in situ are only part of the equation. Coatings must also be properly applied (Bos, 2018).

In factory settings, undercoats and topcoats can be applied under exacting conditions with temperature and humidity controls, and an easier ability to ensure sufficient product is applied to achieve the desired coating thickness. Increasingly, mass timber manufacturers are applying all coats in the factory and delivering the product prefinished for on-site installation (Bos, 2018).

Sometimes, only the undercoat (or primer) will be applied in the factory with subsequent topcoats applied on-site. Selecting the right undercoat to apply to all six sides of a CLT or glulam piece is critical to garner all the benefits of protection and ensure the successful, subsequent topcoat application. Absorption of the undercoat enhances the stability of wood components and increases topcoat performance, so it is imperative that the undercoat allows subsequent topcoats to sink in and penetrate the wood for optimal performance. An effective undercoat also protects the pieces from moisture intrusion in transit and during construction, especially on the all-important end grain. It also helps control finish clarity, colour, and grain definition while offering deep wood protection against UV damage and moisture (Bos, 2018).

Sometimes the design intent is to keep the wood as natural as possible; other times there is a desire to play with colour to make designs come alive. When comparing coatings such as natural, translucent, or opaque, the tint load is an important consideration. With lighter-toned woods, where a natural look is desired, it is often necessary to fine-tune transparency. In general, the stronger the colour system, the greater the UV blockage (Bos, 2018).

According to Bos (2018), designers should take the following things into consideration when selecting a coating product: environmental performance,

ability to penetrate wood, ultra-low VOC profile, ability to customize tone, overall performance, and ease of maintenance. Increasingly, specifications also need to consider regulations surrounding fire retardancy.

## Protection against insects

---

Wood-damaging insects are insects that damage wood by tunneling through it to live, nest, or feed. There are a number of insects that cause damage to wood, among the most dangerous are termites (Fig. 6.32).

During construction and maintenance phases the importance of protecting timber buildings or elements against pest infestation should not be underestimated. When used correctly, preservatives offer professional and reliable timber protection, thus helping avoid the potential complications and costs connected with repairing infested timber in future. After all, painting, spraying or dipping is often used (Bochemit, 2020).



**Fig. 6.32.** Destruction of wood by termites (DC Scientific Pest Control, n.d.).



## Protection against fungi

---

Wood becomes susceptible to fungal infestation under specific environmental conditions, i.e. moisture content above 20 %, oxygen availability and a temperature between 15 and 45 °C. Fungal deterioration affects then mainly outdoor wooden structures, reducing wood mechanical and aesthetical properties, and significantly limits its service life (Zabel & Morrell, 2012).

A broad range of effective synthetic wood preservatives has been applied to prevent this, including copper-based agents (i.e. chromated copper arsenate), triazoles (azaconazole, propiconazole, tebuconazole), pentachlorophenol or boron-based fungicides. Due to environmental and health concerns, however, many of them have been banned from the use, creating the need for developing alternative wood protection agents and methods based on non-toxic natural products (Broda, 2020).

Nowadays, environmentally-friendly wood protection is an object of extensive research. Exposure to fungal spores that develop into fungi cannot be avoided, as the spores are found everywhere. These spores will germinate and grow if the following four requirements are present (Homeowner Protection Office, n.d.):

- oxygen;
- mild temperatures;
- moisture;
- suitable food (the wood).

For exposed wood structures, control over oxygen and temperature is not possible. However, control over the other two requirements is possible. Eliminating either one of these requirements will eliminate the potential for fungal growth and decay (Homeowner Protection Office, n.d.).

Since the growth of wood-degrading fungi depends on water availability, one of the methods is moisture control using natural hydrophobising agents, such as resins and waxes of plant or animal origin, or plant oils (González-Laredo et al., 2015; Broda, 2020). Another approach for extending the service life of wood is the utilisation of natural compounds with biocidal properties and fixing them inside the wood structure (González-Laredo et al., 2015; Broda, 2020). The more innovative method involves using biological control agents, i.e. microorganisms such as other fungi and bacteria which act as antagonists to wood-decaying fungi (González-Laredo et al., 2015; Broda, 2020).

## 6.5.2. Repair and Replacement

---

Building owners, maintenance personnel and employees are often in a position to notice certain conditions that can lead to timber repairs. Cracks in ceiling or wall materials, sagging ceilings or floors, and loose ceiling tiles or panels that show enlarged gaps can all be early signs of distress. There are many conditions that can result in the need for the evaluation of a structure (Western Wood Structures, 2020):

- As older structures change ownership or building usage, remodelling can increase loads to the structure which can require upgrading. These loads may result from multiple layers of roofing, roof over-builds, installation of additional mechanical equipment such as HVAC units, suspended ceilings, and attic storage.
- Over time, structural timber elements may experience decay which ultimately requires repair. This can occur due to a penetration of the roof or walls that creates water leaks, or from improper ventilation of an area with increased moisture, including swimming pools or steam-emitting machinery.
- Forklift impacts to wood structural members which can occur in timber structures used as warehouses.
- Deficiencies in the original design.
- Improper connection details to wood structural members.
- Isolated weather events that exceed loading capacity, including ice or rain on top of a snow load, or clogged roof drains that allow water to pond on the roof.
- Repairing failed structural timbers is, of course, not a new practice. For centuries repairs have been fashioned using carpentry methods or with blacksmith-made splints, brackets and ties (Russell, 2020).

In more recent times modern materials were utilised, such as steel, epoxy resins, carbon fibre rods and wire rope, to reinforce structures. Building repairs can also be affected by completely replacing timbers with new timber or, where used appropriately and sympathetically, materials such as steel or reinforced concrete. It may also be possible to reduce the loads through the design of secondary structures and in-fills such as brick panels, or packing-up under partly decayed timbers (Russell, 2020).

The form of repair largely depends on the situation. Although there is no right or wrong method, there is always a solution that is most appropriate to

the circumstances presented by the building. In choosing the right approach and repair mechanism one must take all the evidence into account, including the type of failure that has been observed and, by deduction, the reason for it. Often these observations, decisions and design solutions are the realm of specific professional consultants, such as structural engineers or building surveyors (Russell, 2020).

The repair services may include (Russell, 2020):

- replacement of broken members;
- strengthening or stiffening of existing members;
- installing shear dowels in failed structures;
- post tensioning beams and timber trusses.

The complete removal and replacement of a failed timber member should be the last solution. Where the structure is concealed (as in a wall or roof space), a new member can be inserted beside the old one, or the old member can be patched with timber or strengthened by attaching steel bracing. Where members are patched with timber, the strength of the joint is critical. The traditional scarf joint will resist most stresses in rafters, posts or beams, while a simpler halved joint can be used in wall plates. If the joint will be exposed to view, bolts can be concealed behind timber plugs (NSW Heritage Office, 2004).

Steel reinforcement can also be used with timber members. It may consist simply of steel plates either side of a member (or top and bottom), bolted through the timber. A method sometimes used for overstressed beams is to convert them to trussed girders by adding steel struts and tension rods underneath. Where space is not available for this, a variation using side rods is possible (NSW Heritage Office, 2004).

In Denmark, the civil engineering office of Eduard Troelsgård has introduced an approach to the repair of timber structures, where decayed wood is replaced by splicing in new, seasoned wood, and craftsmen work with contemporary tools and techniques. They base their repairs on solutions that resemble old methods; decayed parts are replaced in a way familiar to today's carpenters while still rooted in tradition (Larsen & Marstein, 2016).

A second approach is to introduce new elements for the reinforcement of the old structure. In freely-supported structures, like roofs, various reinforcement techniques using supports and additional elements have been widely used. In many cases, best be fulfilled by reinforcing the weakened structural

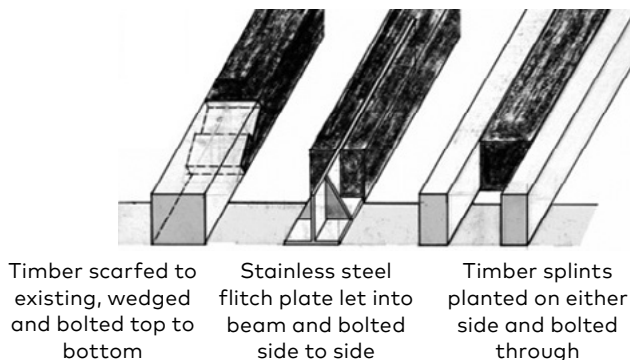
element using an additional structure, for example made of wood or steel. Replacement, on the other hand, whereby decayed wood is removed, is by nature a non-reversible intervention (Larsen & Marstein, 2016).

Replacement of ceiling joists is particularly difficult and expensive because of the risk of damage to floorboards above and the ceiling below. Repair should, where possible, leave the ceiling joists in place, while reinforcing them with timber or steel. Another option is to insert a new ceiling joist between the damaged ones (Larsen & Marstein, 2016).

The third approach is to re-build the structure replacing damaged parts with new, identical parts – that is, by copying (Larsen & Marstein, 2016).

Where beams or joists are not deep enough for their loading, the result is excessive bending, bouncing floors, and possibly even cracks. One option is to increase the effective depth by fixing additional timber to the top of the component to increase its stiffness. If the depth of a beam only needs to be increased marginally, one very neat solution is to firmly attach the floorboard material to the top of the beam. However, fixing the rest of the floorboards around it can be a head-scratcher (Russell, 2020).

When the ends of beams or joists are decayed, or in cases where either the beam or its support has moved leaving too little bearing, it is essential to increase the junction between the two. Extending the end of the timber can be done with side-planting or splicing-in, but the alternatives are many and varied. The bearing can be extended by introducing steel or timber bolted under the beam; by forming a whole box section steel shoe attached into the beam; by adding a timber, steel or masonry post under the end of the beam, down to the ground; or by creating a timber or steel corbel on the wall beneath



**Fig. 6.33.** Typical solutions where a beam end has decayed (Russell, 2020).

the end of the timber. Similarly, a beam pulling out of an adjacent beam can be picked up with a fabricated strap like a joist hanger (Fig. 6.33) (Russell, 2020).

Doors and windows typically suffer from rot at the base of the frame and door leaf or window sash, and also from loosening of joints. After any necessary patching of pieces which are beyond repair, the joints should be made tight by replacing wedges and reglueing. On window sashes, minor decay combined with loose joints can often be repaired by removing the decay and repairing with epoxy, and using brass angle brackets let into the surface on the inner face (NSW Heritage Office, 2004).

## 6.6. FAILURES OF WOODEN BUILDINGS AND PREVENTIVE ACTIONS

---

**Laura Tupenaite,**

Department of Construction Management and Real Estate,  
Vilnius Gediminas Technical University

**Mindaugas Krutinis,**

Study and Consulting Center

---

A meaning for failure may be deterioration or decay, especially of vigour, strength, etc. It means that there is an expectation about the structure performance, which is not satisfactory (Palaia, 2007).

Building failures can be categorized into the two broad groups of *physical (structural)* failures (which result in the loss of certain characteristics, e.g. strength) and *performance* failures (which means a reduction in function below an established acceptable limit) (Douglas & Ransom, 2007).

Failures also can be defined as events which directly or indirectly have or could have implied risk for human lives. Examples are direct collapses of structures, local cracking, crushing or degradation which can be expected or suspected to have adverse effects on the safety of the structure (Frühwald et al., 2007).

Mechanical failures can affect the structure at any level: members, units, connections, and whole structural system. The most common types of failures are discussed below.

## 6.6.1. Common Types of Failures of the Timber Structural Systems

### 1. Failures of members

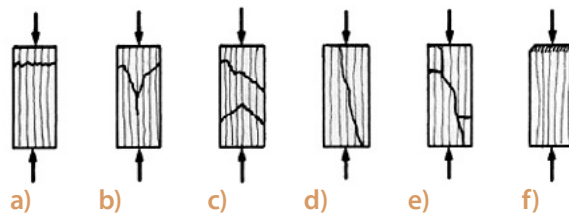
Due to the fibrous nature of the wood tissue, the way of breaking of the members is influenced by the kind of stress (Tampone, 2007). The most common types of stress are compression, tension and bending.

**Compressive stress** is the force that can cause the deformation of the material. High compressive stress leads to failure of the material due to tension.

Some examples of failure types of nonbuckling clear wood in compression parallel to grain are provided in Fig. 6.34.

The longitudinal compression stress mainly occurs in pillars, columns, posts, stakes, in rulers of the lattice girders. The failures are transversal lines which represent the crumpling and buckling of the cells, generally visible to the unaided eye, sometimes to be looked for with optical aids (Tampone, 2007).

The consequences are generally severe on the member and on the whole structural system with regrettable consequences on the construction: the simple deflection of the strut, slender and therefore flexible, is sufficient to reduce the tension and avoid rupture in the member but the rafter experiences a further deformation and at last it breaks (Tampone, 2007).



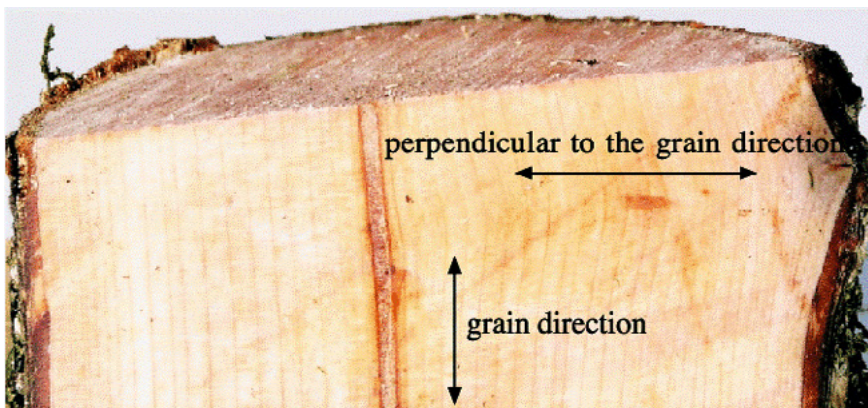
**Fig. 6.34.** Failure types of nonbuckling clear wood in compression parallel to grain: (a) crushing, (b) wedge splitting, (c) shearing, (d) splitting, (e) crushing and splitting, (f) brooming or end rolling (Bodig & Jayne, 1993).

An example can be seen in Fig. 6.35. Break of the rafter of a truss caused by the instability of the strut, with the complicity of a knot of the rafter and the notch for the joint, both exactly at the connection with the strut; this, too thin, is bent with the concavity towards the tie. The bending of the strut has been most probably preceded by the deformation of the rafter (Tampone, 2007).

A problem which is typical for timber structures is the risk for tension failure due to the low strength of wood in the perpendicular to grain direction (Fig. 6.36).



**Fig. 6.35.** Church of Mirteto, Italy (Tampone, 2007).



**Fig. 6.36.** Grain directions on a tree (Aydin et al., 2007).



The value of ultimate tensile stress parallel to the grain is of the order of 45–120 MPa at 12 % moisture content, whereas the tensile stress perpendicular to the grain may only be 2–6 % of the parallel-to-grain value. “Thus, it is difficult to get wood to fail in tension parallel to the grain without having excessive failure in tension perpendicular to the grain” (Encyclopedia of Materials: Science and Technology, 2001).

Because of these low strength values, it is advisable to design timber structures in such a way that tension stresses perpendicular to grain do not occur or are minimized (Woodproducts.fi, 2020).

In practice a break to tensile stress is rare in the ties unless these are damaged by fungal attacks; mostly this kind of failure should be found in the beams (Tampone, 2007).

Predominantly, breaks of the members are caused by bending moments. The strength of the wood is fundamentally affected by the direction in which it is loaded in relation to the grain. In the direction of the grain, the bending strength is directly proportional to the density of the wood. In uniform, flawless wood, the bending strength is as great as the tensile strength (Woodproducts.fi, 2020).

Example of beam failure due to bending is provided in Fig. 6.37.



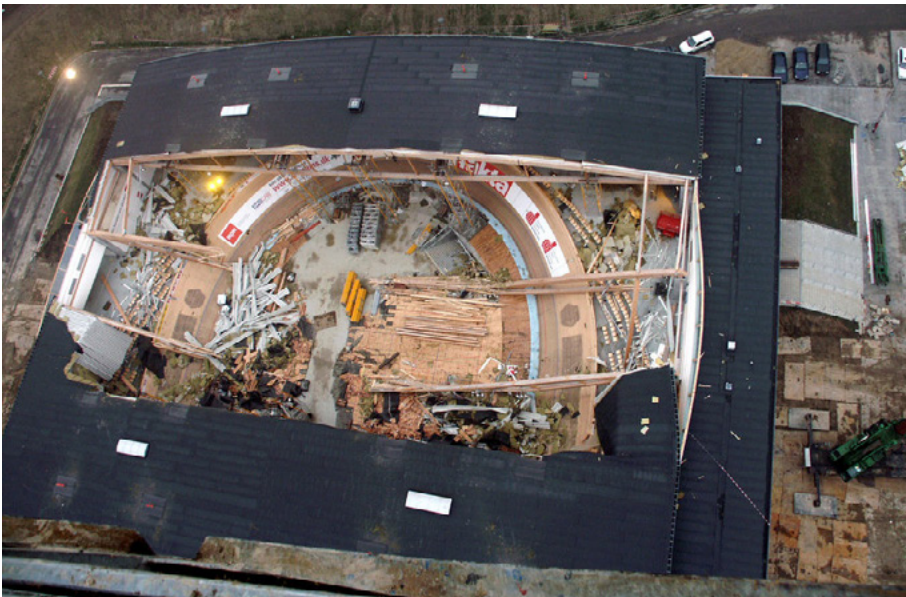
**Fig. 6.37.** Beam cracked by bending. The crack extends from the sides to the bottom edge (Tampone, 2007).

## 2. Failures of connections

---

Amongst the main causes of disconnection of the joints we ought to remember the effects of swelling and shrinkage produced by the fluctuations of temperature and humidity, the ageing of the adhesives, the defects and the biotic damage of the wood, the corrosion of the metallic fastenings, the inadequacies of the design and occasional factors. At the more general level, the effects are reduction of the abutment surfaces and consequent concentration of the stresses on small areas, eccentricity of the stresses, widening of the encasement with occurrence of clearances (Tampone, 2007).

The most common method to connect timber elements today is by mechanical dowel type joints. Among the failure cases where joints are involved this is also the dominating type. The design of joints in timber structures is a difficult problem. The stress transfer in dowel type joints is very complex and cannot be described in detail in normal design situations. An additional complication is that wood is anisotropic and the risk of creating stresses perpendicular to grain is hard to evaluate. Eccentricities may develop in the joint area leading to much higher stresses in the wood than those found from the global analysis



**Fig. 6.38.** Top view on Siemens Arena Ballerup, Denmark, collapse of 2 out of 12 main trusses (Hansson & Larsen, 2005).

of the structure. In the joint region the dowels may also reduce the wood cross section in a significant way (Frühwald et al., 2007).

A well-known example is the spectacular collapse of two long span roof trusses in the Ballerup arena in Denmark in January 2003. It suffered from gross errors in the structural design, reducing the load-carrying capacity of the heel joint of the fish-shaped truss to 25–30 % of its required strength. Due to this, two of the 72 m long trusses collapsed without warning and under very low variable loads shortly after the opening of the arena (see Fig. 6.38).

### 3. Failures of units

---

Structural units fail when the connections lose their efficacy and, obviously, when one or more members lose their integrity (Tampone, 2007).

Geometrical imperfections of the members such as irregularities of the grain or differences in width along the shaft, geometric imperfections of the assembly of the pieces, lack of linearity or not rational position of the loads can have the effect of the unit to twist or, in any case, lose its planarity. For example, trusses of the roofs are supposed to lay in a vertical plane; when they twist or rotate, in general around the chord and on the supports, they lose almost completely their bearing capacity (Tampone, 2007).

Large-span timber structures usually consist of main frames (i.e. columns and girders), secondary elements and bracing elements (Thelandersson & Honfi, 2009). To avoid collapse due to bracing failure, it is recommended to implement moment-resisting joints between columns and horizontal girders (Thelandersson & Honfi, 2009, cit. from Huber et al., 2019).

Bracing can be used temporarily for safety whilst erecting the trusses, for stability on a permanent basis (to keep the trusses in place) or to combat wind where bracing can transmit wind forces to suitable load bearing walls (Minera, n.d.) (Fig. 6.39).

Mistakes are made with respect to temporary bracing during the construction phase, which may lead to instability collapse and accidents at the building site. This type of failure is very typical and can be avoided by planning of the erection sequences to minimise the risks and by giving clear instructions to the construction workers at the site on how to provide temporary bracing. Generally, more careful work preparation is needed at the building site.



**Fig. 6.39.** Bracing of the roof (Minera, n.d.).

For more complex structures, the designer should be responsible for giving instructions about appropriate methods of bracing also in the construction phase (Frühwald et al., 2007).

#### **4. Failures of systems**

---

Break of the components, units and members, disconnections are not a necessary condition for the failure of the system due to favourable factors as elasticity and deformability of the wooden members, ductility of the joints, solidarity, etc. (Tampone, 2007).

Final failure of the structural systems leads to the collapse of the construction. An example of this mode is the failure of Temple of Pagan-gyi in Myanmar (Fig. 6.40), being about to collapse since years, affected by instability and irreversible, severe deformation which is most probably caused by deficiency of stiffness in the posts at the various levels and lack of bracing of the





**Fig. 6.40.** Temple of Pagan-gyi in Myanmar (Tampone, 2007).

construction. They are an extraordinary witness of structural behaviour, and the proof of the enormous resources of endurance the wood owns is very strong (Tampone, 2007).

### 6.6.2. Causes of Failures

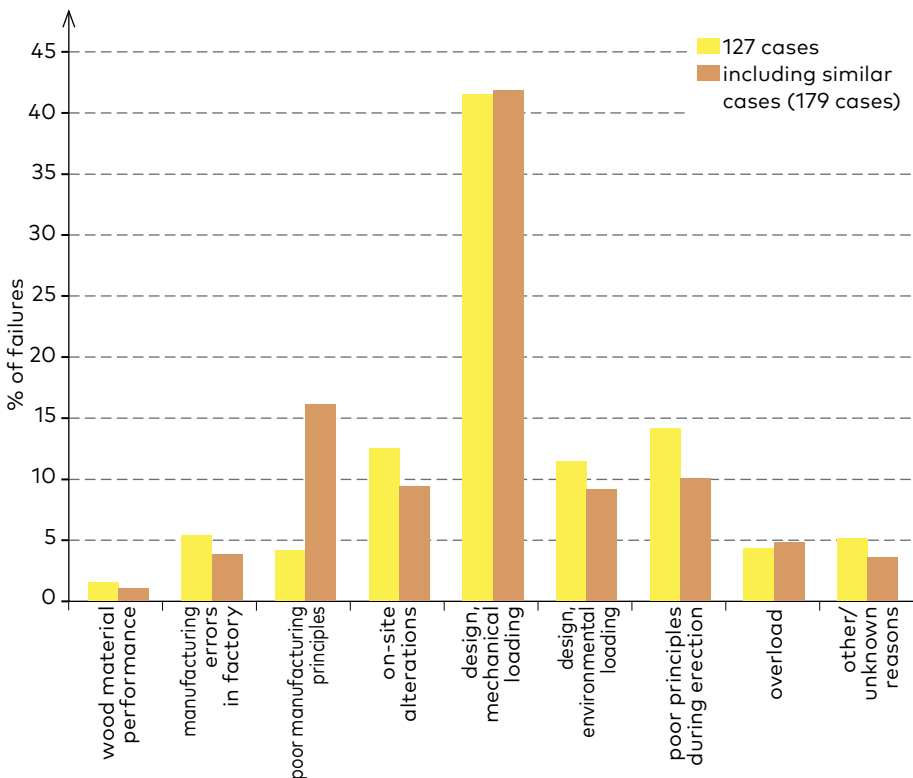
---

The causes of structural failures are numerous. Frühwald et al. (2007) studied and summarized 127 timber structures' failure cases mostly from Scandinavia (Sweden, Finland and Norway) as well as Germany and the United States. For each case in the study, one cause or sometimes several causes of failure were identified. The different types of errors were classified with respect to the following nine categories (Frühwald et al., 2007).

1. Wood material performance: the materials used in the product have been of poor quality in relation to practice. Example: larger knots than permitted in glulam laminations.
2. Manufacturing errors in factory: this relates to manufacturing errors which should have been detected in the production process according to

practice and internal quality control. Example: poor bonding quality of finger joints in glulam.

3. Poor manufacturing principles: this means that the basic principle used for manufacturing the product has been poor. However, the poor principle has been used as intended in the process. Example: use of a wrong glue type.
4. On-site alterations: here, alterations of the structure have been made on site. These alterations have led to the failure. Note that it is often difficult to know whether these alterations were intended from start or made on site for practical reasons.
5. Poor principles during erection: failures which are due to poor handling at the erection of the structure are grouped in this category.
6. Poor design / lack of design with respect to mechanical loading: this means that the failure was due to errors in the strength design of the structure (design method). In this category only mechanical loading is considered.



**Fig. 6.41.** Distribution of error types for the cases in the data base with or without including parallel cases (Frühwald et al., 2007).

7. Poor design / lack of design with respect to environmental actions: this means that the failure was due to errors in strength design, but the failure was caused by mechanical loading in combination with environmental actions. Example: drying cracks, shrinkage effects and durability damage.
8. Overload in relation to building regulations.
9. Other / unknown reasons (e.g. lack of maintenance).

The most common cause of failure found in the investigated cases is poor design or lack of strength design (41 %). Other important failure causes are poor principles during erection (14.1 %), on-site alterations (12.5 %) and insufficient or lacking design with respect to environmental actions (11.4 %). In total, about half of the failures are related to design. About one fourth of the failures are caused at the building site (on-site alterations, poor principles during erection). This means that wood quality, production methods and principles only cause a small part (altogether about 11 %) of the failures. The problem is, therefore, not the wood material but engineers and workers in the building process. This picture is similar to that found from other failure

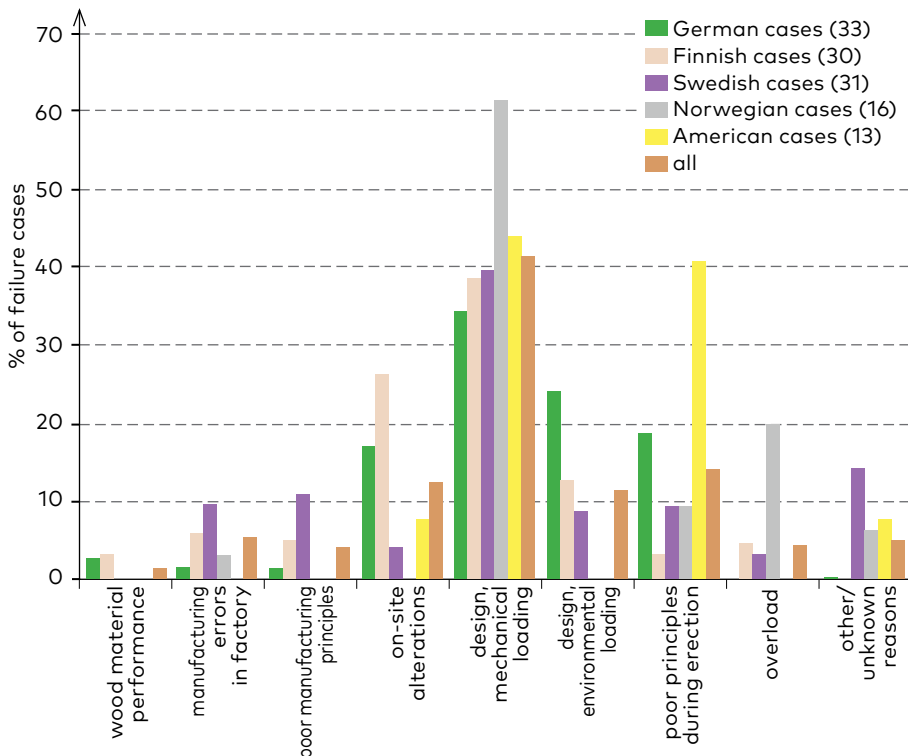


Fig. 6.42. Failure causes depending on country (Frühwald et al., 2007).

investigations for other types of structures (mostly steel and concrete), where human errors were found to be the dominating cause behind failure events. Figure 6.41 shows the distribution of error types in the case studies. It can be seen that the most common cause of failure is related to design and mechanical loading (Frühwald et al., 2007).

The study by Frühwald et al. (2007) also showed that some failure causes are more common in certain countries. For example, overloading (of snow) seems to be particular to Norway, whereas disregard of design for environmental actions is mostly found in the German cases (see Fig. 6.42). Manufacturing errors in factory and poor manufacturing principles are most common in the cases from Sweden. On-site alterations are most common in Finnish cases, and poor principles during erection is frequent in the cases from the United States (Frühwald et al., 2007).

### 6.6.3. Preventive Actions

---

The progression of the failures in a wooden healthy structural system is, generally speaking, rather slow; this is also due to the deformability of the wooden members and the ductility of the joints, two factors that prevent the system from immediate breaks. Therefore, a number of symptoms make their appearance since the very beginning of a critical situation (Tampone, 2007).

One more fundamental factor, solidarity of the healthy members towards the failing ones, is to be taken into special account. In fact, in a structural system well designed, the connections at any level are efficacious and if happens, for instance, that a rafter of a truss breaks, the auxiliary beams, i.e. the other beams which connect the trusses and bear the covering, in a roof the purlins, will act as ties and keep the broken rafter even if this will sink considerably. It is a very dangerous, temporary phase but the delay of collapse is sufficient to allow the quick adoption of suitable measures (Tampone, 2007).

Many examples of this complex, surprising mechanism are to be found in the practice. The experienced technician is able, in general, to detect precocious symptoms of failure in occasion of inspections or normal maintenance to the building because the structures, especially the timber ones, are very communicative and express clearly their disease (Tampone, 2007).



Recent studies, however, have revealed that most failures of timber structures are not caused by local defects but by global defects from systematic mistakes such as global weakening of structural elements due to systematic (repetitive) mistakes (Dietsch & Munch-Andersen, 2010).

It can be stated that there is no strategy for the structural designer which ensures robustness in all cases. When deciding on a robustness strategy, one has to consider different scenarios. The major difference is whether the cause of failure is likely to be a systematic (mostly human) error or an unforeseeable (mostly local) incident. This is subsumed in Table 6.8 which lists types of damaging effects and possible robustness approaches according to Dietsch & Munch-Andersen (2010).

Table 6.8  
Preferable Robustness Approach Depending on the Type  
of Damaging Effect (Dietsch & Munch-Andersen, 2010)

<b>Local effects – local failures, e.g.</b>	<b>Global effects, e.g.</b>
<ul style="list-style-type: none"> <li>● Local deterioration of element from, e.g. local water ingress</li> <li>● Local weakening of element from, e.g. holes</li> <li>● Local overloading from, e.g. local snow accumulation</li> </ul>	<ul style="list-style-type: none"> <li>● Global weakening of structural elements due to systematic mistakes</li> <li>● Global deterioration of elements from, e.g. wrong assumption of ambient climate</li> <li>● Global overloading from, e.g. addition of green roof without structural verification</li> </ul>
<b>Robustness approach</b>	<b>Robustness approach</b>
<ul style="list-style-type: none"> <li>● Redistribution of loads to adjacent (undamaged) elements by, e.g. redundant secondary system</li> </ul>	<ul style="list-style-type: none"> <li>● Limiting failure to local level by, e.g. determinate secondary systems with ‘weak / flexible’ connections</li> <li>● Compartmentalization / segmentation</li> </ul>

It is more or less impossible to eliminate the risk of human errors completely, but their frequency can be reduced by improving building process management, where an important element is to assign or commission personnel with adequate experience and education, as well as with the right attitude to the tasks at hand. This is, however, difficult to achieve in many building projects, since the client which should have the incentive for this often lacks the professional competence. This is a general problem in the building sector (Frühwald et al., 2007).

On a generic level, only the first category of human error, lack of knowledge, can be reduced by improved training and education. The second and the

third types which have to do with human attitudes are more difficult to take measures against. One way is to implement more efficient Quality Assurance (QA) systems in the building process. Such systems may be developed with special focus on design and construction of timber structures (Frühwald et al., 2007).

## REFERENCES

- Abdel, M. (2011, October). *3D laser scanners: history, applications, and future*. Assiut University.
- Agacad (2020). <http://www.aga-cad.com/>
- Al-Ansari, N., Attya, H., & Knutsson, S. (2014). GIS Applications for Building 3D Campus, utilities, and implementation mapping aspects for university planning purposes. *Journal of Civil Engineering and Architecture*, 8(1), 19–28. <https://doi.org/10.17265/1934-7359/2014.01.003>
- Al-Zubaidi, H. (1997). Assessing the demand for building maintenance in a major hospital complex. *Property Management*, 15(3), 173–183. <https://doi.org/10.1108/02637479710178189>
- Andrews, C. (2019). *5 myths and 5 realities of BIM-GIS integration*. <https://www.esri.com/arcgis-blog/products/arcgis-pro/3d-gis/5-myths-5-realities-bim-gis-integration/>
- Ashida, Y., Wakitani, S., & Yamamoto, T. (2017). Design of an implicit self-tuning PID controller based on the generalized output. *IFAC-PapersOnLine*, 50(1), 13946–13951. <https://doi.org/10.1016/j.ifacol.2017.08.2216>
- Autodesk (2020). <https://www.autodesk.eu/>
- Autodesk. (n.d.). *What are the benefits of BIM?*. <https://www.autodesk.com/solutions/bim/benefits-of-bim#>
- Aydin, S., Yardımcı, M. I., & Ramyar, K. (2007). Mechanical properties of four timber species commonly used in Turkey. *Turkish Journal of Engineering and Environmental Sciences*, 31(1), 17–27.
- Bakuya, T. & Matsui, M. (1997). *U.S. Patent No. 5,680,614*. Washington, DC: U.S. Patent and Trademark Office.
- Balas, V. E., Jain, L. C., & Kovačević, B. (2013). Soft computing applications. In *Proceedings of the 5th international workshop soft computing applications (SOFA)* (Vol. 195, pp. 01–04). <https://doi.org/10.1007/978-3-642-33941-7>
- BIMMDA. (2020). *Life cycle of an enterprise*. <https://bimmda.com/en/what-is-bim>
- Bochemit. (2020). *Wood-decaying pests*. <https://www.bochemit.eu/en/about-impregnation/wood-decaying-pests/a-25/>
- Bodig, J. & Jayne, B. A. (1993). Failure modes. In *Mechanics of wood and wood composites*. Krieger Publishing.
- Borodinecs, A., Zemitis, J., Dobelis, M., & Kalinka, M. (2018). 3D scanning data use for modular building renovation based on BIM model. In *MATEC Web of Conferences* (Vol. 251, p. 03004). EDP Sciences. <https://doi.org/10.1051/mateconf/201825103004>
- Bortolini, R., Forcada, N., & Macarulla, M. (2016). *BIM for the integration of Building Maintenance Management: A case study of a university campus*. Barcelona, Spain.

- Bos, S. (2018). *The role of coatings in mass timber performance*. <http://www.wooddesignandbuilding.com/role-coatings-mass-timber-performance/>
- Broda, M. (2020). Natural compounds for wood protection against fungi—A review. *Molecules*, 25(15), 3538. <https://doi.org/10.3390/molecules25153538>
- Chanter, B. & Swallow, P. (2008). *Building maintenance management*. John Wiley & Sons. <https://doi.org/10.1002/9780470692011>
- Cheves, M. (2014). *Monumental challenge*. [http://hds.leicageosystems.com/hds/en/TheAmericanSurveyor\\_Cheves-MonumentalChallenge\\_NovDec2014\\_opt.pdf](http://hds.leicageosystems.com/hds/en/TheAmericanSurveyor_Cheves-MonumentalChallenge_NovDec2014_opt.pdf)
- Chew, M. Y. L., Tan, S. S., & Kang, K. H. (2004). Building maintainability—Review of state of the art. *Journal of Architectural Engineering*, 10(3), 80–87. [https://doi.org/10.1061/\(ASCE\)1076-0431\(2004\)10:3\(80\)](https://doi.org/10.1061/(ASCE)1076-0431(2004)10:3(80))
- City of Melbourne. (2020). <https://www.melbourne.vic.gov.au>
- DC Scientific Pest Control. (n.d.). *5 signs you may have termites*. <https://dcspestcontrol.com/2020/02/5-signs-you-may-have-termites/>
- Department for Environment Food & Rural Affairs. (2020). *CS building maintenance plan and log*. [https://assets.publishing.service.gov.uk/government/uploads/system/uploads/attachment\\_data/file/920459/Building\\_Maintenance\\_Plan\\_and\\_Log\\_cs31\\_V3.0\\_Sep\\_20\\_.pdf](https://assets.publishing.service.gov.uk/government/uploads/system/uploads/attachment_data/file/920459/Building_Maintenance_Plan_and_Log_cs31_V3.0_Sep_20_.pdf)
- Dietsch, P. & Munch-Andersen, J. (2010). Robustness in large-span timber structures – structural aspects and lessons learned. In J. D. Sørensen, P. Dietsch, P. H. Kirkegaard, & J. Köhler. *Guideline - Design for Robustness of Timber Structures*. COST Action E55 “Modelling of the Performance of Timber Structures” (pp. 36–48).
- Donnelly, J. (2007). *Maintenance: a guide to the care of older buildings*.
- Douglas, J. & Ransom, W. H. (2007). *Understanding building failures* (3rd ed.). New York: Routledge. <https://doi.org/10.4324/9780203030141>
- Finch, E. & Zhang, X. (2013). Facilities management. In *Design and Management of Sustainable Built Environments* (pp. 305–326). Springer, London. [https://doi.org/10.1007/978-1-4471-4781-7\\_15](https://doi.org/10.1007/978-1-4471-4781-7_15)
- Frühwald, E., Serrano, E., Toratti, T., Emilsson, A., & Thelandersson, S. (2007). *Design of safe timber structures – How can we learn from structural failures in concrete, steel and timber?* Division of Structural Engineering, Lund University.
- Gao, X. & Pishdad-Bozorgi, P. (2019). BIM-enabled facilities operation and maintenance: A review. *Advanced Engineering Informatics*, 39, 227–247. <https://doi.org/10.1016/j.aei.2019.01.005>
- Geosense. (2020). *Sensors and applications for construction monitoring*. <https://www.geosense.co.uk>
- González-Laredo, R. F., Rosales-Castro, M., Rocha-Guzmán, N. E., Gallegos-Infante, J. A., Moreno-Jiménez, M. R. & Karchesy, J. J. (2015). Wood preservation using natural products. *Madera y Bosques*, 21, 63–76. <https://doi.org/10.21829/myb.2015.210427>
- GPS Partners. (2020). *LEICA*. <https://www.gpspartners.lv/>
- Hanke, K. & Grussenmeyer, P. (2002). Architectural photogrammetry: Basic theory, procedures, tools. In *ISPRS Commission* (Vol. 5, pp. 1–2).

- Hansson, M. & Larsen, H.-J. (2005). Recent failures in glulam structures and their causes. *Engineering Failure Analysis*, 12(5), 808–881.  
<https://doi.org/10.1016/j.engfailanal.2004.12.020>
- Heritage Buildings Unit. (2008). *Heritage building maintenance manual*. Canada.  
[https://www.gov.mb.ca/chc/hrb/pdf/maintenace\\_for\\_heritage\\_bldgs.pdf](https://www.gov.mb.ca/chc/hrb/pdf/maintenace_for_heritage_bldgs.pdf)
- Homeowner Protection Office (n.d.). Exposed wood structures. Maintenance matters. *Building Envelope Maintenance Bulletin*, No. 9.
- Jelgava old city. (2020). <http://realitymodels.northeurope.cloudapp.azure.com/rm/>
- Jelgavas Vecpilsētas ēku pārbūve, restaurācija. (2020). <http://www.reregrupa.lv/lv/projekti/jelgavas-vecpilsetas-eku-parbuve-restauracija/>
- JICA Project Team. (2020). *Manual guiding building facility maintenance procedures*.  
[https://openjicareport.jica.go.jp/pdf/12151171\\_02.pdf](https://openjicareport.jica.go.jp/pdf/12151171_02.pdf)
- Joseph, J. (2018). Facility design and process utilities. In *Biopharmaceutical processing* (pp. 933–986). Elsevier. <https://doi.org/10.1016/B978-0-08-100623-8.00045-1>
- Koka ēku renovācijas centrs “Koka Rīga”. (2017). <https://www.rigasaustrumi.lv/>
- Kolaitis, D. I., Asimakopoulou, E. K., & Founti, M. A. (2014). Fire protection of light and massive timber elements using gypsum plasterboards and wood-based panels: A large-scale compartment fire test. *Construction and Building Materials*, 73, 163–170.  
<https://doi.org/10.1016/j.conbuildmat.2014.09.027>
- Larsen, K. E. & Marstein, N. (2016). *Conservation of historic timber structures. An ecological approach*. Oslo.
- Learn Computer Science. (2020). *Database management system*.  
<https://www.learncomputerscienceonline.com/database-management-system/>
- Lee, H. H. Y. & Scott, D. (2009). Overview of maintenance strategy, acceptable maintenance standard and resources from a building maintenance operation perspective. *Journal of Building Appraisal*, 4(4), 269–278.  
<https://doi.org/10.1057/jba.2008.46>
- LEICA Geosystems (2020). <https://www.leica-geosystems.com/>
- Minera. (n.d.). *The importance of roof truss bracing*.  
<https://www.minera-rooftrusses.com/news/15/roof-bracing>
- Motawa, I. & Almarshad, A. (2013). A knowledge-based BIM system for building maintenance. *Automation in Construction*, 29, 173–182.  
<https://doi.org/10.1016/j.autcon.2012.09.008>
- Mwaniki, M. W. & Odera, P. A. *Application of GIS in facility space management: A case study of ILRI*.
- National Geographic. (2017). *GIS (Geographic Information System)*.  
<https://www.nationalgeographic.org/encyclopedia/geographic-information-system-gis/>
- Novák, E., Vpelák, J., Clavel, M. (2016). *Advanced controls / Performance monitoring and control of integrated systems*. <https://www.more-connect.eu/wp-content/uploads/2018/04/Advanced-controls-Performance-Monitoring-and-Control-of-Integrated-Systems.pdf>

- NSW Heritage Office. (2004). *Timber repairs*. <https://www.environment.nsw.gov.au/resources/heritagebranch/heritage/maintenance52timber.pdf>
- Palaia, L. (2007). Structural failure analysis of timber floors and roofs in ancient buildings at Valencia (Spain). In *Material to Structure – Mechanical Behaviour and Failures of the Timber Structures ICOMOS IWC – XVI International Symposium*. Florence, Venice and Vicenza, Italy.
- Perera, D. W. U., Pfeiffer, C. F., & Skeie, N. O. (2014). Control of temperature and energy consumption in buildings - A review. *International Journal of Energy & Environment*, 5(4).
- Pix4D manuals. (2020). <https://support.pix4d.com/hc/en-us/sections/360003718992-Manual>
- RICS. (1990). *Planned building maintenance: A guidance note*. London: Royal Institution of Chartered Surveyors.
- Rovers, R., Zikmund, A., Lupisek, A., Borodinecs, A., Novák, E., Matoušková, E., & Almeida, M. G. D. (2018). *A guide into renovation package concepts for mass retrofit of different types of buildings with prefabricated elements for (n) ZEB performance*. RTU, 2018.
- Russel, R. (2020). *Structural timber repairs*. <https://www.buildingconservation.com/articles/structural-timber-repairs/structural-timber-repairs.htm>
- Sandak, A., Sandak, J., & Riggio, M. (2015). Assessment of wood structural members degradation by means of infrared spectroscopy: an overview. *Structural Control Health Monitoring*, 23(3), 396–408. <https://doi.org/10.1002/stc.1777>
- Shen, Q. (1997). A comparative study of priority setting methods for planned maintenance of public buildings. *Facilities*, 15(12/13), 331–339. <https://doi.org/10.1108/02632779710188324>
- Sisense. (2020). *What is a relational database management system?*. <https://www.sisense.com/glossary/relational-database/>
- Tampone, G. (2007). Mechanical failures of the timber structural systems. In *Material to Structure - Mechanical Behaviour and Failures of the Timber Structures ICOMOS IWC – XVI International Symposium*. Florence, Venice and Vicenza, Italy.
- Tehnoloģiju pieskāriens vēsturei. (2020). <https://buvinzenierusavieniba.lv/tehnologiju-pieskariens-vesturei/>
- Thelandersson, S. & Honfi, D. (2009). Behaviour and modelling of timber structures with reference to robustness. In J. Köhler, H. Narasimhan, & M. H. Faber (Eds.), *Proceedings of the Joint Workshop of COST Actions TU0601 and E55* (pp. 125–138), Ljubljana (Brussels: COST Office).
- Tikkurila (2020). <https://www.tikkurila.com/>
- Victor, J. (2020). *GIS and BIM integration in infrastructure design and construction*. <https://www.gislounge.com/gis-and-bim-integration-in-infrastructure-design-and-construction/>

- Wang, S. & Xie, J. (2002). Integrating building management system and facilities management on the internet. *Automation in Construction*, 11(6), 707–715. [https://doi.org/10.1016/S0926-5805\(02\)00011-0](https://doi.org/10.1016/S0926-5805(02)00011-0)
- Western Wood Structures. (2020). *Structural timber repairs*. <https://www.westernwoodstructures.com/index.php/services/structural-timber-repair>
- Wood Solutions (n.d.). *Timber maintenance*. <https://www.woodsolutions.com.au/articles/timber-maintenance>
- Wood: strength and stiffness. (2001). In *Encyclopedia of materials: science and technology*. Elsevier Science Ltd.
- Woodproducts.fi. (2020). *Strength properties of wood*. <https://www.woodproducts.fi/content/wood-a-material-1>
- Yam, R. C. M., Tse, P. W., Li, L., & Tu, P. (2001). Intelligent predictive decision support system for condition-based maintenance. *The International Journal of Advanced Manufacturing Technology*, 17(5), 383–391. <https://doi.org/10.1007/s001700170173>
- Zabel, R. A. & Morrell, J. J. (2012). *Wood microbiology: Decay and its prevention*. Cambridge, MA, USA: Academic Press.
- Zhang, X., Arayici, Y., Wu, S., Abbott, C., & Aouad, G. F. (2009). *Integrating BIM and GIS for large-scale facilities asset management: a critical review*.



# Chapter 7

## Examples

### 7.1. Examples in Latvia

*Kristine Fedotova, Ineta Geipele, Janis Zvirgzdins*

### 7.2. Example in Lithuania

*Tomas Gecys*

### 7.3. Example in the UK

*Carl Mills, David Trujillo*

### 7.4. Examples in Denmark

*Roger Howard Taylor, Ole Thorkilsen, Peter Ebbesen*

### 7.5. Example in Finland

*Jari Komsu, Anssi Knuutila, Koivula Ilona Mercedes*

### 7.6. International Examples

*Carl Mills, David Trujillo, Tomas Gecys*





## 7.1. EXAMPLES IN LATVIA

---

### 7.1.1. CASE STUDY 1: Open-air stage in Krimuna

---

#### General information

Location: Krimunas, Krimuna parish, Dobele district.

Architects: “RBD” Ltd.

Client: Dobele district municipality.

Year of construction: 2017.

Duration of construction: 2 months.

Height: 7 metres.

Number of floors: One.

Cost: EUR 97469.05 plus VAT 21 %.



**Fig. 7.1.** External appearance after construction (Gada labākā būve Latvijā 2017, 2018. The best building of the year in Latvia, 2018).

## Design and structural principles

The aim of the project is to construct the roof structure on the foundations of the existing stage, making high-quality cultural services available to the residents of Krimuna parish of Dobele district.

The construction of the stage ensures a well-maintained and quality environment for cultural events, promotes a variety of public life activities and makes recreational services available. The stage is designed to partially preserve the platform of the previously built stage. The arched form and wooden architecture are adapted to the environment and artistic events (Figs. 7.1 and 7.2).

## Materials and finishes

The load bearing structures of the stage are made using curved glue-laminated wood beams manufactured in Latvia.

The arches are made using variable geometry to obtain the architectural features of the structure. The load bearing structure consists of curved glue-laminated wood arches with a span of 13.72 m and a total building height of 7.20 m. (Figs. 7.3 and 7.4).



**Fig. 7.2.** Before construction (Gada labākā būve Latvijā 2017, 2018. The best building of the year in Latvia, 2018).

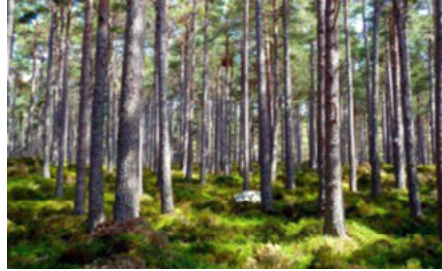


**Fig. 7.3.** Curved glue-laminated wood arches (Gada labākā būve Latvijā 2017, 2018. The best building of the year in Latvia, 2018).



**Fig. 7.4.** Construction phase (Gada labākā būve Latvijā 2017, 2018; The best building of the year in Latvia, 2018).

The load bearing structures are made of 21.62 m<sup>3</sup> of glue-laminated timber. In Latvian forests, 0.95 m<sup>3</sup> grows in 1 second (Latvian State Forests, 2018). The amount of wood used in load bearing structures grows in 22.76 seconds in Latvian forests (Fig. 7.5).



**Fig. 7.5.** Latvian Forests (Latvian State Forests, 2018).

### **Resources consumption in the use stage (water, energy, etc.)**

Within the framework of the project, the construction of the roof structure ensures the possibility of placing the sound and lighting equipment under the roof covering, thus protecting the equipment available to the community centre from rain and other unfavourable factors.

In addition, rainwater drainage system has been built in the construction of the roof, promoting rainwater drainage from the foundations of the stage, which will ensure the sustainability of the stage.

### **Additional information**

The object serves not only as a venue for local cultural events but also as tourist attraction.

## 7.1.2. CASE STUDY 2: Rebuilding the barn of Aluksne station

---

### General information

Location: 52 Jankalna Street , Aluksne, Aluksne district.

Architects: “Arhitektes Ināras Caunītes birojs” Ltd.

Client: Aluksne district Municipality.

Year of construction: 2018.

Duration of construction: 2 years.

Number of floors: One.

### Design and structural principles

National cultural monument preserves rich history and is unique on the Baltic and European scale (Figs. 7.6, 7.7, 7.8 and 7.9).

The goal is to preserve the luggage barn built in 1902 for future generations, to ensure accessibility and to diversify tourism offerings.

### Structural solutions

Soil characteristics: *Simple.*

Foundation: *Shallow (ribbon and pile foundation).*

Object constructive scheme: *Frame.*

Inter-floor covering type: *Wood beam.*



**Fig. 7.6.** External appearance (Gada labākā būve Latvijā 2018, 2019. The best building of the year in Latvia, 2019).



**Fig. 7.7.** Internal view (Gada labākā būve Latvijā 2018, 2019. The best building of the year in Latvia, 2019).

Type of roof covering: *Rafter, bundle and brace structure.*

Non-load bearing exterior wall material: *Wooden stands, planking.*

Partitions: *Wood frame, planking.*

Stair construction: *Wooden staircase on concrete foundation.*

Bearing external wall material: *Wood frame, planking.*

The main challenges in the design process: by making the most of the existing structure to construct an insulated building that would still create an impression of the luggage barn inside and outside.

To restore the foundations, the structure of the building was made as light as possible: the roof covering and planking were removed (Fig. 7.10).

The building frame was lifted and based outside the foundation area.

Boulder foundations were built, the crown beam and the damaged wood structures were replaced.

### Materials and finishes

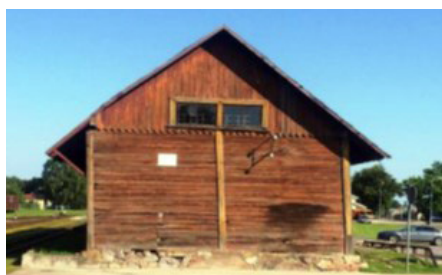
Non-load bearing exterior wall material: *Wooden stands, planking.*

Partitions: *Wood frame, planking.*

Stair construction: *Wooden staircase on concrete foundation.*

Bearing external wall material: *Wood frame, planking.*

The paths surrounding the building are covered with ELASTOPAVE cover – it is visually closest to the historical gravel road surface. ELASTOPAVE cover is natural stone (granite) chips interconnected (bonded) with polyurethane binder. It withstands temperature fluctuations, maintains physical properties, and withstands frost/thaw actions.



**Fig. 7.8.** Before rebuilding (outside)  
(Gada labākā būve Latvijā 2018,  
2019. The best building of the year in  
Latvia, 2019).



**Fig. 7.9.** Before rebuilding (inside)  
(Gada labākā būve Latvijā 2018,  
2019. The best building of the year in  
Latvia, 2019).

Thanks to the porous structure, water does not accumulate in the pavement, and at the same time there is free space where water can expand when changing the physical state. In winter such cover is not slippery.

### **Resources consumption in the use stage (water, energy, etc.)**

Use of energy-efficient solutions:

- Double-skin walls and roof structures filled with eco-wool ensure the thermal stability of the building – heating costs account for EUR 90 per month.
- The heating system of the building is connected to the district heating networks.
- The heating unit is located above the cashier's desk covering and hidden behind the exposition.
- To achieve the impression of unheated space, the heating elements are integrated into the floor.

### **Additional information**

Conservation of cultural heritage and ensuring its accessibility.

A multimedia exposition has been created that allows visitors to get acquainted with the creation and history of narrow-gauge railway.

Renewed infrastructure is an important resource for popularizing the industrial heritage of Latvia and promoting tourism development.

High quality cultural environment has been created.



**Fig. 7.10.** Wooden stands and planking before rebuilding (Gada labākā būve Latvijā 2018, 2019. The best building of the year in Latvia, 2019).



### 7.1.3. CASE STUDY 3: Construction of covered roof of the open public skating rink on Pasta island in Jelgava

---

#### General information

Location: 1 Pasta sala, Jelgava.

Architects: "Igate Būve" Ltd.

Client: Jelgava Municipality.

Year of construction: 2018;

Duration of construction: One year.

Number of floors: One;

Cost: EUR 305,482.02 plus VAT 21 %.



**Fig. 7.11.** Outside view (construction phase) (Gada labākā būve Latvijā 2018, 2019. The best building of the year in Latvia, 2019).

### Design and structural principles

The task of designing the construction project is to protect the existing hockey area from rain and snow (Figs. 7.11–7.14).

The greatest challenge is to design the existing communication in “the jungle”.

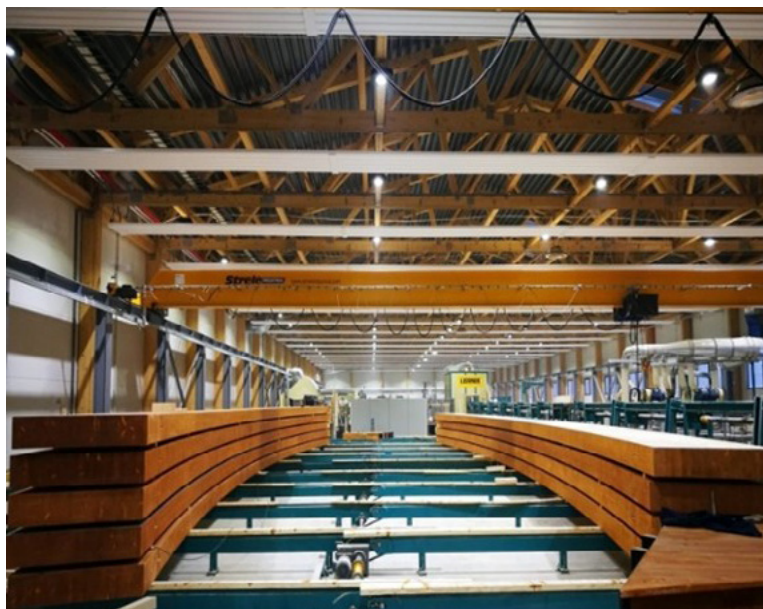


**Fig. 7.12.** External appearance (final view) (Gada labākā būve Latvijā 2018, 2019. The best building of the year in Latvia, 2019).



**Fig. 7.13.** Internal view (final view) (Gada labākā būve Latvijā 2018, 2019. The best building of the year in Latvia, 2019).





**Fig. 7.14.** Wood structure materials (Gada labākā būve Latvijā 2018, 2019. The best building of the year in Latvia, 2019).

The most important challenges in the construction project are related to the moment node and the design of suitable foundation.

### **Materials and finishes**

The roof of the skating rink is made of glue-laminated wood frames covered with a membrane-type roofing. Between the columns, mesh structures are secured to prevent rain and wind (Fig. 7.15).

The structure consists of a three-threaded frame of curved and variable cross-section elements with a common span of 22.60 m.

In addition, different size steel pipe-profile beams have been designed for membrane type roofing reinforcement and additional support.

The roof bearing structures are made of 112 m<sup>3</sup> of glue-laminated timber. In Latvian forests, 0.95 m<sup>3</sup> grow in 1 second (Latvian State Forests, 2018).

The amount of wood used in load bearing structures grows in 2 minutes in Latvian forests.

**Additional information**

The surrounding area is one of the most popular footpaths of residents of Jelgava as well as the central venue for organising events in Jelgava.



**Fig. 7.15.** Three-threaded frame (Gada labākā būve Latvijā 2018, 2019. The best building of the year in Latvia, 2019).

## 7.2. EXAMPLE IN LITHUANIA

---

### CASE STUDY: Universal sports complex in Palanga, Lithuania

---

#### General information

Location: 3 Sports Street, Palanga, Lithuania (Figs. 7.16–7.18).

Architects: Matas Jurevičius, Gediminas Jurevičius.

Client: Palanga city Municipality.

Year of construction: 2014.

Duration of construction: Two years.

Height: 11.3 m.

Number of floors: Two.

Cost: EUR 4.4 million.



**Fig. 7.16.** The outside view of the completed building ([www.sporthall.palanga.lt](http://www.sporthall.palanga.lt)).

### Design and structural principles

The load bearing structure of the multifunctional sports hall is reinforced concrete columns and curved axis glulam beams and arches. The main cross section of the building is shown in Fig. 7.19 in which all load bearing structures are shown. The rectangular shaped reinforced concrete columns are rigidly connected to the foundation; while curved axis glued laminated timber beams are flexibly supported on the reinforced concrete columns and foundation.



Fig. 7.17. Internal view of the completed building ([www.sporthall.palanga.lt](http://www.sporthall.palanga.lt)).

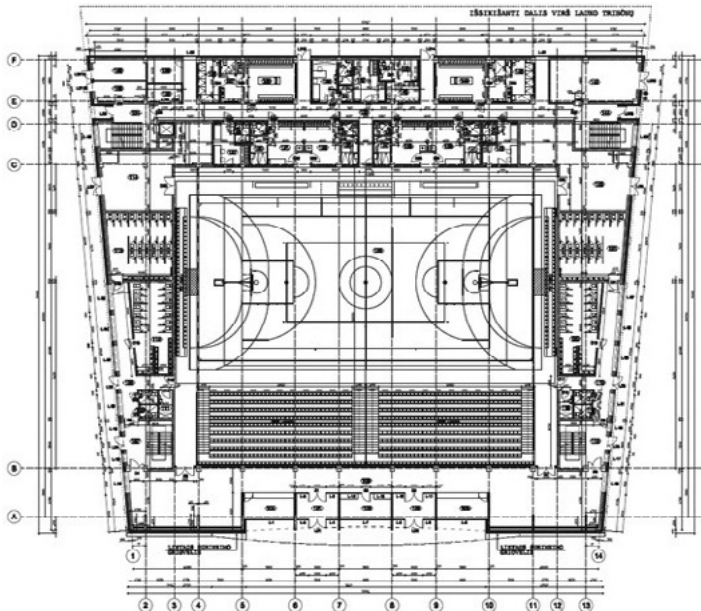


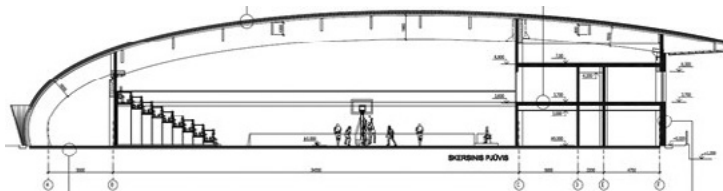
Fig. 7.18. The plan of multifunctional sports hall.

The maximum span (the maximum distance between supports) is 34.55 m. This span is overlaid using the entire glued laminated timber beam. The transportation of the glued laminated timber beams (36 metres long, 180 mm wide; 1960 mm high) to the construction site is shown in Fig. 7.20.

One 36 m long glued laminated timber beam weighs around 10 tones. The mass is relatively small, as timber has a very good strength / mass ratio, especially if compared to heavy material such as reinforced concrete. Views from the construction process are shown in Fig. 7.21 in which main structural materials are shown -, glued laminated timber and reinforced concrete in combination with masonry walls.

### Materials and finishes

As the previous figures show, the timber in the interior has its natural appearance, it is covered only with translucent lacquer. Other structural materials (reinforced concrete and masonry walls) are plastered or covered with plasterboards. Some parts of glulam beams are extracted to the outside of the building, so these parts were covered with thin-walled steel canopies, for protection from rain, snow and sun.



**Fig. 7.19.** The cross section of the multifunctional sports hall in Palanga city, Lithuania.



**Fig. 7.20.** Transportation of 36 m long glulam beams for the multifunctional sports hall in Palanga city, Lithuania ([www.veidas.lt](http://www.veidas.lt)).



**Additional information**

The multifunctional arena is used for both commercial and non-commercial purposes. Some TV shows are filmed in this arena. Also, Lithuanian national basketball team usually trains in this arena for the championships.



**Fig. 7.21.** The construction process of sports hall in Palanga city, Lithuania ([www.sporthall.palanga.lt](http://www.sporthall.palanga.lt)).

## 7.3. EXAMPLE IN THE UK

---

### CASE STUDY: Rievaulx Abbey Visitor Centre

---

#### General information (Figs. 7.22–7.24)

Location: Helmsley, U.K.

Architects: Simpson & Brown.

Client: English Heritage.

Year of construction: Completion date July 2016.

Number of floors: One.

Cost: Contract value: £ 1.2 m.

#### Design and structural principles

Simpson and Brown Architects were appointed by English Heritage for an improved visitor centre at Rievaulx Abbey. The initial aim of the project was to upgrade the existing visitor facilities, upgrade the museum building, improve staffing facilities and attract more visitors to the Abbey (Figs. 7.25–7.27).

The most significant section of the project for this case study is the new central hall within the existing L-shaped building that previously existed.



**Fig. 7.22.** External appearance ([www.ribaj.com](http://www.ribaj.com)).



**Fig. 7.23.** Internal view ([www.architecture.com](http://www.architecture.com)).

This new central hall contains a series of engineered glulam timber arches of Scandinavian spruce painted in stunning white gradually splay to reveal site lines to the abbey and presents itself as a modern mirroring and connection of the historic stone columns and arches beyond. These spruce glulam columns and rafters are joined with epoxy bonded-in rods, and steel flitch plates conceal the join.

Site plan of car park, visitor centre and abbey



Key

- 1 car park and entrance
- 2 visitor centre
- 3 views to abbey
- 4 Rievaulx Abbey
- 5 museum
- 6 original building containing plant, WCs and kitchen
- 7 servery
- 8 glazed glulam arch enclosure with display
- 9 line of glulam arches with inset information panels
- 10 café seating area
- 11 line of splayed glulam arches with glazing between
- 12 glazed screen giving access to terrace
- 13 original building containing shop
- 14 main entrance with timber canopy and screen

Ground floor plan of visitor centre

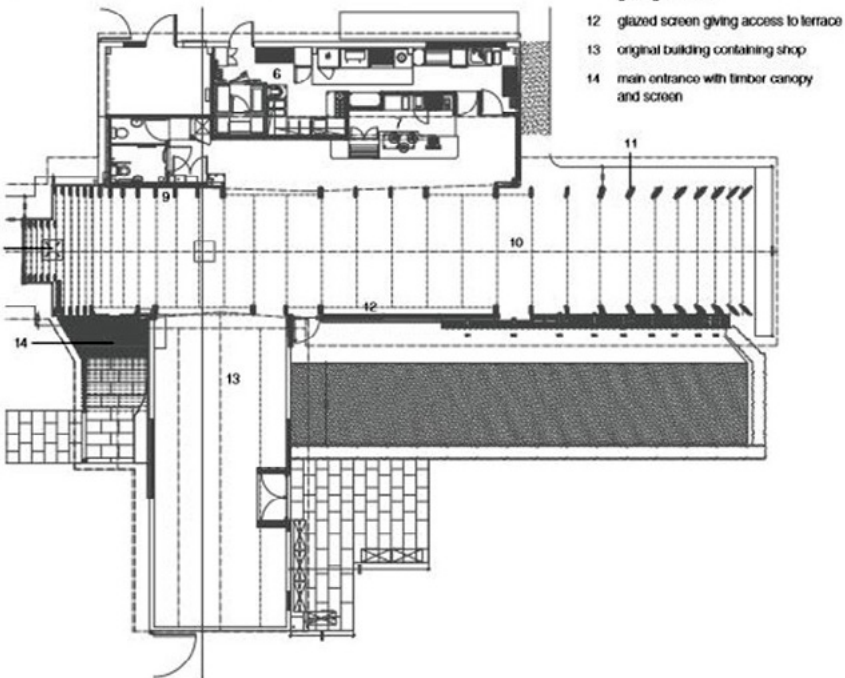


Fig. 7.24. Site and ground floor plan (TRADA, 2019).



Although only single storey, this double height space provides a sense of height that is flooded by natural light, creating a stunningly beautiful space fitting for a site of historical purpose.

Structurally the engineered glulam frames are joined at roof level with CLT sheeting. Concealed services (including lighting) are within a perimeter edge beam, and the panels are visible where feasibly possible.

### Materials and finishes

The main materials used for the project include engineered timber, zinc and polished concrete. A ruin from the abbey is also used, it is exquisitely carved and bears the abbey's name.

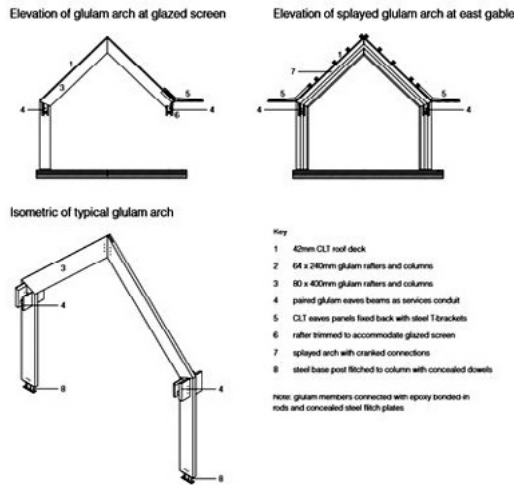


Fig. 7.25. Structural and detail representation (TRADA, 2019).



Fig. 7.26. The central hall ([www.e-architect.co.uk](http://www.e-architect.co.uk)).



Fig. 7.27. 6 Carved stone from the ruin ([www.e-architect.co.uk](http://www.e-architect.co.uk)).

Due to the restricted site and tight construction programme off-site fabrication was used. Slot windows were set inside the vertical CLT panels. Both gable ends of the centre are fully glazed, providing the visitor to key views towards the museum and more importantly the ruin itself (as show in Fig. 32).

The arches (varying in size but consistent heights and pitch) are connected with 42 mm CLT panels at roof level, these protrude the exterior glazing on the gable ends and are fixed with profiled steel T-brackets. These are stained to match the appearance of the arches. The roof is finished in zinc sheet with insulation below.

### **Resources consumption in the use stage (water, energy, etc.)**

The building has a gross internal area of 469 m<sup>2</sup> and uses as much of the original fabric and timber structure as possible. By using prefabricated components, the construction speed was increased, material waste and the need for materials to be transported to site was reduced. This included the two-stage glulam structure.

The design includes a substantial overhang aiding to direct sunlight overheating in summer and entirely naturally ventilated to all key zones. The latest energy saving devices are used in lighting (LED) and controls.

Simple thoughtful design delivers simple maintenance whilst delivering excellent life cycle costs.

### **Additional information**

- Awards Wood Awards Commercial & Leisure Winner 2017.
- RIBA Yorkshire Award, Winner 2017.

## 7.4. EXAMPLES IN DENMARK

---

### 7.4.1. CASE STUDY 1: Wadden Sea Centre

---

#### General information (Figs. 7.28–7.33)

Location: Okholmvej 5, Vester Vedsted, 6760 Ribe, Denmark.

Architects: Dorte Mandrup A/S.

Client: City of Esbjerg.

Year of construction: 2017.

Duration of construction: September 2015 – February 2017.

Number of floors: Two floors, in total 2500 m<sup>2</sup>.

Cost: EUR 6,000,000.



Fig. 7.28. External appearance (Photo: Adam Mørk).



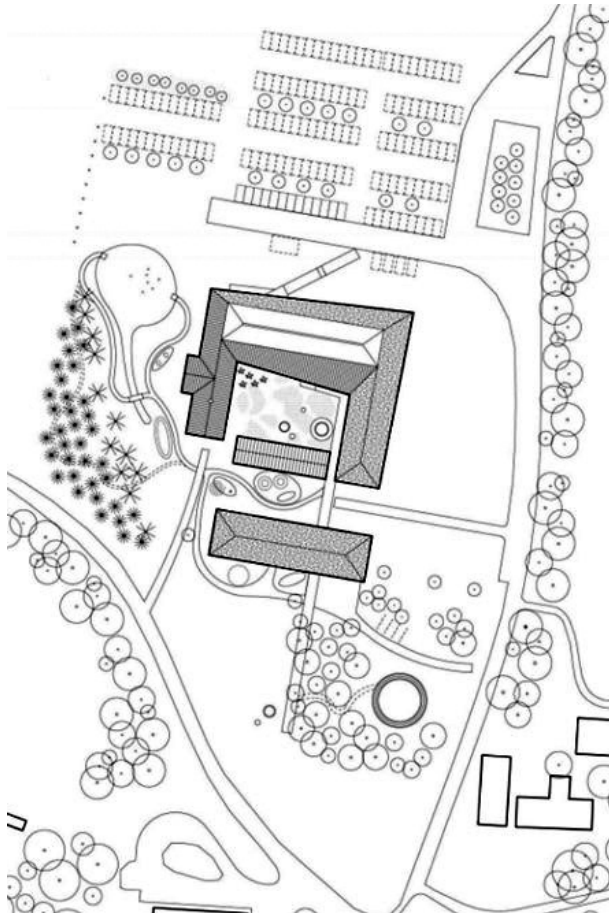
Fig. 7.29. External appearance (Photo: Adam Mørk).



**Fig. 7.30.** Internal view (Photo: Adam Mørk).



**Fig. 7.31.** Internal view (Photo: Adam Mørk).



**Fig. 7.32.** Site plan (Illustration: Dorte Mandrup).

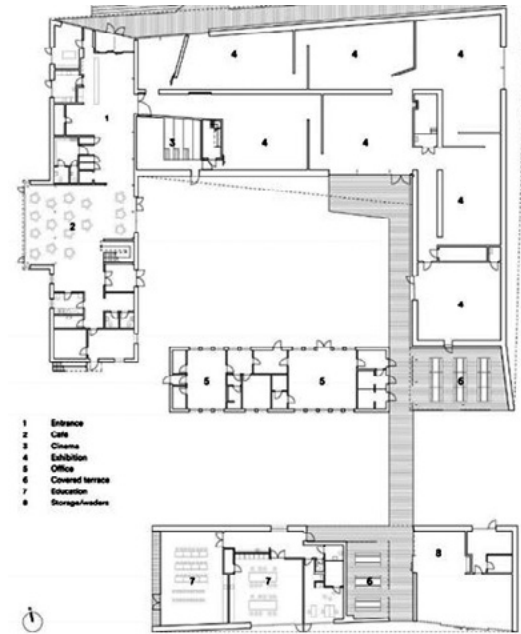


Fig. 7.33. Site plan (Illustration: Dorte Mandrup).

### Design and structural principles

The building, which was initiated in February 2017, is an interpretation of the local building tradition and the rural farmhouse typology significant in the area.

The centre is erected with pre-paginated robin wood and thatched roofs and facades, hereby underlining the tactile qualities and robustness that can be found in traditional crafts and materials of the region.

The combination gives a unique experience and the impression of a building that blends into nature (Figs. 7.34–7.35).

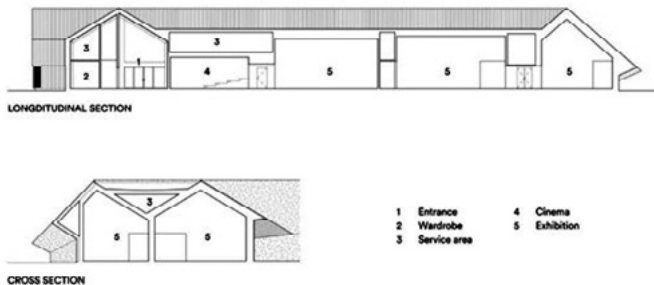


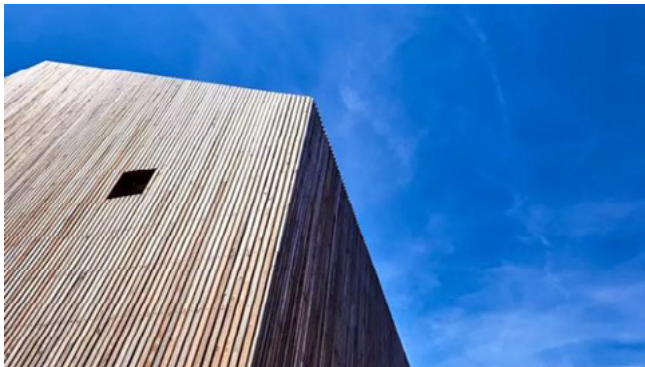
Fig. 7.34. Site plan (Illustration: Dorte Mandrup).



**Fig. 7.35.** External appearance (Photo: Adam Mørk).

### **Materials and finishes**

A combination of pre-patinated robin wood and straw used for the exterior facades and roofs makes this building blend well into the surrounding nature of the area that has been used. Great craftsmanship has been carried out in connection with the construction of the building, which makes the building itself a great experience (Fig. 7.36).



**Fig. 7.36.** External appearance (Photo: Adam Mørk).



**Resources consumption in the use stage (water, energy, etc.)**

- The building is heated with geothermal heat, which has 3.4 km of pipes buried in the outside terrain for the actual geothermal heat.
- There are solar cells hidden on the roof that give 40 % of the annual energy.
- The building is illuminated with led light.
- The building is equipped with water-saving toilets, showers and taps.
- The building is insulated in accordance with the Danish legislation.

## 7.4.2. CASE STUDY 2: "Næste Skur"

---

### General information (Figs. 7.37–7.38)

Location: Holbergskolen KBH N.

Architects: Krydsrum A/S.

Client: Københavns Komune.

Year of construction: 2019.

Duration of construction: 2018–2019.

Height: 3.2 m.

Number of floors: One.

Cost: EUR 46,900.



**Fig. 7.37.** External appearance (Photo: Jonathan Weimar).



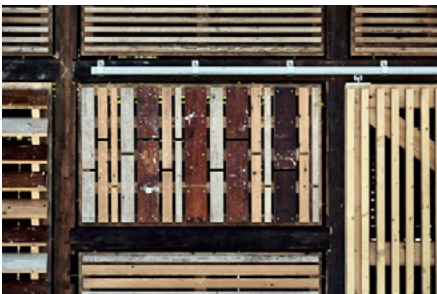


**Fig. 7.38.** Internal view (Photo: Jonathan Weimar).

### Design and structural principles

The idea is to unite the traditional Danish building custom – timberwork and large roofs with overhangs that protect the facade, with prefabrication and fast assembly (Figs. 7.39 and 7.40).

It is attractive to recycle the large quantities of rafters, laths, floorboards and roof tiles that today are thrown out as building waste during renovations in Denmark. The sheds are durable, functional and should inspire increased resource awareness when building.



**Fig. 7.39.** Module facade (Photo: Jonathan Weimar).



**Fig. 7.40.** Module facade (Photo: Jonathan Weimar).

**Materials and finishes**

Beams, rafters, floorboards, newer rafters, roof tiles, smoking tiles, gutters and mirrors. All recycled from demolitions in the Copenhagen area.

**Resources consumption in the use stage (water, energy, etc.)**

Recycled lighting fixtures with new LED inserts and motion sensor.

The solar panels are prepared to be installed in the facade so that the shed becomes self-sufficient.

**Additional information**

The idea is to develop a circular business model that can be scaled and thus have a great impact on the environment. A lot of CO<sub>2</sub> can be saved each year if you switch to building with recycled materials.

## 7.5. EXAMPLE IN FINLAND

---

### CASE STUDY: Nature Centre Haltia

---

#### General information (Figs. 7.41–7.43)

Location: Nuuksio, Espoo, Finland.

Architect: Rainer Mahlamäki, Lahdelma & Mahlamäki Architects.

Client: Timo Kukko, Nuuksiokeksus Oy.

Year of construction: 2013.

Duration of construction: Autumn 2011 – spring 2013.

Number of floors: 2–3.

Cost: EUR 16.7 million.

Nature Centre Haltia is located on the shore of Lake Pitkäjärvi and right next to Nuuksio National Park in Espoo, Finland. It is an exhibition, restaurant and conference building with estimated 200 000 visitors per year (Mahlamäki, 2013, p. 10).



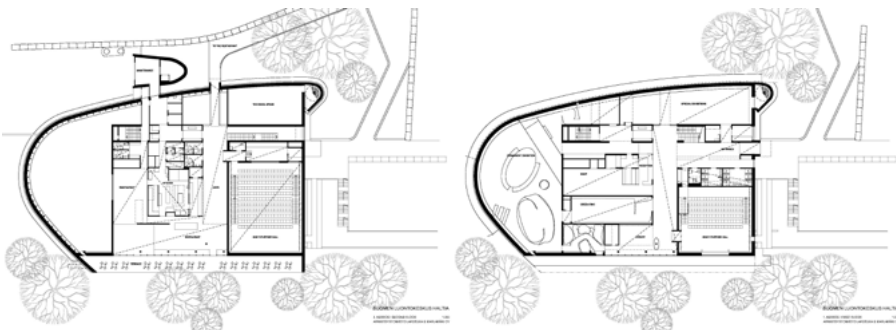
**Fig. 7.41.** Outside appearance of Nature Centre Haltia (Huisman, n.d.).

Haltia is the first public building made of CLT-elements in Finland (Haltia, 2019).

The total floor area of the building is 3 534 m<sup>2</sup>, and it was completed in 2013. The client is Timo Kukko who is the manager of Nuuksiokeskus Oy. The project manager was Juha Välikangas from Pöyry CM Oy. The architectural design was made by Professor Rainer Mahlamäki, M.Sc Architect, from Lahdelma & Mahlamäki Architects. The structural design was made by Insinööritoimisto Tanskanen Oy. The main contractor was YIT Rakennus Oy and the wood structures were made by Stora Enso and Eridomic Oy. The costs of the building were EUR 16,7 million (Mahlamäki, 2013, p. 13).



**Fig. 7.42.** Inside view of Nature Centre Haltia (Huisman, n.d.).



**Fig. 7.43.** The floor plans. Starting from the top left: second floor, first floor, and ground floor (Mahlamäki, 2013, p. 11).

## Design and structural principles

The inspiration for the Haltia architecture came from the Kalevala, the national epic of Finland and Karelia (Haltia, 2019) (Asplund & Mettomäki, 2017). The whole structure is designed by one architect, so it has a uniform design. The cornerstones for Haltia are ecology and environment, functionality, and technical advancement (Haltia, 2019).

Haltia is the first public building in Finland where everything is made of cross laminated timber (CLT) (Haltia, 2019). Also, the load-bearing structure is made of CLT panel elements (Mahlamäki, 2013, p. 15).

The curving lines that meet rectangular shapes symbolize the encounter between nature and human environment. With these different shapes Haltia shows the possibilities of wood construction, which are shown with different wooden joints, on site and prefabricated elements, and traditional and modern wood treatment methods (Haltia, 2019) (Fig. 7.44).



Fig. 7.44. Three different kind of shapes in Haltia (Huisman, n.d.).

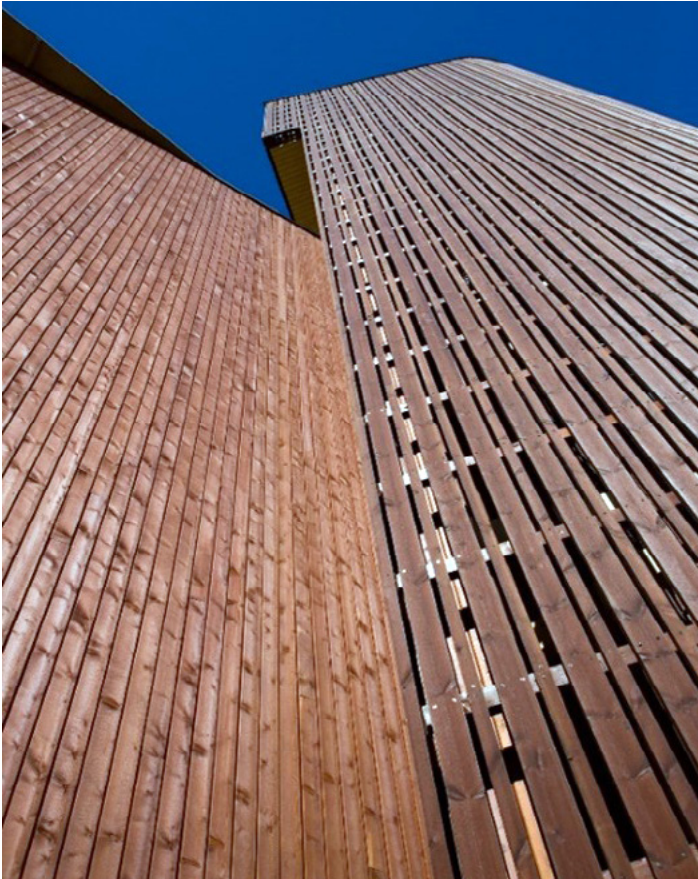
## Materials and finishes

The CLT-elements have been supplied from Stora Enso's Austrian factories as raw plates. The boards are made of Austrian spruce because CLT was not produced in Finland during Haltia's construction. They are glued together with an emission free M1 grade urethane adhesive. They were finished in Pälkäne, where, for example, the insulations were added (Haltia, 2019).

The facade is made of pine saturated with quartz sand. It does not contain any harmful substances and it is fire resistant and as durable as wood saturated



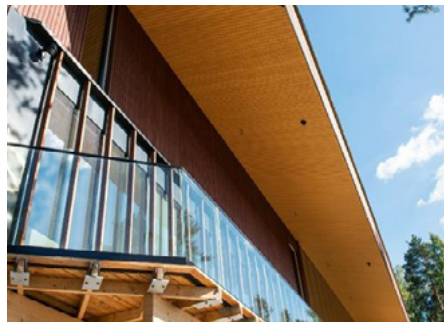
with arsenic. Haltia is the first building in the world where this material has been used for exterior trim (Haltia, 2019) (Figs. 7.45–7.47).



**Fig. 7.45.** Facade (Haltia, 2019).



**Fig. 7.46.** Different sized panels to create a rhythmic design (Siparila, 2018).



**Fig. 7.47.** Surface treatment gives the possibility to achieve harmonious colours (Siparila, 2018).

### Resources consumption in the use stage

The whole building is designed to consume as little energy as possible (Fig. 7.48). The round shape of the building makes the building envelope small in relation to its volume. Also, the lowest floor is underground, which makes the heat loss smaller. The terrace is located so that it shades the lower floors, which keeps them cool during summer. The number of windows is small, so the heat loss is smaller (Haltia, 2019).

The aim in heating Haltia is that it is 75 per cent self-sufficient in heating and 100 per cent self-sufficient in cooling. This is reached by a ground source heat pump with 15 bore wells, which reach a depth of 250 metres. They contain geothermal pipes that are 11 kilometres long. These are used for both heating during winter and cooling during summer (Haltia, 2019).

There are evacuated tube collectors on the roof of Haltia. The transfer fluid, which is heated with the rays of sun, is used to support the ground source heating. When the collectors give more heat than needed, it is directed to the base rock (Haltia, 2019).

The ventilation and water use are controlled by automatic systems. This makes sure that no water is wasted and that the ventilation is on only in spaces that are in use. The water is mainly heated with the sun collectors and the geothermal energy (Haltia, 2019).

### Additional information

Haltia was given the first sustainable development award by European Museum of the Year competition in 2015 (Haltia, 2019).



Fig. 7.48. Solar panels on the roof (Kuvataivas, n.d.).

## 7.6. INTERNATIONAL EXAMPLES

---

### 7.6.1. CASE STUDY 1: Children's Village, boarding school

---

#### General information (Figs. 7.49–7.52)

Location: Formoso do Araguaia, TO, 77470-000, Brazil.

Architects: Aleph Zero, Rosenbaum.

Design Team: Adriana Benguela, Gustavo Utrabo, Pedro Duschenes, Marcelo Rosenbaum.

Client: Fundação Bradesco.

Year of construction: 2017.

Number of floors: Two.

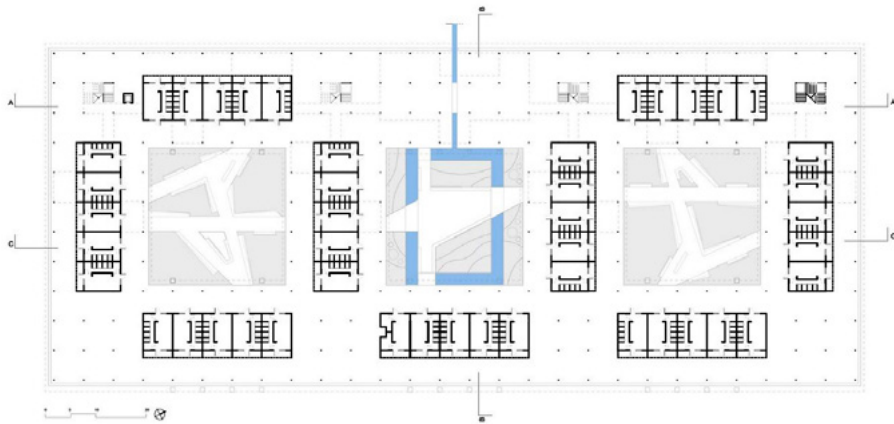


Fig. 7.49. Exterior appearance (Leonardo Finotti – [www.archdaily.com](http://www.archdaily.com)).





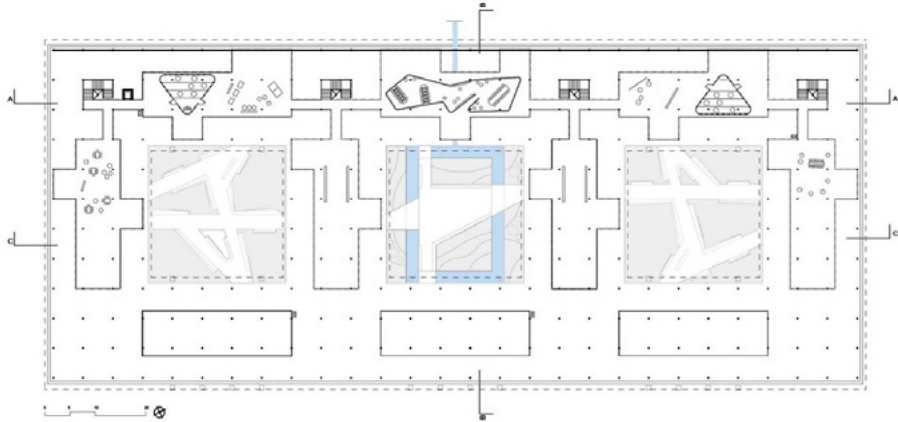
**Fig. 7.50.** Interior view (Leonardo Finotti – [www.architecture.com](http://www.architecture.com)).



**Fig. 7.51.** Ground floor plan (Leonardo Finotti – [www.archdaily.com](http://www.archdaily.com)).

### Design and structural principles

Two identical structures (one for boys and the other for girls) are set at each side of the main school buildings. A large timber roof sloping from west to east is supported by glulam columns and beams. Sculptural stairs rise above these units to walkways, recreational use space and balconies separated with slatted timber screens (Figs. 7.53–7.54).



**Fig. 7.52.** First floor plan (Leonardo Finotti – [www.archdaily.com](http://www.archdaily.com)).



**Fig. 7.53.** Column with ground detail (Leonardo Finotti – [www.archdaily.com](http://www.archdaily.com)).

The natural cross-ventilation throughout the building with breathable walls, expansive shade results in no air conditioning in temperatures well over 40 °C. However, control of low temperatures at night is a problem, with extra blankets needed in the dorms.

### **Materials and finishes**

The materials used for the project include white metallic roof supported by 5.9 m × 5.9 m lightweight eucalyptus glulam grid on local eucalyptus glulam structural columns.

The accommodation uses solid form stabilised local earth blocks; to provide natural ventilation these blocks were perforated for the wash rooms.

### **Resources consumption in the use stage (water, energy, etc.)**

The main aim is providing a cool environment across the internal area of 23,344 m<sup>2</sup> during uncomfortable daily temperatures, which is well achieved as previously discussed.



**Fig. 7.54.** Columns and roof structure  
(Leonardo Finotti – [www.archdaily.com](http://www.archdaily.com)).

Due to the rural location of the school it was important to use as much pre-fabrication as possible. This also accelerated the construction speed which limits the disruption to school activities. Local materials were used with the timber frame elements as well as local earth for the blocks. For other timber elements computer numerical control (CNC) cutting provided highly accurate cutting.

### **Additional information**

Awards:

- *RIBA Award for International Excellence 2018.*
- *RIBA International Emerging Architect for Aleph Zero.*

## 7.6.2. CASE STUDY 2: Lookout restaurant Al Nahham in Banana island Doha, Qatar

---

### General information (Figs. 7.55–7.57)

Location: Banana Island, Doha, Qatar.

Architects: Project Management and Supervision Consultants Hill International.

Client: Private Engineering Office, Doha, Qatar (the current governing manager: Anantara).

Year of construction: 2014.

Duration of construction: Two years.

Height: 12.8 m.

Number of floors: One.

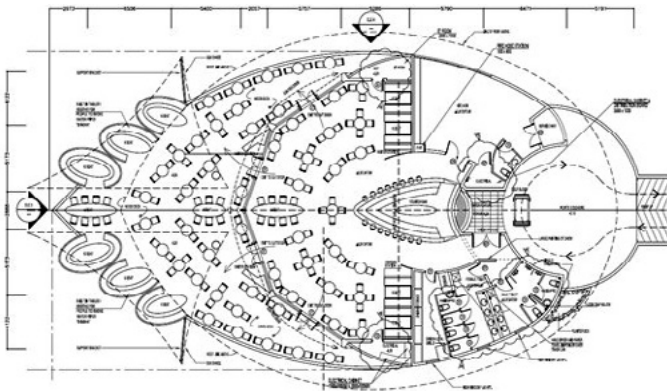


**Fig. 7.55.** The outside appearance of the lookout restaurant in Banana Island, Doha, Qatar.





**Fig. 7.56.** The inside view of the lookout restaurant in Banana Island, Doha, Qatar ([www.anantara.com](http://www.anantara.com)).



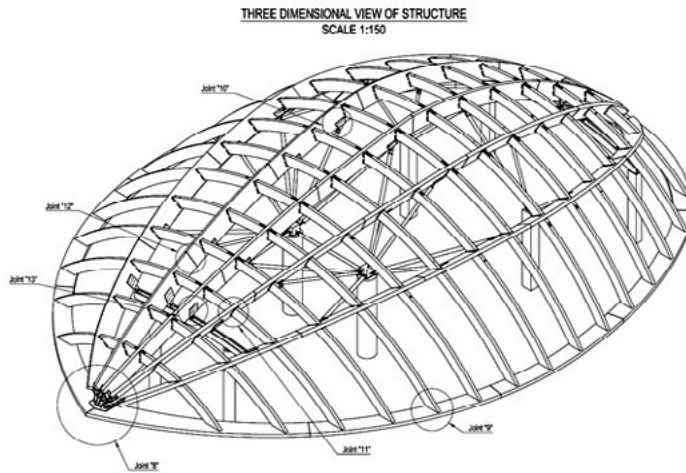
**Fig. 7.57.** The plan of the lookout restaurant in Banana Island, Doha, Qatar.

### **Design and structural principles**

The dimensions of the lookout restaurant are 43 m in length and 25.6 m in width. The three-dimensional view of the whole load bearing structure is shown in Fig. 7.58. The load bearing structure consists of rectangular and circular cross section reinforced concrete columns, circular hollow steel supporting struts, and the load bearing curved glued laminated timber arches. The reinforced concrete columns are rigidly supported to the foundation and struts are flexibly connected to the top of reinforced concrete columns. The load bearing glulam arches are supported by the steel struts. The whole roof

structure is supported only by 8 reinforced concrete columns. The cantilever of glulam arches is up to 7–8 metres.

The process of construction is shown in Fig. 7.59. Close to the construction site there are no factories which produce glued laminated timber load bearing structural elements. For this reason, the main arches with length up to 60 metres were cut into 5 separate elements with maximum dimensions up to 13 metres with the aim to fit these elements in sea containerships. For



**Fig. 7.58.** The 3-dimensional view of the lookout restaurant in Banana Island, Doha, Qatar.



**Fig. 7.59.** Construction process of the lookout restaurant in Banana Island, Doha, Qatar.

this purpose, special connections with self-tapping screws were developed. This type of connection is able to transfer bending moments, axial and shear forces. The main issue of the design of this load bearing structure was very high wind speed - 42 m/s. As timber structures are relatively light there should be some special anchoring details to fix the roof structure to the below load bearing structure.



**Fig. 7.60.** Self-tapping screws used for timber beam-to-beam connection of main glulam roof arches ([www.rothoblaas.com](http://www.rothoblaas.com); [www.sfs.biz](http://www.sfs.biz)).

The beam-to-beam connection of the main roof arch was installed using the self-tapping screws, shown in Fig. 7.60. This type of self-tapping screws does not require any predrill holes in timber and in steel plates with thickness up to 15 mm. The initial strip of the connection is avoided by using this type of screws.

### **Materials and finishes**

The roofing material was chosen a natural thatch. This roofing represents the traditional architecture in tropical countries.

As it was shown previously, the glued laminated timber elements were left unpainted, only several layers were covered with antiseptics and flame retardants. The interior of the building shows the natural view of roof timber elements.

The steel strut elements were painted with fire resistant paint.

### **Additional information**

The Al Nahham Restaurant was awarded in 2018 - World Luxury Restaurant Award. Dine in the comfort of the eye-catching restaurant designed in contemporary Arabic style (source: <https://www.luxuryrestaurantawards.com/listings/al-nahham-restaurant>).



## References

---

- Abrahamsen, R. (2017). *Mjøstårnet - Construction of an 81 m tall timber building*. Moelv, Norway: Internationales Holzbau-Forum IHF 2017.
- Archdaily.com. (2018). *Children Village by Aleph Zero and Rosenbaum Wins 2018 RIBA International Prize*. <https://www.archdaily.com/906258/children-village-by-aleph-zero-and-rosenbaum-wins-2018-riba-international-prize>
- Architecture.com. (2017). *Rievaulx Abbey Visitor Centre and Museum*. <https://www.architecture.com/awards-and-competitions-landing-page/awards/riba-regional-awards/riba-yorkshire-award-winners/2017/rievaulx-abbey-visitor-centre-and-museum>
- Architecture.com. (2018). *Children Village*. <https://www.architecture.com/awards-and-competitions-landing-page/awards/riba-international-prize/2018/children-village>
- Asplund, A., & Mettomäki, S.-L. (2017). *Kalevala: The Finnish National Epic*. <https://finland.fi/arts-culture/kalevala-the-finnish-national-epic/>
- Blindkilde, T. (2015). byensejendom.dk. *Nu-udbygges-vadehavscenteret-for-53-millioner*. <https://byensejendom.dk/article/nu-udbygges-vadehavscenteret-for-53-millioner-16528>
- Cik ātri aug mežs. (2018). *Latvian State Forests*. <https://www.youtube.com/watch?v=yeXYhN5SeH0&feature=youtu.be>
- Dorte Mandrup. (2017). *Work/wadden-sea-centre*. <https://www.dortemandrup.dk/work/wadden-sea-centre>
- e-architect.co.uk. (2017). *Rievaulx Abbey Visitor Centre & Museum Building*. <https://www.e-architect.co.uk/leeds/rievaulx-abbey-visitor-centre-museum-helmsley>
- Enemærke & Pedersen. (2019). *Genbrugskonkurrence resulterede i Danmarks smukkeste affaldsskur*. <https://eogp.dk/nyheder/genbrugskonkurrence-resulterede-i-danmarks-smukkeste-affaldsskur/>
- Gada labākā būve Latvijā 2017. (2018). *Rīga: Tipogrāfija “Dardedze hologrāfija”*.
- Haltia. (2019). *Arkkitehtuuri*. <https://www.haltia.com/fi/haltia/arkkitehtuuri/>
- Haltia. (2019). *CLT Cross laminated timber*. <https://www.haltia.com/fi/haltia/puurakentaminen/clt/>
- Haltia. (2019). *Ekoteknologia*. <https://www.haltia.com/fi/haltia/ekoteknologia/>
- Haltia. (2019). *LVI-tekniikka*. <https://www.haltia.com/fi/haltia/ekoteknologia/lammitys-ja-jaahdytys/>
- Haltia. (2019). *Puurakentaminen*. <https://www.haltia.com/fi/haltia/puurakentaminen/>
- Huisman, M. (n.d.). *Luontokeskus Haltia*. <https://www.woodarchitecture.fi/fi/projects/luontokeskus-haltia>
- Keiding, M. (2017). *Arkitekten.dk*. <https://arkitekten.dk/2017/11/vadehavscentret/>
- Krydsrum. (2019). *Krydsrum*. <http://krydsrum.dk/projekter/reskur/>
- Kuvataivas. (n.d.). *Suomen luontokeskus Haltia*. <http://www.kuvataivas.eu/-/galleries/ilmakuvat/-/medias/30cb2ed9-733a-4f65-bd70-6297f4045ebb-suomen-luontokeskus-haltia>

Gada buve. (2019). *The best building of the year in Latvia (Gada labākā būve Latvijā)*. <http://gadabuve.lv/index.php/2019/04/01/gada-labaka-buve-latvija-2018-laureati/>

Mahlamäki, R. (2013, 3). *rakennettu | projects | HALTIA*. PUU, 3/13, 8–15.

Naeste. (2019). *Næste*. <https://naeste.dk/>

Trada. (2019). *Rievaulx Abbey Visitor Centre*. <https://www.trada.co.uk/case-studies/rievaulx-abbey-visitor-centre-helmsley-yorkshire/>

Siparila. (2018). *Luontokeskus Haltia*. <https://www.siparila.fi/projektit/luontokeskus-haltia/>