



RIGA TECHNICAL
UNIVERSITY

Larisa Grackova

IMPACT OF ELECTRIC VEHICLES AND CHARGING STATIONS ON THE DEVELOPMENT OF THE LATVIAN ENERGY SYSTEM AND ENVIRONMENTAL QUALITY

Summary of the Doctoral Thesis

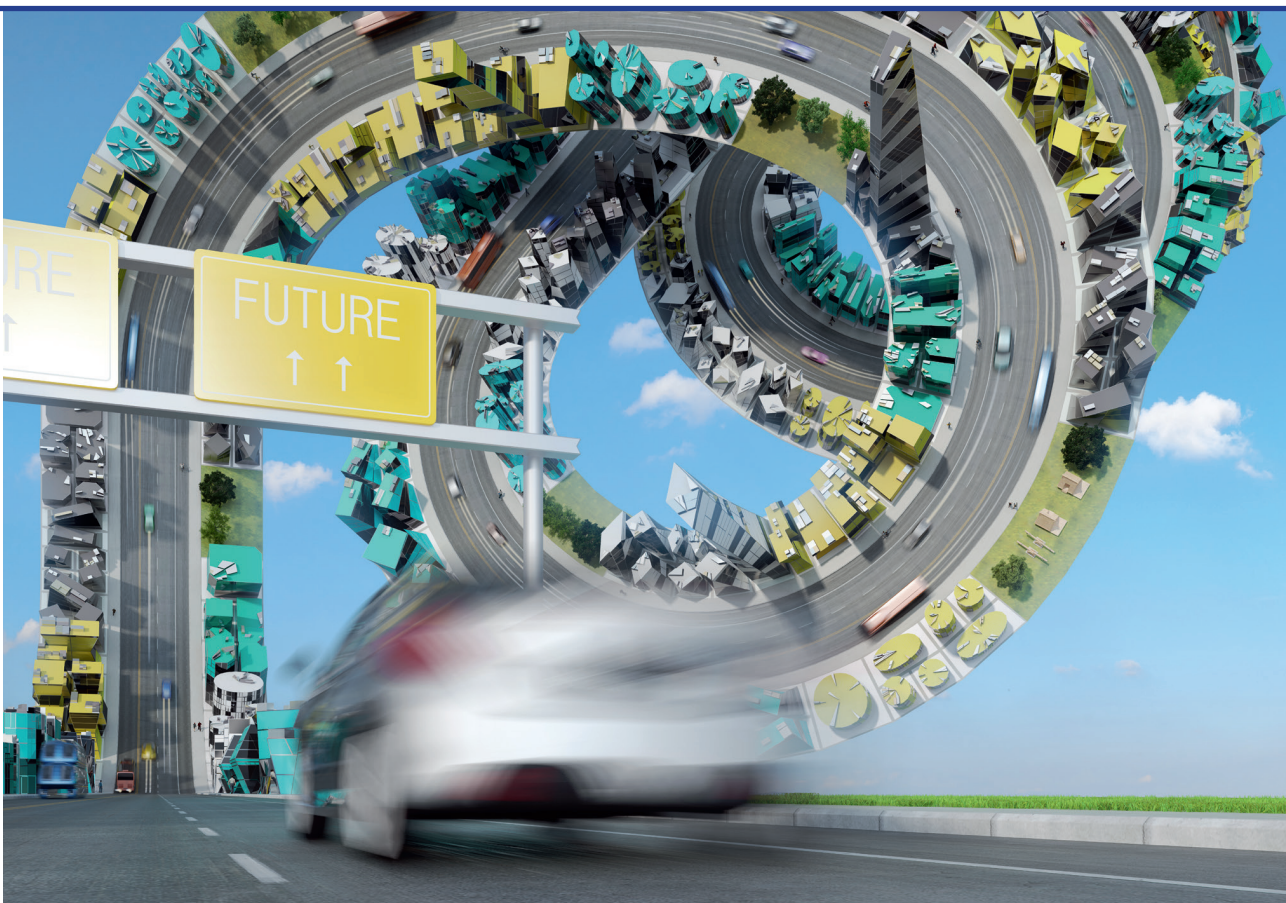

RTU Press
Riga 2018

RIGA TECHNICAL UNIVERSITY

Faculty of Power and Electrical Engineering

Institute of Power Engineering

Larisa Grackova

Doctoral Student of the Study Programme “Power Engineering”

**IMPACT OF ELECTRIC VEHICLES AND
CHARGING STATIONS ON THE
DEVELOPMENT OF THE LATVIAN ENERGY
SYSTEM AND ENVIRONMENTAL QUALITY**

Summary of the Doctoral Thesis

Scientific supervisor
Professor Dr. sc. ing.
IRINA OLEINIKOVA

RTU Press
Riga 2018

Grackova, L. Impact of Electric Vehicles and Charging Stations on the Development of the Latvian Energy System and Environmental Quality. Summary of the Doctoral Thesis. Riga: RTU Press, 2018. 51 p.

Published in accordance with the decision of the Promotion Council "P-05" (Power Engineering) of 23 October 2018, No. 49/18.



This work has been partially supported by the National Research Programme "LATENERGI".

ISBN 978-9934-22-172-9 (print)
978-9934-22-173-6 (pdf)

DOCTORAL THESIS PROPOSED TO RIGA TECHNICAL UNIVERSITY FOR THE PROMOTION TO THE SCIENTIFIC DEGREE OF DOCTOR OF ENGINEERING SCIENCES

To be granted the scientific degree of Doctor of Engineering Sciences, the present Doctoral Thesis has been submitted for the defence at the open meeting of RTU Promotion Council on 22 November 2018 at the Faculty of Power and Electrical Engineering of Riga Technical University, Azenes Street 12/1, Room 306, at 2 p.m.

OFFICIAL REVIEWERS

Professor Dr. habil. sc. ing. Antans Saulus Sauhats
Riga Technical University

Professor Dr. habil. sc. ing. Igor Kabashkin
Transport and telecommunication institute, Latvia

Professor Dr. sc. ing. Argo Rosin
Tallinn University of Technology, Estonia

DECLARATION OF ACADEMIC INTEGRITY

I hereby declare that the Doctoral Thesis submitted for the review to Riga Technical University for the promotion to the scientific degree of Doctor of Engineering Sciences is my own. I confirm that this Doctoral Thesis has not been submitted to any other university for the promotion to a scientific degree.

Larisa Grackova..... (signature)

Date:

The Doctoral Thesis has been written in English. It comprises an introduction, 4 chapters, conclusions; 56 figures; 22 tables; 3 appendices; the total number of pages is 138. The Bibliography contains 132 titles.

TABLE OF CONTENTS

1. INTRODUCTION	5
1.1. Topicality of the Doctoral Thesis	5
1.2. The Hypothesis, Goal and Objectives of the Thesis.....	5
1.3. Methods and Tools of the Research	6
1.4. Scientific Novelty of the Thesis	6
1.5. Practical Significance of the Thesis	7
1.6. The Scope of the Thesis	7
1.7. Approbation of the Doctoral Thesis	7
1.8. Structure and Volume of the Doctoral Thesis	11
2. Energy Balance, Energy System and Greenhouse Gas Emissions	12
2.1. Energy Balance as an Integrated Energy System Worldwide	12
2.2. Worldwide Greenhouse Gas Emissions	13
2.3. Analysis of Segments of the Latvian Energy Sector	14
2.4. Energy and Climate Policy of the European Union	16
3. Conditions for Operating the Distribution Networks and Planning of Electric Vehicle Charging Stations	17
3.1. Electric Vehicles and Charging Stations Worldwide	17
3.2. Overview of Public Charging Stations and Vehicles with Electric Engines in Latvia.....	18
3.3. Overview of the Research and Methodology for the Integration of Charging Stations	18
4. Evaluation algorithm of local distribution networks taking into account the placement of electric vehicle charging stations	20
4.1. The Overall Framework of the Algorithm.....	20
4.2. Description of Algorithm Methodology	22
4.3. Algorithm Testing. Effective Urban Electrical Network Infrastructure and the Development of Public EVCSs	33
5. Analysis and Development of Long-term Forecast of Energy Consumption in Latvia by 2030	44
5.1. Modelling Framework and Scenarios.....	44
5.2. Analysis and Comparison of the Results	45
Conclusions	47
Further Research	48
References	49

1. INTRODUCTION

1.1. Topicality of the Doctoral Thesis

The quality of life, work and leisure of people are completely dependent on primary energy sources in all countries of the world. Modern technical possibilities of heat and power processing are aimed not only at creating favourable living conditions, but also at applying high technological equipment in all areas of human activity.

According to the BP Statistical Review of World Energy, primary energy consumption in the period from 1965 to 2016 increased by more than 3.5 times, which had a positive impact on economic development in several sectors of the economy, but exerted a negative impact on the environment, as a result of exposure to burning fossil fuels [1].

Moreover, the consumption by the transport sector has been about 20 % of the total final consumption for a long time period. The same situation takes place in Latvia, where a large part of energy resources are consumed by the transport sector, accounting for 20–30 % of the annual final consumption of the country. In the transport sector it was 27.8 % of the total consumption in 2014, 29.7 % in 2015, and 30.3 % in 2016.

Greenhouse gas emissions in the transport sector increased by 6.1 % in 2015 compared to 2014 and decreased by 0.5 % in 2016 compared to 2015 mainly due to the road transport, since 90 % of energy resources (petrol and diesel) are consumed by the road transport [2].

Adopting documents on financing of national economy sectors, the Ministry of Economics and the Ministry of Environmental Protection and Regional Development adhere to the “European Strategy for Clean and Energy Efficient Vehicles”. The main priorities of the energy strategy are implemented: to ensure the economic efficiency by the reduced primary energy resources and the increased use of the renewable energy sources, as well as a quantitative increase of alternative fuels/technologies in road transport fleet, reducing the dependence of the transport sector on conventional fuels and climate change mitigation efforts. Electricity, hydrogen and compressed natural gas are the most commonly used alternative fuels in passenger cars, buses and light-duty vehicles (LDVs) [3].

All these aspects have determined the choice of the theme, objectives and content of the Doctoral Thesis.

1.2. The Hypothesis, Goal and Objectives of the Thesis

The aim of the Thesis is to development an algorithm for investigating the local distribution network in accordance with the technical requirements of electric transport, the charging infrastructure and services, as well as investigation of the Latvian power system consumption up to 2030, which deals with the integration of electric vehicles into electric power systems by interaction of technical, ecological and economic aspects.

To achieve the goals, the following tasks have been performed.

- Latvian and world energy balances have been evaluated and classified by sectors of production and consumption over the period from 1965 to 2016.

- Electrical charging station technologies in the world and in Latvia have been researched and analysed.
- Algorithms have been developed to simulate and evaluate the impact of users of electric vehicles on the distribution network infrastructure and power supply system as a whole in cities or districts.
- The development trends of the electric transport park in Latvia and its development potential until 2030 have been examined, taking into account the state energy policy guidelines.
- Energy balance has been developed by sectors and emissions in Latvia until 2030, with particular attention being paid to the road transport sector.

1.3. Methods and Tools of the Research

The methods and tools of the research include, but are not limited to:

- the database of the Central Statistical Bureau of Latvia;
- Eurostat database and publications;
- Statistical Review of World Energy;
- Standardization Mandate for Road Vehicles and Associated Infrastructure of World;
- Standardization Roadmap for Electric Vehicles;
- processing, analysis and graphical representation of the results in MS Excel (the mathematical statistics methods, probability theory and the simplex mathematical optimisation method for linear programming task) and MATLAB (SimPowerSystems);
- calculation of fossil fuel consumption and GHG emissions of road transport sector by COPERT 5 software;
- energy and environmental analysis of historical and prediction indicators, the development of scenarios and comparison taking into account future uncertainties by using MARKAL model.

1.4. Scientific Novelty of the Thesis

- Latvian and world energy balances have been evaluated and classified by sectors of production and consumption over the period from 1990 to 2016.
- Existing electrical charging station technologies in the world and in Latvia have been researched and analysed.
- Algorithms have been developed to simulate and evaluate the impact of users of electric vehicles on the distribution network infrastructure and power supply system as a whole in cities or districts.
- The development trends of the electric transport park in Latvia and its development potential until 2030 have been examined, taking into account the state energy policy guidelines.

- Energy balance has been developed by sectors and emissions in Latvia until 2030, with particular attention being paid to the road transport sector.

1.5. Practical Significance of the Thesis

The Doctoral Thesis addresses both fundamental science and practical issues. Its implementation will significantly contribute to the integration process of Latvia in the European research area.

The methodologies and algorithms proposed in the Thesis can be used as follows:

- by companies and organisations involved in the implementation of state policies in the road transport sector and the assessment of environment and natural resources;
- for conducting theoretical and scientific research related to rational construction of power supply systems in cities or in districts, to optimisation of parameters and development planning, taking into account the rapid development of smart grids, the introduction of new network elements and the active role of the end consumer;
- by energy companies and organisations involved in the technical assessment and development of power supply schemes in the city or its districts, design and modernisation of 0.4 kV networks and 20–10/0.4 kV transformer substations in accordance with the requirements of electric vehicle users (customers);
- for assessing the end-user’s participation in both electricity market and balancing market.

1.6. The Scope of the Thesis

To achieve the set goals, the following objectives have been formulated:

- to develop a new algorithm in order to investigate the local distribution network of a residential area and obtain the optimal solution for creating charging infrastructure on the territory of district, in accordance with the requirements of residents (owners of electric vehicles), at the same time ensuring the reliability of the power supply network in the urban or rural area;
- to evaluate and investigate the increase of electricity consumption and the reduction of fossil fuel consumption in Latvia until 2030, due to the integration of electric vehicles in the road transport sub-sector, as well as estimate the decrease of greenhouse gas emissions within the framework of the accepted national targets.

The results of the research have been partly presented in 4 projects and 18 contracts.

1.7. Appropriation of the Doctoral Thesis

The results of the research have been presented and discussed at 17 scientific conferences and published in 16 international journals and proceedings.

Conferences

1. 17th International Multi-Conference on Reliability and Statistics in Transportation and Communication (RelStat'17). Transport and Telecommunication Institute. 18–21 October 2017, Riga, Latvia.
2. 58th International Scientific Conference on Power and Electrical Engineering of Riga Technical University (RTUCON), 12–13 October 2017, Riga & Mežotne, Latvia.
3. 8th International Scientific Symposium on Electrical Power Engineering ELEKTROENERGETIKA 2017, 12–14 September 2017, Stara Lesna, Slovak Republic.
4. 57th International Scientific Conference on Power and Electrical Engineering of Riga Technical University (RTUCON), 13–14 October 2016, Riga & Cesis, Latvia.
5. 13th International Conference on the European Energy Market (EEM) FEUP, 6–9 June 2016, Porto, Portugal.
6. 15th International Multi-Conference on Reliability and Statistics in Transportation and Communication (RelStat'15). Transport and Telecommunication Institute. 21–24 October 2015, Riga, Latvia.
7. 8th International Scientific Symposium on Electrical Power Engineering ELEKTROENERGETIKA 2015, 16–18 September 2015, Stara Lesna, Slovak Republic.
8. 5th International Conference on Power Engineering, Energy and Electrical Drives. POWERENG 2015, 11–13 May 2015, Riga, Latvia.
9. 11th International Conference on the European Energy Market (EEM), 28–30 May 2014, Krakow, Poland.
10. 11th International Conference of Young Scientists on Energy Issues (CYSENI), 29–30 2014, May, Kaunas, Lithuania.
11. 3rd International Doctoral School of Electrical Engineering and Power Electronics, 23–24 May 2014, Ronishi, Latvia.
12. 71st Conference of the University of Latvia on Environmental Management. 7 February 2013, Riga, Latvia.
13. 5th Scientific and Practical Seminar “The Economic Security of the State and the Scientific and Technological Aspects of its Provision”, 21–22 October 2013, Kiev, Ukraine.
14. 2nd International Doctoral School of Electrical Engineering and Power Electronics, 24–25 May 2013, Ronishi, Latvia.
15. 54th International Scientific Conference on Power and Electrical Engineering of Riga Technical University (RTUCON), 14–16 October 2013, Riga, Latvia.
16. 4th Scientific and Practical Seminar “The Economic Security of the State and the Scientific and Technological Aspects of its Provision”, 23–26 October 2012, Dnepropetrovsk, Ukraine.
17. 70th Conference of the University of Latvia on Environmental Management. 9 February 2012, Riga, Latvia.

Publications

1. A. Fedotov, R. Basirov G. Vagapov, L. Abdullin, **L. Grackova**. Detection of places of single-phase ground fault by frequency of the resonance. *59th International Scientific Conference on Power and Electrical Engineering of Riga Technical University (RTUCON)*. 12–14 November, 2018, Riga, Latvia. (ACCEPTED 03.09.2018).
2. **L. Grackova**, I. Oleinikova, G. Klavs. Modelling the location of charging infrastructure for electric vehicles in urban areas. *The 17th International Multi-Conference on Reliability and Statistics in Transportation and Communication (RelStat'17)*. Transport and Telecommunication Institute. 18–21 October 2017, Riga, Latvia, pp. 54–64, https://link.springer.com/chapter/10.1007/978-3-319-74454-4_5.
3. **L. Grackova**, A. Zhiravetska, I. Oleinikova, G. Klavs. Aspects of effective urban electrical network infrastructure development for the introduction of electric vehicles charging stations. *58th International Scientific Conference on Power and Electrical Engineering of Riga Technical University (RTUCON)*, 12–13 October 2017, Riga & Mežotne, Latvia. RTUCON, pp. 1–6, (Indexed in Scopus).
4. **L. Grackova**, I. Oleinikova, G. Klavs. Algorithm-based analysis for the charging stations impact evaluation on the low-voltage distribution networks. *Proceedings of the 9th International Scientific Symposium on Electrical Power Engineering ELEKTROENERGETIKA 2017*, 12–14 September 2017, Stara Lesna, Slovak Republic, pp. 580–584.
5. A. Fedotov, R. Abdullazyanov, G. Vagapov, **L. Grackova**. Detection of places of single-phase ground fault by frequency of the resonance. *57th International Scientific Conference on Power and Electrical Engineering of Riga Technical University (RTUCON)*, 13–14 October 2016, Riga & Cesis, Latvia.
6. **L. Grackova**, I. Oleinikova. Impact of electric vehicle charging on the urban distribution network. *57th International Scientific Conference on Power and Electrical Engineering of Riga Technical University (RTUCON)*, 13–14 October 2016, Riga & Cesis, Latvia.
7. **L. Grackova**, I. Oleinikova, G. Klavs. Electric vehicles charging simulation for an urban distribution network's service sector. *13th International Conference on the European Energy Market (EEM)*, 6–9 June 2016, Porto, FEUP, Portugal. INSPEC Accession Number: 16192069, DOI: 10.1109/EEM.2016.7521184., ISSN: 2165-4093, <http://ieeexplore.ieee.org/document/7521184/>
8. **L. Grackova**, I. Oleinikova, G. Klavs. Electric vehicles in the concept of smart cities. *5th International Conference on Power Engineering, Energy and Electrical Drives*. 11–13 May 2015, Riga, Latvia, LF-002313. CDROM.
9. **L. Grackova**, I. Oleinikova, G. Klavs. The planning of electric vehicle charging in the urban network. *Proceedings of the 8th International Scientific Symposium on Electrical Power Engineering ELEKTROENERGETIKA*, 16–18 September 2015,

- Stara Lesna, Slovak Republic, pp. 188–191, ISBN 978-80-553-2187-5, CDROM, (Indexed in Web of Knowledge).
10. **L. Grackova**, I. Oleinikova, G. Klavs. Role of electrical vehicles for improvement of electrical networks efficiency. *11th International Conference of Young Scientists on Energy Issues. CYSENI 2014*, 29–30 May 2014, Kaunas, Lithuania, ISSN 1822-7554-015, p. 9.
 11. **L. Grackova**, I. Oleinikova. Economic motivation for electric vehicles participation in power market. *11th International Conference on the European Energy Market (EEM)*, 2014, 28–30 May 2014, Krakow, DOI:10.1109/EEM.2014.6861224, Publisher: IEEE. p. 5.
 12. **L. Grackova**, I. Oleinikova, G. Klavs. Charging of the electric vehicles in private sector: Technical and economic aspects. *Latvian Journal of Physics and Technical Sciences*, ISSN 0868-8257, 2014, No. 6 (Vol.51) pp. 3–12, DOI: 10/1515/lpts-2014-0032.
 13. **Грачкова, Л. В.**, Клавс, Г. И. Оценка воздействия отдельных мероприятий на сдерживание выбросов от автотранспорта. Экономическая безопасность государства: междисциплинарный подход: коллективная монография под научной редакцией д.э.н., профессора Хлобыстова Е.В. –Черкассы: издатель Чабаненко Ю.А., 2013, 642с. стр.183–188.
 14. **L. Grackova**, G. Klavs. Factors of greenhouse gas emissions reduction in the road transport of Latvia. *Latvian Journal of Physics and Technical Sciences*, ISSN 0868-8257, 2013, No. 1(Vol. 50), pp. 3–9, DOI: 10.2478/lpts-2013-0001.
 15. **L. Grackova**, I. Oleinikova. Implementation of electric vehicles for fossil fuel reduction. *54th International Scientific Conference of Riga Technical Engineering. Section of Power and Electrical Engineering. Digest book and electronic proceedings*. RTU Press, Riga, 2013. pp. 68–70.
 16. **Грачкова, Л. В.**, Клавс, Г. И., Рекис, Я. И. Оценка влияния мероприятий по сдерживанию парниковых газов от автотранспорта. IV научно-практический семинар: Экономическая безопасность государства и научно-технологические аспекты ее обеспечения, Под ред. У. М. Письменный, В. М. Шаповал. Днепропетровск. Национальный Горный Университет. 2012, 205 с. стр.41–45.

1.8. Structure and Volume of the Doctoral Thesis

The Doctoral Thesis is written in English, it contains Introduction, four chapters, Conclusions, Further Work, and Bibliography containing 132 reference sources. The total number of pages is 142, including 56 figures, 22 tables and 3 appendices.

Introduction proves the topicality of the subject of the research, defines its main goals and objectives, the scientific novelty and practical significance. It also provides the list of publications and conferences the research has been presented at.

Chapter 1 describes Latvian and world Energy Balances, Energy system and Greenhouse Gas Emissions over the period from 1965 to 2016, and it considers the priority tasks of the European Union for the development of the energy sector, which is focused on the problems of energy supply and environment.

Chapter 2 contains the analysis of the world and Latvian scientific studies and the mathematical models used to predict and control a distribution network, as well as conduct research on the development of electrical vehicle areas.

The analysis has revealed that the research on the formation of the infrastructure of charging stations in cities and settlements is of utmost importance and should be based on the existing available capacity of low-voltage distribution network and the location of different types of charging stations.

In Chapter 3, the structure of the algorithm has been considered. Its four stages are described in order to study a local distribution network taking into account the placement of the electric vehicle charging station. At all the stages, specific tasks have been solved and implemented. For completeness and accuracy studies, the algorithm is presented together with a test case.

Chapter 4 has examined the time period of 2000–2030 during which it has been found that if the road transport fleet consists of 20 % of electric vehicles, the goal set regarding GHG emissions for 2030 will be fulfilled. The study takes a scenario approach.

Conclusions and Further Work contain the proposals in four directions:

- the new algorithm described in the research should be adapted to the existing distribution network and planning tools for its application in the future;
- it is necessary to create blocks where a smart tariff plan controls the charging of an electric vehicle within 24 hours;
- it is planned to create a new block, where generation from renewable energy sources (such as solar, wind energy, and others) will be calculated and taken into account when estimating additional capacity in the area;
- the algorithm will be expanded with more additional factors and criteria to improve real-time applicability situations.

2. ENERGY BALANCE, ENERGY SYSTEM AND GREENHOUSE GAS EMISSIONS

2.1. Energy Balance as an Integrated Energy System Worldwide

According to the BP Statistical Review of the World Energy Consumption, global consumption of energy resources has increased more than 3.5 times over the past fifty years. Up to the year 2000, the world energy resources had been consumed as follows: more than 60 % – by North America, Europe and Eurasia regions, less than 30 % – by Asia Pacific, and about 10 % – by South and Central America, Middle East and Africa [4].

Oil, gas and coal were the primary energy carriers of global demand over the considered period of time (see Fig. 2.1). In the graph, the dynamics of consumption of energy resources is shown by the type of energy. It shows a slow shift towards a decrease in the consumption of hydrocarbons and looks as follows.

- **1965:** 40.9 % oil, 37.6 % coal, 15.7 % gas, 5.6 % hydro, 0.2 % nuclear, and 0 % renewable energy sources.
- **2000:** 38.2 % oil, 25.3 % coal, 23.3 % gas, 6.4 % hydro, 6.2 % nuclear, and 0.6 % renewable energy sources.
- **2015:** 32.9 % oil, 29.2 % coal, 23.9 % gas, 6.8 % hydro, 4.4 % nuclear, and 2.8 % renewable energy sources.
- **2016:** 34.4 % oil, 28.0 % coal, 23.2 % gas, 6.9 % hydro, 4.5 % nuclear, and 3.1 % renewable energy sources.

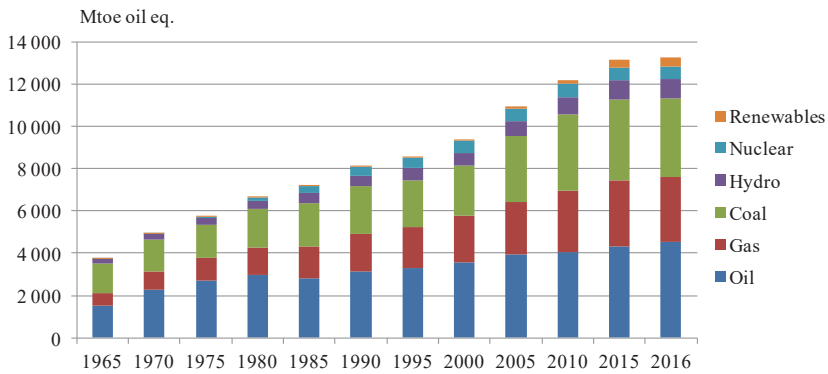

Fig. 2.1. World primary energy consumption by the type of resources.

BP Statistical Review of World Energy (BC SRWE) also shows the structure of an average annual growth rate in 1965–2016. As for the type of energy resources, there is a great difference in the average annual growth figures in the periods from 1965 to 1999 and from 2000 to 2016. In the BC SRWE Report on the Average Annual Growth, they are distributed as follows: between 1965 and 1999, 2.58 % of oil is consumed, 3.85 % of gas, 1.48 % of coal, 3.14 % of hydro, 15.06 % of nuclear sources, and 12.07 % of renewable energy sources (wind, solar, geothermal and biomass); between 2000 and 2016, 1.25 % of oil is consumed, 2.56 % of gas, 3.30 % of coal, 2.63 % of hydro, 0.17 % of nuclear sources, and 13.74 % of renewable energy sources.

Thus, it may be concluded that many world regions are dependent on imports of fossil fuels as their domestic resources are depleted or extraction is too costly.

2.2. Worldwide Greenhouse Gas Emissions

The historical data suggest that over the last fifty years, from 1965 to 2016, global CO₂ emissions almost tripled, from 11357.79 Mt to 33017.6 Mt, as it is shown in Fig. 2.2. Between the years 2000 and 2016, a significant growth by 8,301.8 Mt or 107.6% was recorded in Asia Pacific. Other facts of growth by more than 400 Mt were registered in the Middle East (966.3 million tonnes, 88.5 %), South and Central America (411.3 million tonnes, 44.9 %) and Africa (412.3 million tonnes, 53.4 %). Decline in CO₂ emissions was registered as follows: in North America – by 723.7 million tonnes, or 10.5 %; in Europe and Eurasia – by 353.8 million tonnes, or 5.3 %.

Comparison of indicators for the years 2000 and 2016 shows an increase of 37.6 %, but from 2014 to 2015 there was a decline of 0.12 %, which suggests that the tendency for decrease in global annual emissions of CO₂ can either continue or stabilize. It proves that even under the conditions of steady growth of energy consumption there is a possibility to slow down and harness the growth of emissions.

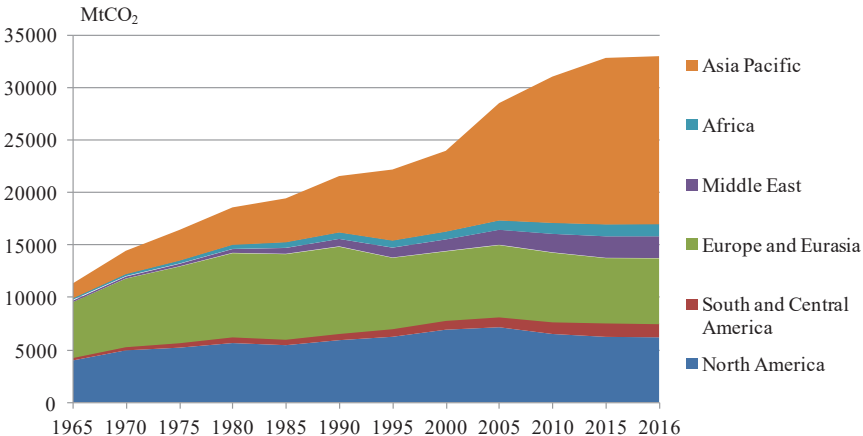

Source: BP Statistical Review of World Energy 2018, www.bp.com/

Fig. 2.2. World CO₂ emissions in the world regions, 1965–2016.

2.3. Analysis of Segments of the Latvian Energy Sector

2.3.1. Overview of the Energy System and Energy Balance of Latvia

The energy balance data for Latvia between 1990 and 2016 show the state of economic development of the country over this time period (see Fig. 2.3). By 2000, the main indicators of the gross inland energy consumption and the final energy consumption of the country had fallen by half. Then, over the following sixteen years, a gradual increase in production and consumption was observed. In 2016, gross inland energy consumption rose by 12.7 % and final energy consumption rose by 17.7 % compared to 2000 [5].

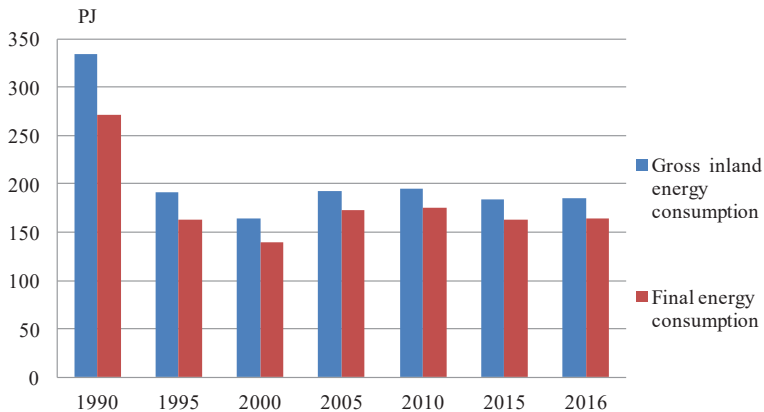

Fig. 2.3. Energy balance of Latvia: Gross inland energy consumption and final energy consumption, 1990–2016.

It should be noted that the final energy consumption figures include the amounts of energy consumed in different sectors of the country's economy, which are agriculture, residential, transport, industry, commercial and others. Over the last eleven years, the final energy consumption figures did not change notably. In 2010, the final energy consumption figure was 1.9 % higher than in 2005 (3.32 PJ), while in 2016, the final energy consumption (11.5 PJ) dropped by 6.6 % as compared to 2010. The share of economic sectors in the final energy consumption figures in Latvia from 1990 to 2016. By 2005, significant changes had come about in different sectors of the national economy. In 2005, 2010, 2015 and 2016, the percentage the final consumption in sectors was as follows.

- **In 2005**, the share of agriculture sector was 3.1 %, industry sector – 18.7 %, residential sector – 36.5 %, transport sector – 26.6 %, and the share of the commercial and other sectors was 15.1 %.
- **In 2010**, the share of agriculture sector was 3.5 %, industry sector – 19.9 %, residential sector – 33.1 %, transport sector – 29 %, commercial and others sectors – 14.6 %.
- **In 2015**, the share of agriculture sector was 4.0 %, industry sector – 21.8 %, residential sector – 29.9 %, transport sector – 29.7 %, the share of the commercial and others sectors was 14.6 %.

- In 2016, the share of agriculture sector was 4.3 %, industry sector – 20.7 %, residential sector – 29.2 %, transport sector – 30.3 %, the share of the commercial and others sectors was 15.4 %.

Analysis of the structure of energy consumption by sector reveals that the transport and residential sectors account for more than 60 % of total consumption. Although such percentage of energy consumption in these sectors remains rather stable, it must be pointed out that the figure for the residential sector has an average annual decline of 2.1 %, in the transport sector it has increased by approximately 1.2 %.

The transport sector includes the following sub-sectors: road transport, railway, civil aviation and domestic navigation. The main energy resource prevailing in the transport sector is oil products, which is shown in detail in the Annual Report of the Central Statistical Bureau (CSB). The highest energy consumption is observed in the road transport; it amounts to as much as 85 %.

2.3.2. Greenhouse Gas Emission Inventory, Latvia

In 2016, total GHG emissions were reduced by 57.3 % compared to 1990 (base year). Consequently, the following trends can be observed in the sectors: a decrease of 62.7 % in the energy sector; an increase of 8.3 % in the IPPU sector and LULUCF sector; a decrease of 52.5 % in agriculture sector; an increase of 3.8 % in the waste sector. It is worth emphasising that the energy sector is the most significant source of GHG emissions, with 60–80 % share of the total emissions between 1990 and 2016. Relative contribution of the activity sectors in total GHG emissions by sector in 2016 is presented in Fig. 2.4.

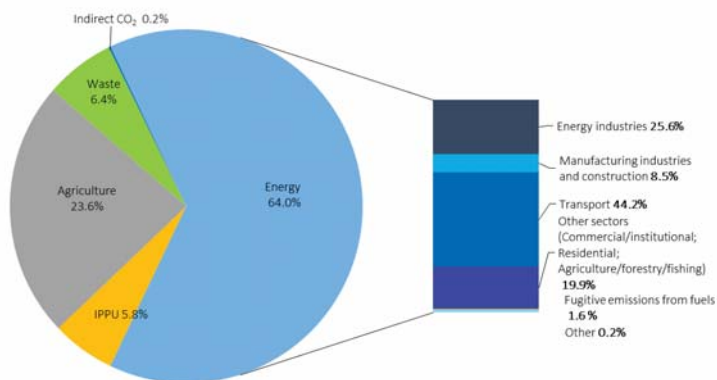

Fig. 2.4. Relative contribution of the activity sectors in total GHG emissions by sector in 2016.

In 2016, the greatest share of the GHG emissions, with 44.2 % of emissions in the energy sector, comes from the transport sub-sector, where 90 % of emissions are generated by road transport. Civil aviation, road transport, railways and domestic navigation are included in the transport sub-sector. As shown in Fig. 2.5, between 1990 and 2016 there was an annual

increase of emissions, which came from road transport, the contribution of which was more than 90 % of the total emissions of the sector. In 2016, total GHG emissions from the transport sub-sector increased by approximately 5.1 % compared to 1990, whereas in 2007 the increase was as high as 27.4 %.

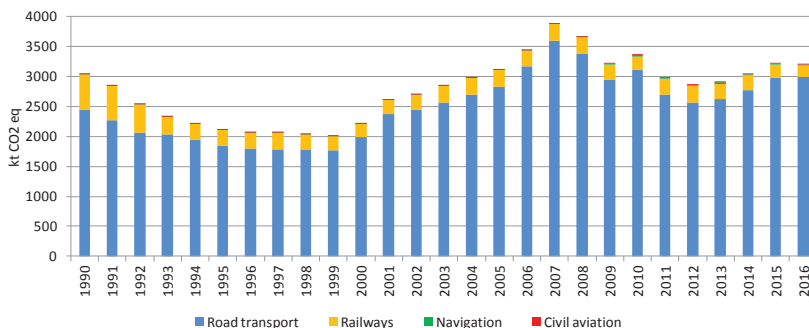

Fig. 2.5. GHG emission trends in the transport sector in 1990–2016, kt CO₂ eq.

2.4. Energy and Climate Policy of the European Union

In 2009, the European Union adopted the climate and energy package, which is a set of binding legislation and instruments aimed at reducing greenhouse gas emissions progressively up to 2050. The key climate and energy targets are set in the following packages:

- 2020 Climate and Energy Package [6];
- 2030 Climate and Energy Framework [7].

To achieve the goals, comprehensive strategies “Transport 2050” and “White Paper on Transport COM (2011)” were also accepted. In the context of these principles, the government of Latvia has adopted specific documents: “Latvian National Development Plan for 2014–2020”, “Latvian Sustainable Development Strategy 2030” and “National Reform Programme Strategy “EU 2020””, which are aimed at improving energy efficiency of apartment buildings, public and industrial buildings, infrastructure and municipal public premises, heat- and power-saving measures and use of alternative fuels in the transport sector [8], [9].

Models and Tools of Energy Systems Analysis. The analytical models and tools of energy systems analysis, such as BALMOREL, EMPS, MESSAGE, MiniCAM, PERSEUS, RAMSES, WILMAR Planning Tool, MARKAL (TIMES), EnergyPlan, Mesap and others, offer solutions for the design of least-cost pathways of sustainable energy systems, compilation of long-term energy scenarios and the preparation of low-emission development strategies [10]. In Latvia, some models and tools have been used for academic programmes and research projects, namely: MESAP, MARKAL (TIMES), MESSAGE, and EFOM [11].

3. CONDITIONS FOR OPERATING THE DISTRIBUTION NETWORKS AND PLANNING OF ELECTRIC VEHICLE CHARGING STATIONS

3.1. Electric Vehicles and Charging Stations Worldwide

According to the Global Outlook 2017, 750 thousand units of new EVs were sold worldwide in 2016. Successful sales started in 2010. If less than 2 thousand EVs were sold in 2005, more than 12.48 thousand in 2010, and the number of electric cars (BEVs and PHEVs) exceeded the mark of 1.26 million in 2015 [12], [13]. It should be noted that during these years BEVs (60 %) and PHEVs (40 %) are relatively evenly distributed. The evolution of the EV market all over the world from 2010 to 2016 has shown that in countries such as China, Japan, Norway and the Netherlands 80 % of their total number were registered in 2016.

Infrastructure for electric vehicle network is best developed in the countries where there is an annual increase in the number of electric vehicles, so the world leaders are the USA, China and Japan. In Europe, Eurasia & European regions, such countries are France, the Netherlands, Germany, the United Kingdom and Norway. A review of public charging stations, differentiated in power and charging speed in some of the European countries, showed that in Norway, Denmark and France more than 70 % of stations are standard charging stations. In the Netherlands, the United Kingdom and Germany, more than 53 % of stations are the accelerated charging stations. Regarding rapid charging, the average indicator is about 10 % of the total number in these countries. An exception is the network of charging stations in Estonia, where the accelerated and rapid charging stations account for 96 % [14]. Electric vehicles outnumber public charging stations, indicating that most drivers rely primarily on private charging stations (standard charging, slow). The main characteristics of electric vehicle battery are charging time, power demand and the rate of charge (see Table 3.1).

Table 3.1

Charging Station Modes. Standard Charging Power Levels [15]–[17]

Charging mode	Connection mode (Grid connection)	Alternating (AC) and direct current (DC), voltage (V) / current (A)
Standard charging (slow) – StEVCS: nominal power 3 kVA (1-phase) and 7 kVA (3-phase), 6–12 h	Mode 1 (1 phase / 3 phase) and Mode 2 (1 phase / 3 phase)	230/16 and 400/16 230/32 and 400/32
Accelerated charging (medium) – AcEVCS: nominal power 7–22 kVA (1- or 3-phase, 32 A), 1–4 h	Mode 3 (1 phase / 3 phase)	230/32 and 690/250
Rapid charging (fast) – RapEVCS: nominal power 50 kVA (DC) and 43kVA (AC), 80 %, < 1 h	Mode 4 (3 phase)	600/400

The analysis by the International Energy Agency (IEA), based on the projections of the leading national targets of world countries, as determined by automobile manufacturers and research scenarios, foresees that the number of EVs (passenger cars and light goods vehicles up to 3.5 tonnes) will be from 9 to 20 million in 2020, from 40 to 70 million in 2025, and from 55 to 200 million in 2030.

3.2. Overview of Public Charging Stations and Vehicles with Electric Engines in Latvia

In 2014, using the funds provided by the National Climate Change programme, the Ministry of Environmental Protection and Regional Development of the Republic of Latvia held a project contest for reducing the amount of greenhouse gas emissions in the road transport sector. As a result of the held contest, during the period of 2014–2015 there had been additional funding given for acquiring almost 200 EVs and for deals for installing 235 public charging stations by 2023 [18]. Currently, the number of public charging stations in the territory of Latvia is approximately two times larger than in 2014, and it is evident that the market of electric vehicles and the infrastructure for public charging stations will broaden [19]. As part of the public procurement of RTSD, an analysis of the location of fast charging stations near the main highways has been made. It is planned that the distance between the charging stations will be from 30 to 50 km [21]. As of 1st January 2018, 275 EV and 37 PHEV passenger cars have been registered in Latvia, where Volkswagen e-up and Nissan are the most popular EV models [20]. The total number of vehicles with electric engines is shown in Table 3.2.

Table 3.2

Number of Vehicles with Electric Engines in Latvia, 2011–2017

Type	2011	2012	2013	2014	2015	2016	2017
Passenger cars	2	11	18	192	223	268	368
Light commercial vehicles	2	2	2	6	7	11	13
Buses	0	0	0	0	0	0	1
Motorcycles	0	0	0	0	3	3	5
Mopeds/quadracycle	0	0	0	50	56	58	75
Total	4	13	20	248	289	340	462

3.3. Overview of the Research and Methodology for the Integration of Charging Stations

Before proceeding to the Doctoral Thesis, the author has studied modern technical and theoretical studies. They reflect different positions and approaches to solve the set goals, and suggest possible actions to ensure the reliability of electrical network and national environmental safety in the context of the widespread use of vehicles with electric engines.

It is important to indicate that eighteen scientific studies have showed that such sub-sectors as road transport, electricity generation and distribution of electricity to the consumer are of considerable theoretical and practical importance in all regions of the world.

Particular attention has been devoted to the mathematical models used to predict and control a distribution network as well as conduct research on the development of electrical vehicle. To establish algorithms and models of EV infrastructure, the researchers from different countries have used the following attributes as constraints: provision of the population with vehicles, the average daily mileage of a vehicle, the distance between destinations, number of individual trips, opening hours and parking lot availability, technical indicators of the distribution network, etc.

4. EVALUATION ALGORITHM OF LOCAL DISTRIBUTION NETWORKS TAKING INTO ACCOUNT THE PLACEMENT OF ELECTRIC VEHICLE CHARGING STATIONS

4.1. The Overall Framework of the Algorithm

An algorithm for studying a low-voltage distribution network in urban and rural areas has been developed in the present Thesis in accordance with the needs of charging stations.

The main tasks of the algorithm are as follows.

- To estimate the power load of the local distribution network and the possible additional load for the daily time intervals.
- To choose the location of charging stations, taking into account the behaviour of car owners at the parking places within 24 hours and the existing electric power load of the local distribution network.
- To choose the location of charging stations, taking into account their interaction with the energy company, including economic and environmental components.
- To investigate the distribution network in accordance with the needs of charging stations, as elements of an intelligent network (smart grid).
- To test the methodology of algorithm for verifying the accuracy of the equalization of peak loads in the existing distribution network and increasing its reliability and efficiency under the condition of additional load from charging stations.

The algorithm consists of four steps. The configuration is shown in Fig. 4.1. Each step is implemented to solve specific tasks and has the following phases: input, calculation, analysis and decision.

The goal of **Stage 1** is to determine the existing demand of the local area network and capabilities for additional load according to time intervals of the day.

The Input Phase gathers the necessary data about the distribution network and system elements that can be later used during the calculation phase.

Calculation Phase: the quantitative and qualitative parameters of all objects that are needed for analysis are calculated.

Analytical Phase provides new information that can be used in the current test as well as in repeated research steps. The information is summarised in data 1. This phase also considers two possibilities, if $S_{add} > 0$ and if $S_{add} < 0$.

Decision Phase determines the transition to the second stage. There are two different decision phase steps. If $S_{add} < 0$, we return to Input Phase or Stop. If $S_{add} > 0$, we proceed to Stage 2.

During **Stage 2**, to determine the location and type of the charging station, the optimal model of charging station placement is used. The simplex mathematical optimisation method for linear programming task is used for this purpose.

Input Phase: $S_{add} > 0$ value and the optimal model for the charging station location (see Chapter “Algorithmic Description of the Methodology”).

Calculation Phase evaluates the total electrical load in the area under consideration for all types of charging stations (slow charging, quick charging and super fast charging).

Analysis Phase compares the total electrical load obtained from electric vehicle charging stations (EVCSs) with potential additional loads for transformer substations. If the $S_{EVCS} \leq S_{add}$ is fulfilled, then there is a transition to the Decision Phase. The Decision Phase determines the transition to Stage 3 or the return to Stage 1 (Input Phase).

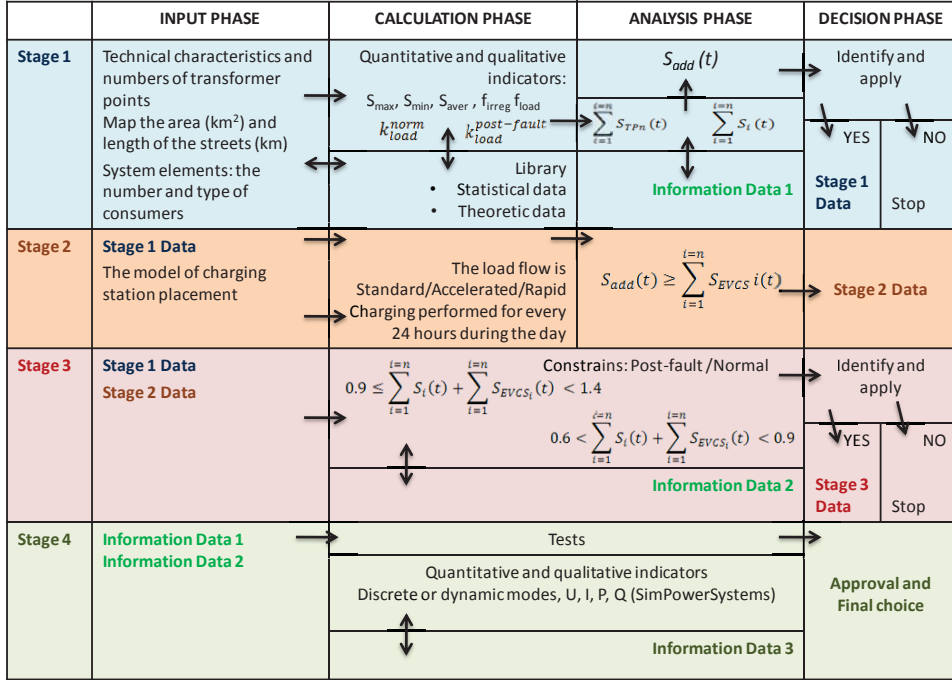

Fig. 4.1. The overall framework of the algorithm.

During **Stage 3**, data of Stage 1 and Stage 2 are combined as the Input Phase. According to the Electrical Codes and Standards, the technical characteristics of transformer substations are verified, which compare the total capacity of objects with the permissible load of the transformers in the post-fault and normal modes. The information is summarised in Data 2, which is used as a current test as well as in the course of repeated research.

The Decision Phase has two different decisions: YES and NO. If the conditions are not met, we return to Stage 1 Data. If the conditions are met, we proceed to Stage 4.

Stage 4 is algorithm validation. Input Phase: Data from information blocks of Stage 1 and Stage 3 (Data 1 and Data 2). The Calculation Phase and Analysis Phase are combined. The validation of the data of the qualitative and quantitative parameters is carried out according to

Stage 1. The Analysis Phase explores the quantitative and qualitative indicators, as they have to correspond to their possible practical application.

In addition, Simulink software (MATLAB tools) is also used, which allows evaluating the parameters of distribution networks (voltage, current, active, reactive and full capacity) to existing and additional loads. Due to the large amount of data, all information is summarised in Data 3, and then it is used for the analysis of the tests.

The Decision Phase determines approval and the final choice of the distribution network in accordance with the needs of charging stations.

The detailed description of the algorithm methodology, the sequence of the research and the rationale for choosing the methods are available in the sections of the Thesis.

Approbation of the algorithm for studying a low-voltage distribution network in urban and rural areas in accordance with the needs of charging stations has been presented and discussed at scientific conferences and published in proceedings and international scientific journals [22]–[24].

4.2. Description of Algorithm Methodology

Figure 4.2 demonstrates the block scheme of the algorithm of operation of the existing local distribution network in the case of introducing charging stations differentiated by power and charging speed.

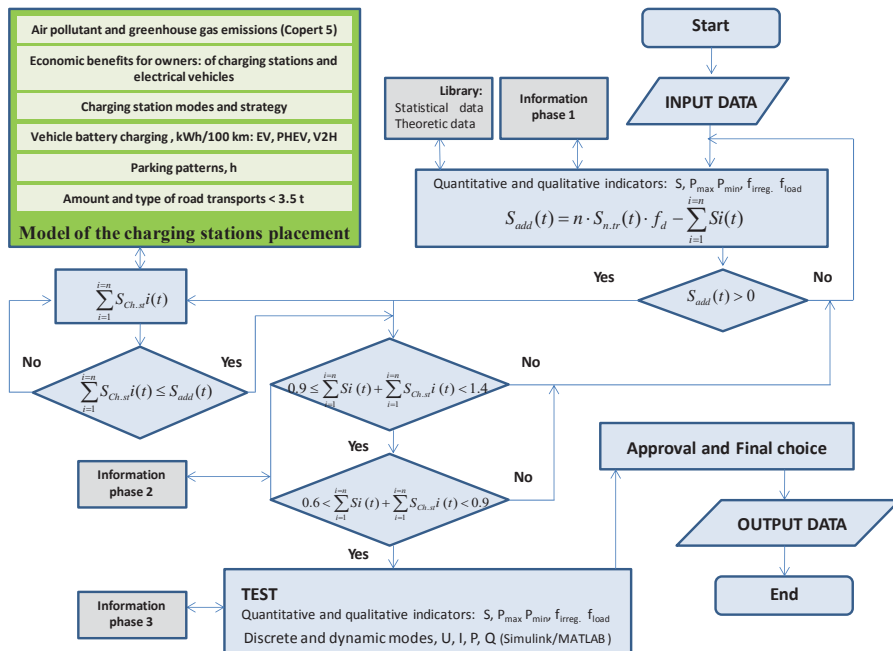

Fig. 4.2. Block scheme of the algorithm.

The working principles of the proposed algorithm are described below.

4.2.1. Stage 1. Selecting the Input Data of the Distribution Network

Since charging stations are considered new consumers, it is necessary to investigate the capabilities of the existing local low-voltage power distribution network and demand of consumers. The distribution network selected for the evaluation should contain as much information about the objects, which have connection to the transformer substation and the plan of territory, as possible. This information can be about the number and type of the objects; the power consumption of the objects and their daily load schedules; the scheme for the distribution network, technical specifications, the number and the location of the transformer substations; length of the streets.

In case of the absence of input data of the power consumption of the objects and their daily load schedules, there is a reference to the Library module (Excel document archive), which contains the database of the quantitative indicators and load graphs of eighteen objects. Quantitative indicators are active power (P , kW), reactive power (Q , kVar), apparent power (S , kVA); coefficients of demand for lift installations of residential buildings (k_d); estimated coefficients of reactive power of residential buildings; specific design of electric loads of public buildings; daily load of consumers of the micro district; parameters of lighting installations of the transport and pedestrian system of streets and roads and the technical specification of three-phase transformers 10/0.4 kV. The missed input data in the Library module are estimated by means of statistical and calculating methods on the basis of mathematical statistics and probability theory [25], [26].

Further, the quantitative indicators and load graphs for each object, transformer substation (TS) and distribution network are calculated. The calculations can be carried out for each season, month and day (working day or weekends) depending on the goals and objectives, and with the presence of input data. For the objects, the calculations take maximum (peak), S_{\max} , average (middle), S_{aver} , minimum (off-peak), S_{\min} , demand and their daily time of use, the load factor (f_{load}) and the irregularity factor (f_{irreg}) [27]–[30].

Then, quantitative and qualitative indicators are generated in the report (in table and graphically) in Information block 1. On the base of this information, the possible additional load for the temporary daily intervals is calculated by Equation (4.1) [31], [32].

$$S_{\text{add}}(t) = 1.4S_{\text{n.tr}}(t) - \sum_{i=1}^{i=n} S_i(t)f_d, \quad (4.1)$$

where $S_{\text{n.tr}}$ – the rated power of the transformer, kVA;

1.4 – the max load factor in the post-fault mode;

S_i – the apparent power of the consumers (objects), kVA;

f_d – diversity factor, ≤ 1 .

If the condition $S_{\text{add}}(t) > 0$ is performed, then the transition to Stage 2 takes place. Otherwise, the algorithm returns to the Input Phase.

4.2.2. Stage 2. Implementation of the Optimal Model for the Placement of Charging Stations

In Stage 2, a stand-alone model of the charging station location is used to study the algorithm methodology. The aim of this model is to satisfy the necessary hourly (daily) requirements for charging electric transport under the conditions of traditional parking places. The interaction of people behaviour, urban infrastructure and the power supply system are used as the main attributes. The model allows estimating the low, medium and high penetration demand for charges. Mathematical statistics methods, probability theory and the simplex mathematical optimisation method for linear programming task have been applied to implement this model.

The model is implemented as follows.

- The input data are represented as data of Stage 1 (S_{add}).
- Number of vehicles with a gross weight of less than 3.5 tonnes and their parking within 24 hours in the area is defined.
- The behavior of car owners at the parking places within 24 hours is reviewed and analysed by cluster analysis.
- Technical indicators: charging types (slow/medium/fast) and the most common models of road electric transport are accepted for the calculations.
- On the basis of the list of road transport, a park of possible electric transport is formed.
- The dynamics of changes in harmful emissions from vehicles under investigation are examined by COPERT 5 program.
- In accordance with the two criteria – the optimal time of the battery charging (the degree of charging is necessary for the owner of vehicles) and the number of charging stations (charging types – slow, medium, fast) at the places of traditional parking – the load necessary for the charging process is estimated (power consumption).
- To provide the best solution during the process, the load is analysed, several options are tested and then the final choice is presented.
- Having received the final version of the location of the infrastructure and the penetration demand (SEVCS is the load of the charging station) for charges, day-night consumption of energy for charging is estimated and compared with $S_{add}(t)$ by using Equation (4.8).

If Equation (4.8) has been performed, the process is completed, and we proceed to Stage 3. Otherwise, the process returns to the point of infrastructure and the penetration demand. It is necessary to calculate a new load of the charging station.

To illustrate the concept of declarative processes, a block scheme of the model is shown in Fig. 4.3.

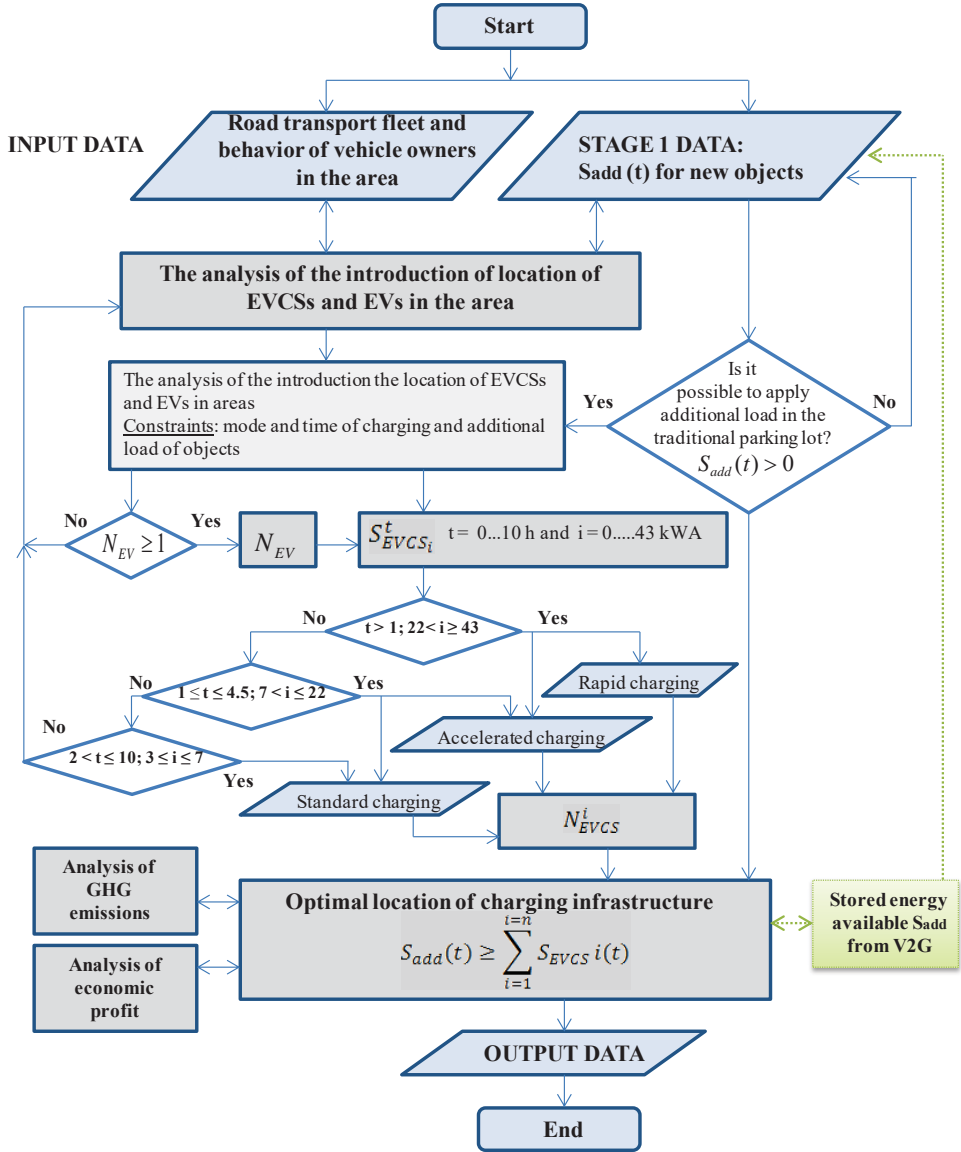

Fig. 4.3. Block scheme of the model of the charging station placement.

4.2.1.1. Description of the Model Methodology

A. Data collection and analysis of interaction of parking pattern in the infrastructure of the area

The analysis of interaction of parking pattern in the infrastructure of the area is based on the collection of input data represented as three groups. The input data of groups are as follows.

Group 1: Stage 1 Data are the condition $S_{add}(t) > 0$.

Group 2: Number of vehicles with a gross weight of less than 3.5 tonnes and location and duration of parking within 24 hours in the area under consideration. Group 2 requires information about behaviour of vehicle owners: number of vehicles, location and duration of parking, and average daily mileage.

Group 3: Process of electric vehicle battery charging. Group 3 requires information about electric vehicles: available EVs and PHEVs in the market and electric vehicle battery charging.

Group 2. Since the fleet of electric vehicles is under formation in Latvia, the input data for modelling are the road vehicles with internal combustion engines. The input data of the number of vehicles are available from the publications of the National Statistical System of Latvia or on the website of the Road Traffic Safety Directorate [20], [33].

To obtain the input data of the location and duration of parking, it is necessary to gather information from different data sources and choose methods for their processing. For the study, the following necessary information has been defined: total number of vehicles in a parking lot (parking lot volume); number of vehicles in a parking lot at a given instant of time (parking accumulation for each hour); annual mileage or the daily mileage of vehicles.

The information has been collected using traditional methods, such as monitoring and studying the existing legislative documents, forms and reports on the location and duration of parking near the house, work, shop, etc. [20], [34], [35]. The information has been processed by the correlation analysis, which is a good analytical technique to group or segment identical elements.

For the analysis, it is necessary to solve the following tasks:

- to estimate the volume of usage and parking demand within 24 hours in the area;
- to choose the most loaded location of parking according to its volume of usage and demand by the correlation analysis;
- to determine average daily mileage.

To estimate the volume of usage and parking demand in the area, a simple average method has been used. Using this method, the total number of parking spaces of each parking lot is calculated and then it is divided by the total number of type units. The formula for the simple average method is as follows (4.2):

$$\bar{X} = \frac{\sum_{i=1}^n X_i}{n}, \quad (4.2)$$

where \bar{X} is sampling mean, n is a set of observations, and X_i is i -sample component.

The level of correlation is analysed using MS Excel program.

The European Environment Agency (EEA) in its Guidebook has adopted standardization for all categories of road vehicles, in particular, for vehicles with a total weight of up to 3.5 tons, such as passenger cars (PCs) and light trucks (LCV) [36]. In the present research, only these two categories are considered since currently there are EVs and PHEVs technologies in this segment.

Further, to continue the study, it is necessary to determine the average daily mileage. For this purpose, the statistics of the average annual mileage for these categories of road transport have been used. These are as follows: average annual mileage for vehicles in the country; in urban and rural areas, and vehicles owned by private persons and by legal persons. The data gathered by the author of the Thesis for the period of 2008–2015 have allowed concluding that the average daily mileage in Latvia has been implemented as follows: the indicator for private persons is 37.7 km per day and for legal persons – 70.4 km per day (the range from 63.8 km to 200 km per day). In Riga, the situation is as follows (as part of the study conducted for Riga City Council): the indicator for private persons is 24.9 km per day (does not exceed 28 km per day) and for legal persons – 71.2 km per day (the range from 57 km to 120 km per day (see Table 3.1) [37], [38].

Group 3. Analysis of EVs and PHEVs availability in the market. To calculate the average power consumption of a single electric vehicle, technical and practical data have been used, which were taken from the following models popular in Latvia: FIAT Fiorino Elettrico, Volkswagen e-up, Nissan e-NV200 Electric Van. Most BEVs cover 100 kilometres with 17 kWh and PHEVs cover 29 kilometres with 7 kWh. The gathered data allowed concluding that the mileage, claimed by the manufacturers, of a fully charged EV might be lower than initially specified. The changes in mileage might occur due to seasonal changes (consequently – road quality changes), the work of the interior electric heater, the influence of low temperatures on the battery, as well as due to the operation of air conditioning, charging of other devices in the car (auxiliary systems of EVs) and, of course, due to the individual manner of driving. As a result, the mileage might become reduced by 30 %. In view of the above, the calculations showed that to cover a distance of 100 km the BEV consumes on an average 24 kWh in winter, 17 kWh in summer, and 21 kWh in spring and autumn.

B. Electric vehicle battery charging

Table 3.1 provides the data of charging times on EVSEs from the database of EV makers. The time of charge and driving range with StEVCS, AcEVCS and RapEVCS charge levels is based on charging an empty battery to full actual state of the charge (SOC_{actual}). From practical point of view, using AcEVCS is the most common and preferred routine for everyday charging. At the same time, RapEVCS is not designed to fill the battery completely but if the vehicle has the long travel during the day, it can drive and have the next charging station [39].

The main characteristics of batteries for EVs are charging time, power demand and the rate of charge [40]. Therefore, the process of charging the battery is carried out in accordance with the selected charging mode (CM), the initial state of charge (SOC_{initial}) and the actual state of the charge (SOC_{actual}) of the battery at the end of the process. In general, a charging action occurs when the SOC level is 15 % or less, because the warning light for the shortage of battery is activated at that level. The communication between EV is determined by ISO 15118, which is designed to support the energy transfer from electric vehicle supply equipment (EVSE) to all types of EVs [41]. Thus, the required state of charge (SOC_{actual}) can be estimated by Equation (4.3).

$$SOC_{\text{actual}} = SOC_{\text{initial}} + SOC(t), \quad (4.3)$$

where $SOC(t)$ is the state of battery charging process at an instant of time, minute or hour. The time depends on the selected mode and power level of the charging station.

Table 4.1

Charging Time on Electric Vehicle Service Equipment

Charge levels	StEVCS, 1.5 kVA AC – 120 V, 15 A	AcEVCS, 6.6 kVA AC – 240 V, 30 A	RapEVCS, 20–120 kVA DC – 400–600 V, up to 300 A
Driving range per hour charge	8 km	36 km	110 km, 270 km
BMW i3 (22 kWh)	15 h	4 h	To 80 %: 24 kW in 30 min
Nissan Leaf (32 kWh)	16 h	5 h	To 80 %: 50 kW in 20 min
Chevy Bolt (60 kWh)	40 h	10 h	To 80 %: 50 kW in 60 min
Tesla S 85 (90 kWh)	60 h	15 h	To 80 %: 120 kW in 40 min

It is important to note that the range of vehicles with electric or hybrid types of engines is expanding every year, so it is impossible to consider the entire spectrum of the existing battery. The technology assessment of BEVs and PHEVs conducted by the California Environmental Protection Agency presented an increase in the average mileage per full charge of the battery by 45 % by the end of 2016 compared to 2010. It is still expected to increase substantially by 2025 [42].

Analysis of the interaction parking pattern in the infrastructure of the area is carried out on the basis of input data and is as follows.

First, the location of parking lots and duration of parking can be estimated in accordance with information about the behaviour of ICE vehicle owners. A passenger car is in motion only a small percentage of the day time. During the remaining time, it is parked near a dwelling house, an office building, and a special parking facility or another convenient place.

The number of observations of parking lots was collected by the author of the Thesis and used as the main reference for estimation of the behaviour of car owners.

Second, the average daily mileage for vehicles in the country has been estimated in accordance with the average annual mileage. Thus, the range is from 24.9 km to 200 km per day.

Third, in accordance with kWh per 100 km of consumption, vehicles can be further classified into three groups (small, medium, large). For each group, the following data are of importance: the maximum charging and maximum time of the charge from an empty battery to a full one. The number of hours required for charging a storage battery using slow charging

(StEVCS) varies from 6 to 12 hours, medium charging (AcEVCS) requires from 1 to 4.5 hours and fast charging (RapEVCS) takes 30 to 55 minutes.

The next stage is to define the placement of charging stations and the load of distribution network. According to the penetration demand and possible additional load, the number of EVs (N_{EV}) is calculated by Equation (4.4).

$$N_{\Sigma EV}^t = \frac{S_{add_i}^t}{S_{EV_i}^t}, \quad (4.4)$$

where $S_{add_i}^t$ is the additional load in the period of time i . The minimum additional load occurs in the winter season, whereas the maximum one – in the summer season.

$S_{EV_i}^t = \sqrt{P_{EV_i}^2 + Q_{EV_i}^2}$ is the load that represents charging for one EV in the period of time.

In calculations $Q_{EV} = 0$ was accepted.

If the condition $N_{EV_i}^t > 0$ is performed, then the transition to the next stage takes place. Otherwise, the algorithm returns to the point of infrastructure and the penetration demand (input data of groups), where it is necessary to calculate a new load of the charging station.

Finally, the results of the analysis of the possible additional load of objects, mode and time of charging station constraints ($S_{EVCS_i}^t$, where $t = 0-10$ h and $i = 0-43$ kVA) and interaction parking pattern in the infrastructure of the area show the parking availability pattern that allows assuming possible scheduling of charging stations. This process is performed by using the IF function in Excel.

The next stage is to define the charging mode and number of charging stations according to the constraints for the public EVCSs. Constraints are classified by EVCS type as follows:

- *Constraint I: $t > 1$ (hour) is period of time interval and $i \geq 43$ (kVA) is the rated input power of charging station. If criteria are performed, this means that in the considered period of time the public RapEVCSs and AcEVCSs can be loaded. If No, then Constraint II shall be used.*
- *Constraint II: $1 \leq t \leq 4.5$ (hour) and $7 < i \leq 22$ (kVA). If criteria are performed, this means that in the considered period of time the public AcEVCSs and StEVCSs can be loaded. If No, then Constraint III shall be used.*
- *Constraint III: $2 < t \leq 10$ (hour) and $3 \leq i \leq 7$ (kVA). If criteria are performed, this means that in the considered period of time the public StEVCSs can be loaded.*

This calculation is also performed by using the IF function that identifies which criteria as a whole are performed and which of the criteria are absent. If the constraints are performed, the algorithm determines the number of public charging stations. Otherwise, the algorithm returns to the analysis of the interaction parking pattern in the infrastructure of the area. To estimate the total number of EVCSs, the three modes of EVCSs (and three cars are connected) simultaneously per hour have been considered. It means that StEVCS (9.7 %) + AcEVCS

(30.6 %) + RapEVCS (59.7 %) = 100 % EVCSs (see Table 4.1). EVCSs represent the load for the main transformer per hour and their total number is defined by Equation (4.5):

$$N_{EVCS} = \frac{9.7 \% S_{add}(t)}{7} + \frac{30.6 \% S_{add}(t)}{22} + \frac{59.7 \% S_{add}(t)}{43} = N_{EVCS_{St}} + N_{EVCS_{Ac}} + N_{EVCS_{Rap}}, \quad (4.5)$$

where $N_{EVCS_{St}}$ is the number of StEVCS, $N_{EVCS_{Ac}}$ is the number of AcEVCS, and $N_{EVCS_{Rap}}$ is the number of RapEVCS.

Equation (4.5) allows determining the total number of stations differentiated by modes. However, the main criterion for choosing and deciding on the number of charging stations is the possible additional load. In the framework of economic expediency, the operation within 24 hours a day and differentiated tariffs for electricity are taken into account for installing public charging stations. The tariffs for electricity for legal persons are differentiated by 3 time zone tariff [43]. In general, all the three modes of EVCSs may be applied to a parking pattern in the infrastructure of the area. Therefore, to determine the specific locations of stations it is necessary to use the optimisation process at this stage, which is solved by the simplex method in Excel Solver [44], [45].

C. Optimisation of placement of charging infrastructure and the ecological and economic aspects

Optimisation of the location of charging infrastructure is carried out on the basis of the data, which were obtained before. Additionally, there are ecological and economic aspects, as well as the opportunity of using the grid-to-vehicle (V2G) / vehicle-to-grid (G2V) technology is considered.

Placement of charging stations based on the simplex algorithm.

The simplex algorithm is a linear mathematical model, which allows finding the optimal or best outcome. The placement problem of charging stations has the following formulation: the location of objects of parking lots (C_1, C_2, \dots, C_n) and the possible additional load of objects (c_1, c_2, \dots, c_n) are known. Three modes of charging stations (B_1, B_2, B_3) and the additional load for EVCSs per hour (b_1, b_2, b_3) are also indicated. Unit load for EVCSs is 7 kVA, 22 kVA, 43 kVA. It is assumed that charging stations are open 24 hours day. Mathematical formulation of linear equations for both the objectives and the constraints are expressed by the following equations.

The objectives:

$$F(x) = b_1x_1 + b_2x_2 + \dots + b_nx_n \rightarrow \max(\min).$$

The constraints:

$$\begin{cases} a_{11}x_1 + a_{12}x_2 + \dots + a_{1n}x_n \leq c_1, \\ a_{21}x_1 + a_{22}x_2 + \dots + a_{2n}x_n \leq c_2, \\ a_{m1}x_1 + a_{m2}x_2 + \dots + a_{mn}x_n \leq c_n, \\ x_j \geq 0; j = \overline{1, N}. \end{cases}$$

Subsequent actions take place in the analysis phase according to Equation (4.6), as well as the transition occurs to the decision phase (Stage 2 Data). Therefore, the total load of charging stations on the local distribution network ($\sum_{i=1}^{i=n} S_{EVCS} i(t)$) is estimated. This load cannot be higher than the additional load in Stage 1, calculated before.

$$\sum_{i=1}^{i=n} S_{EVCS} i(t) = S_{EVCS_{St}}(t)N_{EVCS_{St}} + S_{EVCS_{Ac}}(t)N_{EVCS_{Ac}} + S_{EVCS_{Rap}}(t)N_{EVCS_{Rap}}. \quad (4.6)$$

The location and number of charging stations are provided in Table 4.2.

Table 4.2

Location and Number of Charging Stations

	Parking lot 1	Parking lot 2	...	Parking lot N	Total
StEVCS	×	×	×	×	×
AcEVCS	×	×	×	×	×
RapEVCS	×	×	×	×	×

Analysis of exhaust emissions of motor vehicles based on COPERT 5 Software.

The ecological aspect of this algorithm is the analysis of emissions in urban and rural areas, using the COPERT 5 program reflecting the dynamics of changes in harmful emissions in the structure of road transports. To analyse the possible change of emissions in the use of vehicles with internal combustion engines (ICE) and BEV technologies, the following comparison has been proposed: if the number of ICE technologies is 100 % of the total passenger cars (PCs) and light trucks (LCV) and the number of BEV technologies is more than 50 % (high penetration), less than 10 % (low penetration) and from 10 % to 50 % (medium penetration) of the total passenger cars (PCs) and light trucks (LCV) in the area according to the daily mileage for private persons and legal persons.

COPERT 5 is a software tool used to calculate air pollutant and greenhouse gas emissions from road transport as described in the 2006 IPCC Guidelines and EMEP/EEA Emission Inventory Guidebook – 2016 [46]–[48].

As the basis data for the model, the following information is provided: the number of vehicles, mileage for passenger cars and light-duty trucks, ambient temperature variations during months, and others. Estimation of GHG emissions, air pollutants and effects of cold-start emission is a substantial factor to analyse the change in the emissions in urban and rural areas. COPERT 5 allows determining the fuel consumption for each type of vehicle engine. Chapter 4 of the Doctoral Thesis considers the consumption of primary and secondary energy resources, greenhouse gas emissions and the consumption of electricity in the country until 2030 in the case of widespread use of roads.

Distribution network and vehicle-to-grid / grid-to-vehicle technologies.

The main factors for the implementation of V2G/G2V technologies are the growth of V2G/G2V fleet and use of smart grid technologies to manage commercial and household

loads. Taking into account that the average daily vehicle mileage is used, the power limited by vehicle's (V2G) stored energy is calculated:

$$P_{V2G_{\text{storage}}} = P_{V2G} - P_{\text{as}} - P_{V2G} \frac{l}{100}, \quad (4.7)$$

where P_{V2G} is energy consumption of V2G; kWh per 100 km; P_{as} is auxiliaries service (the consumption for cooling or heating, etc), which according to various sources, on average is 15–30 % of the maximum stored energy; and l is average daily mileage of EV, km.

One V2G battery does not influence the energy supply system. However, if hundred cars are introduced to the system, it can improve the efficiency of power distribution. Available S_{add} from V2Gs will also affect the possible additional load for new objects in the area.

The analysis of economic profit from EV integration

The economic aspect of this algorithm is the interaction and management of needs of the two parties – the driver and the service operator/owner of charging stations. The driver needs electricity in the battery for driving, flexible tariffs for electricity during the day and convenient charging technical solution. The service operator wants the maximum use of charging stations during the day and economic benefits from this business.

Thus, having obtained the optimal location of the infrastructure, the consumption of energy for charging is estimated and compared with $S_{\text{add}}(t)$ using Equation (4.8).

$$S_{\text{add}}(t) \geq \sum_{i=1}^{i=n} S_{\text{EVCS}_i}(t). \quad (4.8)$$

If Equation (3.8) is performed, the algorithm goes to Stage 3. Otherwise, the algorithm returns to the first stage, the input data point of infrastructure and the penetration demand, where it is necessary to calculate a new load of the charging station.

The result of the optimal model for the placement of charging stations is the Decision Phase with output data (Stage 2 Data).

4.2.3. Stage 3. Verification of the Transformer Substation in Post-fault and Normal Modes

During Stage 3, according to the Network Codes and standards, the technical characteristics of transformer substations and equations of Stage 1 are verified during the Calculation Phase and Analysis Phase. Input phase for the Calculation Phase and Analysis Phase is the quantitative indicators of data of Stage 1 and Stage 2. Then, the total capacity of objects with the permissible load of the transformers in the post-fault and normal modes is compared. The post-fault mode is calculated by Equation (4.9).

$$0.9 \leq \sum_{i=1}^{i=n} S_i(t) + \sum_{i=1}^{i=n} S_{\text{EVCS}_i}(t) < 1.4. \quad (4.9)$$

The normal mode is calculated using Equation (4.10).

$$0.5 < \sum_{i=1}^{i=n} S_i(t) + \sum_{i=1}^{i=n} S_{EVCS_i(t)} < 0.9. \quad (4.10)$$

Formation of the calculated data is carried out in the form of a report in the Information block 2. Analysis Phase analyses the report and determines the fulfillment of the conditions (normal and post-fault modes). The final result of Stage 3 is the Decision Phase – identification and application – where the decision is made (Yes) or not made (No). If the conditions are met, go to Stage 4. If at least one of the conditions is not met, further studies are not performed, the algorithm is interrupted (Stop).

4.2.4. Stage 4. Validation of the Algorithm Taking into Account the Specific Location of Electric Vehicle Charging Stations

In the fourth stage, verification of transformer substations and power supply facilities is conducted to ensure that the methodology of the algorithm provides a theoretically reliable result. For Stage 4, the Input Phase is Data 1 of Stage 1 and Data 2 of Stage 3. At the Calculation Phase, quantitative and qualitative indicators for transformer substation are tested according to the following two conditions.

The second test is the assessment of the correct placement of connection at the charging stations with existing objects (reliable operation of electrical network and the absence of emergency situation) and assessment of the efficiency of their use for the power supply scheme under consideration [34], [49].

For this condition, using Simulink Simscape Power Systems (SimPowerSystems) the distribution network is modelled and tested in dynamic mode for parameters such as voltage U , current I , active P and reactive power Q [50]. Simulation of the modes allows for the evaluation of operation of the existing distribution network (voltage, current, active, reactive and apparent power) in accordance with the electric vehicle demands of charging stations and as an element of smart grids.

Data block 3 is used to collect information at the calculation phase and analysis phase. Their data are used for the analysis, as well as in the course of repeated analytical studies.

The final step is the approval and final choice for a local distribution network in accordance with the needs of electric vehicles.

4.3. Algorithm Testing. Effective Urban Electrical Network Infrastructure and the Development of Public EVCSs

4.3.1. Stage 1. Selecting the Network Architecture of Urban Area

To test the algorithm, a residential micro-district in Riga has been chosen, where in the territory of the city district there are 25 transformer substations (TS). In our case, we are interested only in the location of TS-1 (TR 2×1250/10/0.4 kV) in a certain territory that provides electricity for 1656 individual customers. The consumers of TS-1 (TR 2×1250/10 / 0.4 kV) are: 2 office buildings, 4 grocery stores, 12 dwelling houses (three-storey buildings with 12 consumers each), 24 dwelling houses (five-storey buildings with 60 consumers each),

large parking place (for 500 vehicles), 2 catering services, health centre, police department, post office and a kindergarten. The length of the streets is 3.1 km. In the context of the proposed methodology, the quantitative indicators and daily load graphs of the objects and transformer substation have been determined for the working days of all seasons. In order to perform a 24-hour simulation of load curves, the average daily load schedules of electricity consumers have been taken from the library module, which provides information about technical specification of three-phase transformers 10/0.4 kV and load graphs of objects from Latvenergo JSC [51].

The estimation of electricity consumption is performed in the following two steps.

Step 1: A time period of maximum, minimum and average daily electricity consumption for each group of consumers, as well as the load factor and load curve irregularity factor are determined. Due to the fact that consumers have very similar profiles of daily load curve and the same energy consumption tariff plans, it has been decided that the research can be carried out using the general average daily data of the said objects.

Thus, the study is carried out for the average daily data of the winter season. The load in maximum (peak), average and minimum (off-peak) demand periods and its daily time period of use are quantitatively estimated. All factors characterising the electrical load for each consumer obtained in the process of calculation are demonstrated in Table 4.3.

Table 4.3

Factors Characterising the Electrical Load for Consumers

	Household sector			Tertiary sector					
	Dw. house (3-st)	Dw. house (5-st)	Park. lot (for 500 veh.)	Office-indust.	Groc. store	Post office/police depart.	Cater. service	Kinder garten	Health centre
S_{max}, MVA	5.37	16.21	3.24	164.57	83.25	7.39	9.24	7.38	13.61
S_{min}, MVA	8.70	26.27	4.78	221.97	114.69	9.97	12.20	12.25	18.35
$S_{average}, MVA$	3.04	9.18	1.83	111.38	40.76	5.00	4.13	4.00	9.21
f_{load}	0.62	0.62	0.68	0.74	0.73	0.74	0.76	0.60	0.74
$f_{irreg.}$	0.35	0.35	0.38	0.50	0.36	0.50	0.34	0.33	0.50

Further, based on the consumption of objects, the load of the household sector and that of the tertiary sectors have been calculated. The information allows evaluating the largest and smallest load over time intervals. According to the winter graph, time periods for daily schedule are as follows: household sector is characterised by maximum consumption from 7:00 am to 9:00 am and from 5:00 pm to 11:00 pm, minimum consumption takes place from 00:00 am to 6:00 am. The load factor is 0.62. The load curve irregularity factor is 0.35; tertiary sector has maximum consumption from 8:00 am to 8:00 pm, minimum consumption takes place from 9:00 pm to 8:00 am. The load factor is 0.75. The load curve irregularity factor is 0.49. All peaks of the consumption occur between 8 am and 9 am and between 5 pm and 8 pm, and minimum consumption occurs between 00:00 am and 7:00 am. Then, all quantitative and qualitative indicators are generated in Data block 1.

Step 2: Based on the received data, the total load of objects and possible additional load are calculated. The total load of objects per hour can be calculated as follows:

$$\sum_{i=1}^{i=n_c} S_i(t) = n_1 S_1 + n_2 S_2 + n_c S_k, \quad (4.11)$$

where n_c is the number of objects, and S_k is the load of object per hour, kVA.

Calculation results of the total load of objects per hour show that the peak demand is from 7:00 pm to 9:00 pm. The load factor (f_{load}) is 0.81. The irregularity factor ($f_{irreg.}$) is 0.51.

All in all, it can be concluded that the largest load in the urban district is observed from 7:00 am to 11:00 pm, whereas the minimum load is observed from 11:00 pm to 7:00 am.

The possible additional load for 9 objects is estimated for implementation of Stage 2. These 9 objects are chosen to simplify optimisation and reduce the processing time of penetration demand charging data. Taking into account the total load of objects in the urban area and the rated power of the transformers, the possible additional load is calculated for the temporary daily intervals using Equation (4.1).

$$S_{add(t=23:00 \text{ to } 07:00)} = 1.4 \cdot 1250 - 1017.23 \cdot 0.9 = 834.49 \text{ kVA.}$$

$$S_{add(t=23:00 \text{ to } 07:00)} = 1.4 \cdot 1250 - 1459.99 \cdot 0.9 = 436.00 \text{ kVA.}$$

Table 4.4 provides data for the possible additional load per hour, i.e., every hour there is an opportunity to apply additional load.

Table 4.4

Additional Load per Hour (Winter)

	0:00	1:00	2:00	3:00	4:00	5:00	6:00	7:00	8:00	9:00	10:00	11:00	12:00	13:00	14:00	15:00	16:00	17:00	18:00	19:00	20:00	21:00	22:00	23:00
Sadd, kVA	937.24	957.17	1021	1064.7	1085	1079.7	940.44	748.43	614.03	545.73	514.95	523.38	547.75	547.37	538.12	525.01	507.9	510.44	518.34	481.77	436.01	450.7	645.91	834.49

Since condition $S_{add}(t) > 0$ is performed, transition to Stage 2 is carried out at the Decision Phase.

4.3.2. Stage 2. Implementation of the Optimal Model for the Placement of Charging Stations

The input data of groups are as follows:

- Stage 1 Data. Possible additional load on TS-1: $S_{add(t=00:00 \text{ to } 23:00)} = 436.01$ kVA. $S_{add(t=23:00 \text{ to } 07:00)} = 834.49$ kVA and $S_{add(t=07:00 \text{ to } 23:00)} = 436$ kVA. Possible additional load for objects.
- Road transport fleet and behaviour of vehicle owners in the urban district.

Fossil fuel vehicle owners in this urban area are the following: 638 private persons (vehicles that are owned by private persons – residents of the said microdistrict), and 71 legal persons (vehicles that are owned by legal persons – consumers of the said microdistrict

service buildings). The location of public parking lots for vehicles are: 2 office buildings, 4 grocery stores, 12 dwelling houses (3-storey buildings), 24 dwelling houses (5-storey buildings), large parking place (for 500 vehicles), 2 catering services, a health centre, police department, post office and a kindergarten. The parking period near the police department, post office, kindergarten, grocery stores and catering services is restricted to the specified duration (free parking for one hour) due to the limited amount of space near the buildings (the number of parking lots varies from 5 to 10). Therefore, placement of public charging stations in this car parking place is not considered economically viable. Grocery stores and catering services should be economically interested in EVCS location. The charging station powers a car, while its owner is shopping or dining. The parking demand in accordance with the time intervals is presented in Fig. 4.4.

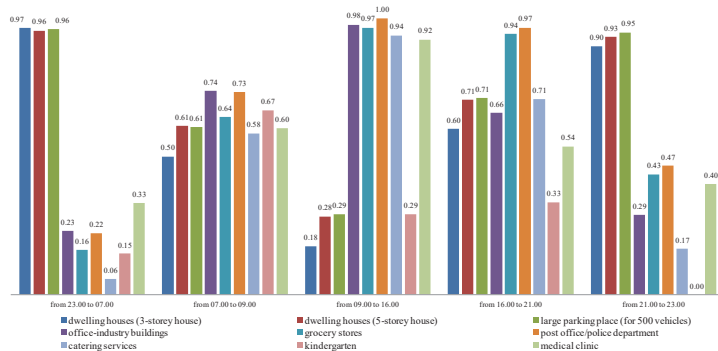

Fig. 4.4. Parking lot demand in accordance with the time intervals.

Car parking near the dwelling houses (3-storey buildings), post office, police department, catering services and kindergarten cannot be recommended as places for public EVCSs, since they have less than 10 parking lots. Hence, the daily mileage of EVs owned by a private person is 24.9 km per day and that by a legal person is 71.2 km per day. Thus, private persons need to charge EVs once two days. Since there is no information about cars of non-resident persons (guest consumers who live and work in another district and charge the vehicles as needed) that could be charged, further calculations will be carried out provided that EVs will be charged every day to cover a distance of 100 km. To obtain the results, it is necessary to define the number of vehicles that could be integrated in the energy distribution network of the said microdistrict on the daily basis, according to the possible additional load.

To reach the above-stated objective, it is assumed that every car has identical battery capacity, $P_{EV_i}^t = 24 \text{ kWh}$ or $S_{EV_i}^t = \sqrt{24^2 + 0^2}$, to get results in similar units.

The number of EVs (N_{EV}) is calculated using Equation (4.4). For example, the minimum additional load occurs at 8:00 pm; consequently, $N_{\Sigma EV}^{20:00} = \frac{436.01}{24} = 18$. Hence, in this urban area 432 of EVs can be integrated per day or 60.9 % of the car fleet.

The obtained results of the parking demand illustrate that condition $N_{EV_i}^t > 0$ is performed and the integration of EVs in a single urban district is as follows:

- from 7.00 am to 9.00 am, the minimum number of EVs is 23;
- from 9.00 am to 4.00 pm, the minimum number of EVs is 21;
- from 4.00 pm to 9.00 pm, the minimum number of EVs is 18;
- from 9.00 pm to 11.00 pm, the minimum number of EVs is 19;
- from 11:00 pm to 7:00 am, the minimum number of EVs is 35.

It is also essential to estimate the additional load of objects, mode and time of charging station constraints ($S_{EVCS_i}^t$, where $t = 0-10$ h and $i = 0-43$ kVA). This process is performed by using the IF function in Excel and has two results of comparison: True or False.

Possible scheduling scheme for the charging station is estimated only for office building, grocery store, dwelling house (5-storey building), large parking place (for 500 vehicles) and health centre.

The results reveal that the constraints $10 \geq t > 10$ and $43 \geq S_i \geq 3$ are performed for all objects, only a large parking lot is the exception from 9:00 pm to 2:00 am (FALSE).

As these objects require a detailed consideration, the next stage is to define the charging mode and number of charging stations according to the constraints for the public EVCSs.

Constraints are as follows.

- *Constraint I: $t > 1$ (h) and $i \geq 43$ (kVA).*
- *Constraint II: $1 \leq t \leq 4.5$ (h) and $7 < i \leq 22$ (kVA).*
- *Constraint III: $2 < t \leq 10$ (h) and $3 \leq i \leq 7$ (kVA).*

Comparison of the constraint results has shown that the charging process will be carried out within 24 hours a day, if the EVCSs is placed in the parking lots as follows.

- Dwelling house (5-storey): standard charging.
- Large parking lot: standard charging can be applied only 18 hours a day, but unavailable during 24 hours.
- Office building: standard charging, accelerated charging and rapid charging.
- Grocery store: standard charging, accelerated charging and rapid charging.
- Health centre: standard charging and accelerated charging.

Thus, constraints are performed only by in objects (a large parking lot does not participate in the subsequent calculations) and now the algorithm determines the number of public charging stations. To estimate the total number of EVCSs, Equation (4.5) is used:

$$N_{EVCS} = \frac{9.7\% \cdot 436.01}{7} + \frac{30.6\% \cdot 436.01}{22} + \frac{59.7\% \cdot 436.01}{43} = 18.$$

Thus, the total number of public charging stations is 18 (6 of each mode). Further testing will be based on the analysis of the interaction parking pattern in the infrastructure of the area,

by using the simplex method in Excel Solver. The following assumptions have justified the implementation of the said method: the functions are linear in nature, parameters are certain, and negative values are unacceptable.

Optimal location of charging infrastructure

The placement problem of charging stations has the following formulation: the location of objects of parking lots (C_1 is a dwelling house (5-storey building), C_2 is an office building, C_3 is a grocery store and C_4 is a health centre) and the possible additional load of objects ($c_1 = 13.13$ kVA, $c_2 = 110.98$ kVA, $c_3 = 57.35$, $c_4 = 9.18$ kVA) are known. Three modes of charging stations (B_1 – StEVCS, B_2 – AcEVCS, B_3 – RapEVCS) and the additional load for EVCSs per hour ($b_1 = 18.53$ kVA, $b_2 = 58.25$ kVA, $b_3 = 113.85$ kVA) are indicated. Unit load for EVCSs is 7 kVA, 22 kVA, 43 kVA. It is assumed that the charging process of high penetration demand is examined. The linear problem has the following formulation for both the objective and the constraints. For a given objective function, the optimisation problem can be written as follows:

$$F(x) = 18.53x_1 + 58.25x_2 + 113.85x_n \rightarrow \max.$$

The constraints:

$$\begin{aligned} 7x_1 + 22x_2 + 43x_3 &\leq 13.13, \\ 7x_1 + 22x_2 + 43x_3 &\leq 110.98, \\ 7x_1 + 22x_2 + 43x_3 &\leq 57.35, \\ 7x_1 + 22x_2 + 43x_3 &\leq 9.18, \\ x_j &\geq 0; j = \overline{1,4}. \end{aligned}$$

Now, it is possible to find the optimal solution using the simplex LP solving method:

The first solution has shown that only the parking place of dwelling house solution satisfies Solver's test for optimality. Therefore, the second test has been performed. It demonstrated that the criteria are satisfied for the other objects under study. To complete the optimal solution properly, the third solution is necessary in order to satisfy all constraints. The data from the first and second solutions have been used. As a result, constraints have been satisfied and an optimal solution has been found. There are no other feasible options. The location and number of public charging stations have been received according to the requirements of the parking of vehicles and allowable additional load on the transformer substation (see Table 4.5).

Table 4.5

The Location and Number of Public Charging Stations

	Parking near a dwelling house	Parking near an office building	Parking near a grocery store	Parking near a health centre	Total
StEVCS	7	–	–	1	8
AcEVCS	–	4	–	–	4
RapEVCS	–	2	4	–	6
					18

Having received the optimal location of the infrastructure, the charging load (the objective function value) is estimated using Equation (4.6).

$$\sum_{i=1}^{i=n} S_{EVCS}(20:00) = 7 \cdot 8 + 22 \cdot 4 + 43 \cdot 6 = 402 \text{ kVA.}$$

Subsequent actions are taken at the analysis phase. The consumption of energy for charging (SEVCS) is estimated and compared with $S_{add}(t)$ using Equation (4.8).

$$436.01(S_{add}) \geq 402.0 \sum_{i=1}^{i=n} S_{EVCS}.$$

Thus, it was revealed that Equation (4.8) is performed, the total load of charging stations is less than the additional load and the test goes to next stage.

Analysis of GHG emissions based on COPERT 5

To analyse the change in the GHG emissions in this urban area, the passenger cars (PCs) and light trucks (LCV) with ICE and EV technologies have been proposed for consideration in the following three scenarios.

- *Scenario 1:* The number of FV technologies is 709 (100 %). Number of vehicles with petrol engine – 400, vehicles with diesel engine – 309.
- *Scenario 2:* The number of FV technologies is 277 (39 %) and the number of EVs is 432 (61 %). The number of EVs has been previously discussed in the Thesis. Number of vehicles with petrol engine – 156, vehicles with diesel engine – 121, battery electric vehicles – 432.
- *Scenario 3:* The number of FV technologies is 509 (71.8 %) and the number of EVs is 200 (28.2 %). The calculation of the number of EVs is shown further. The number of vehicles with petrol engine – 287, vehicles with diesel engine – 222. Number of battery electric vehicles – 200.

Since the minimum number of EVs that can be charged per hour, as well as the number and modes of EVCSs have been defined above, for Scenario 3 NEV per day is defined as follows: 24 (from StEVCS) + 32 (from AcEVCS) + 144 (from RapEVCS) = 200 of EVs.

The daily mileage of EV owned by a private person is 24.9 km per day or 9088.5 km per year and that by a legal person is 71.2 km per day or 25988 km per year.

Comparing the results of the modelled scenarios and the data on the fuel consumption, one can see that Scenario 1 is the most unfavourable as to the control over such fuel consumption and GHGs from the vehicles. Analysis of Scenarios 2 and 3 allows for the conclusion that despite a similar number of transport vehicles it is possible to cut fuel consumption and the volume of relevant emissions by using EVs.

Available S_{add} from V2G technologies

Assuming that V2G technology cars will be used in Scenario 2 and Scenario 3, in the volume of 10 % of the total EVs, V2G/G2V technology has been assessed as the one that can increase the additional load on the electrical network. As such, the average daily vehicle mileage (private and legal persons) is 29.53 km per day, P_{as} is 30 % and battery capacity (24 kWh) has been used to calculate the available S_{add} from V2G by Equation (4.7).

$$P_{V2G_{\text{storage}}} = 24 - 3.6 - 24 \cdot \frac{29.53}{100} = 9.7 \text{ kWh.}$$

As expected, in Scenario 2 the stored energy available S_{add} from V2G is 209.8 kVA and 97.1 kVA in Scenario 3 (S_{add} for new objects, Stage 1 Data). It should be noted that calculation does not include all possible conditions of the electricity transmission back to the grid. Moreover, the car owner of V2G technology can use the stored energy for household needs.

Analysis of economic profit from EV integration

With the help of the electricity tariff system, differentiated by the time of the day, it is possible to stimulate private and legal consumers to participate in the power market. Currently, Latvian households and other users have the opportunity to use a two-tariff system and a three-tariff system that include the use of tariffs according to the time of the day. Based on consumers' response to day-time pricing, consumers can be classified as EV consumers and EVCS consumers. The electricity distribution differential tariffs (without VAT) have been applied in calculations [52].

Assuming that these rates are used by the EV consumers, owners of BEV and V2G technology, the cost of a single charge per 100 km is as follows.

- Two-tariff system, in the case of charging:
 - night zone and weekends (11:00 pm to 7:00 am) – 0.90 EUR;
 - day zone (7:00 am to 11:00 pm) – 1.34 EUR.
- Three-tariff system, in the case of charging:

- maximum hour zone (8:00 am to 10:00 am, and 5:00 pm to 8:00 pm) – 3.10 EUR;
- day zone (7:00 am to 8:00 am, 10:00 am to 5:00 pm, 8:00 pm to 11:00 pm) – 2.75 EUR;
- night zone and weekends (11:00 pm to 7:00 am) – 2.57 EUR.

During the day, taking into account the average mileage of the car, the owner of V2G technology contributes to the network 9.7 kWh, while receiving an income of 0.39 EUR (where 1 kWh = 0.04 EUR/kWh). If, these rates are used by the EVCS consumers, for example, public rapid charging stations at parking lots near office buildings, it will be difficult to evaluate the revenue from one EV because this refers to economic and business studies. Thus, the result of Stage 2 is the output data on the load of charging stations, their location, type and quantity in urban area (see Table 4.6), and further testing proceeds to Stage 3.

Table 4.6

Output Data of Stage 2

	Number of EVCSs	SEVCS, kVA*
StEVCS	8	56
AcEVCS	4	88
RapEVCS	6	258
Total	18	402

*Minimum additional load occurs at 8:00 pm.

4.3.3. Stage 3. Verification of TS-1 in Post-fault and Normal Modes

During the third stage, the total load of objects with permissible load of transformers in post-fault and normal modes is compared.

Pst-fault mode: $0.9 \leq 1.34 < 1.4$,

Normal mode: $0.5 < 0.67 < 0.9$.

As the conditions are met, we proceed to Stage 4.

4.3.4. Stage 4. Validation of the Algorithm Taking into account the Specific Location of Electric Vehicle Charging Stations

At the fourth stage, the quantitative and qualitative indicators for transformer substation are tested according to the two conditions. The data blocks 1 and 2 are used as input data.

To fulfil the first condition, the calculation process of Stage 1 of this algorithm (the parameters and coefficients of the local distribution network are calculated) is used. At the Decision Phase of output data (data of Stage 2), the location of public charging stations has been completed, and it has been revealed that the public charging stations can be located at parking lots near a dwelling house, office building, grocery store and a health centre. For these objects, as well as for the transformer substation the parameters and coefficients have been calculated. Further, all quantitative and qualitative indicators are generated in data

block 3. Thus, by just using charging load of EVCSs, the parameters and coefficients have improved.

f_{load} :

- for dwelling houses (5-storey building) from 0.620 to 0.621;
- for office buildings from 0.74 to 0.78;
- for grocery stores from 0.73 to 0.75;
- for health centre from 0.74 to 0.81;
- TS-1 from 0.81 to 0.85.

f_{irreg} :

- for dwelling houses (5-storey building) from 0.35 to 0.36;
- for office buildings from 0.50 to 0.58;
- for grocery stores from 0.36 to 0.41;
- for health centre from 0.50 to 0.64;
- TS-1 from 0.51 to 0.61.

The results show that the extent of the transformer substation power use and factors that characterise the load objects increase, implying an increase in the reliability and effectiveness of the network as such. Before carrying out the second condition, the urban distribution network is modelled, using Simulink Simscape Power Systems (SimPowerSystems). Thus, to validate the algorithm, two work modes have been simulated.

- Work mode A is a model of the existing urban local network.
- Work mode B is a model of the same network with added charging stations at parking lots.

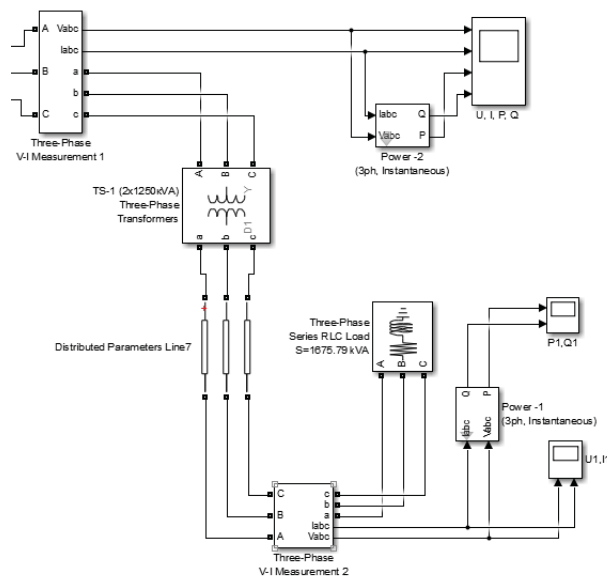

Fig. 3.5. Reference network model (part: the substation buses of 10/0.4kV, Work mode B).

Figure 3.5 shows the test system for the substation buses of 10/0.4kV, where the local network model includes the local charging infrastructure. Comparison of the test results without and with charging stations has shown that while creating a charging infrastructure in the urban district, the total load for TS-1 increases by 14.8 %, which does not exceed the maximum permissible values for a transformer substation TR 2×1250/10/0.4 kV. For the substation buses the process of changes in all three phases happens at present within the margins of 11.59–13.34 % (there is an increase) and voltage within the margins of 0.04–0.16 % (there is a decrease).

The results of the analysis of the two work modes have the following features.

- The quantitative and qualitative factors that characterise the distribution network load increase, imply an increase in the reliability and effectiveness of the network as such.
- The possible additional load exceeds the total demand of charging stations in the area. Consequently, this load does not lead to network overloads, does not affect the quality of power and does not require the replacement of the transformer substation TS-1.
- The obtained test results illustrate that standard charging stations account for 44.5 % of the total number of charging stations, accelerated charging stations make up 22.2 %, and rapid charging stations – 33.3 %. At high EVs penetration, when the operating of all EVCSs happens within 24 hours a day, the average daily electricity consumption is increased by 14.8 %.

Stage 4 of this algorithm confirms the compliance with reliability requirements of power supply to the local distribution network in accordance with the Latvian and European quality standards. Testing allows concluding that the methodology of the algorithm results in the acquisition of theoretically valid results.

5. ANALYSIS AND DEVELOPMENT OF LONG-TERM FORECAST OF ENERGY CONSUMPTION IN LATVIA BY 2030

5.1. Modelling Framework and Scenarios

The starting point for the modelling of forecast is the following main indicators: the existing and future energy system of Latvia (including energy and environmental policy); energy consumption and energy resources structure by national economy sectors (including the quantities and costs of primary and secondary energy resources, the technologies of energy and emission reduction); macroeconomic indicators for the past period, from 1990 to 2016, and the country's expected economic development data up to 2030 (gross domestic product (GDP), development of national economy (surplus value), living standards (consumption or expenditure by households, including personal expenditure forecasts), and demographic development of population, etc. It is important to note that the actual calculation of the Latvian emissions and the dynamics of the development of road transport in MARKAL-LV model are made using the COPERT 5 model. Fuel consumption, average mileage and emission simulation for all types of engines are simulated in COPERT 5 model, taking into account tighter emission European standards and emission degradation due to catalyst wear, as well as the emission effects of hot, cold-start and evaporation. The main indicators are included: the passenger kilometres per year; average mileage per vehicle a year; total mileage of vehicles a year (types of vehicles: passenger cars, light-duty vehicles (LDV < 3.5 tonnes), buses, heavy-duty vehicles (HDV > 3.5 tonnes)), freight tonne kilometres (LDV and HDV) of vehicles a year. The electric motorcycles and mopeds are not included in the modelling because there is a lack of technical and economic data. The starting information for the fuel consumption calculation of BEVs and PHEVs is the data presented in the reports and studies [53]–[56]. The historical and projected trends from 2015 to 2030 for the BEV and PHEV technologies accepted for the present research are shown in Table 5.1. Thus, the starting point for the two scenarios assumes the existing national policies of Latvia as well as energy and climate targets for 2020 and 2030. Both scenarios have been proven.

- *Scenario 1. BASE scenario* assumes the targets, which are focused on current situation in the branches of economy and their development trends. The vehicle fleet starts to shift to plug-in hybrid electric vehicles (petrol and diesel) and battery electric vehicles after 2020 without specific supporting policies. The ratio of battery electric vehicles and plug-in hybrid electric vehicles (petrol and diesel) is assumed as follows: 0.07 % in 2020, 0.4 % in 2025, and 2.15 % in 2030 of the total road transport fleet. Thus, in comparison with 2015, the total number of BEV and PHEV technologies will increase 2.4 times in 2020, 13.5 times in 2025, and 75.1 times in 2030.
- *Scenario 2. EV_Strategy scenario* assumes the targets, where the subsequent formation of road transport is based on electric vehicles of at least 160 000 (20 %) by 2030. The rate of change gets bigger sharply from 2025 to 2030, reaching the share of 15.5 % of EVs and 0.045 % of PHEVs by 2030 of the total road transport park.

However, the total share of EVs is 0.27 % in 2020, 2.85 % in 2025, and 20 % in 2030 of the total road transport fleet.

Table 5.1

Historical and Projected Trends in the Road Transport Sector

Year		Small pass.cars	Medium pass.cars	Large pass.cars	LDV/HDV/ buses
	Electrical energy stored in batteries	9–12 kWh	12–18 kWh	18–34 kWh	24–180 kWh
2015–2030	BEV Electricity, %	100	100	100	100
	PHEV				
2015	Electricity/Petrol or Diesel, %*	25/75	35/65	45/55	35/65
2020	Electricity/Petrol or Diesel, %*	30/70	40/60	50/50	40/60
2025	Electricity/Petrol or Diesel, %*	35/65	45/55	55/45	45/55
2030	Electricity/Petrol or Diesel, %*	40/60	50/50	60/40	50/50

*Consumption of electricity and fossil fuels in percentage.

5.2. Analysis and Comparison of the Results

The development of the fleet of electric vehicles and infrastructure for their charging are the solutions to reduce greenhouse gas emissions in the country, which have been considered within the framework of two scenarios.

Baseline scenario is based on the actual situation of energy system of Latvia and the electric vehicle fleet development trends for 2030. Therefore, this is taken as the starting point for comparison. The Strategic scenario is based on the same development of energy system of Latvia, but assuming that 20 % of the road transport fleet will be electric vehicles. This can be achieved using aggregate measures, such as motivation for buying electric vehicles and creating of affordable infrastructure and charging networks. Comparing the data given in the scenarios for the number of EVs, the author of the Thesis has obtained the following results.

- **2020:** in EV_STR scenario, the number of BEVs is 4 times bigger and that of PHEVs is 2.2 times bigger than in the BASE scenario.
- **2025:** in EV_STR scenario, the number of BEVs is 7.9 times bigger and that of PHEVs is 4.5 times bigger than in the BASE scenario.
- **2030:** in EV_STR scenario, the number of BEVs is 8.9 times bigger and that of PHEVs is 10.6 times bigger than in the BASE scenario.

In EV_STR scenario, the structure of vehicles is characterised not only by higher share of BEVs and PHEVs, but also by the difference in use of PHEV technologies in comparison with the BASE scenario. If in the BASE scenario PHEVs that use petrol dominate, 19 % of PHEVs using petrol, and 1 % of PHEVs using diesel, whereas in case of EV_STR scenario PHEVs that use diesel fuel dominate, 9 % of PHEVs using petrol and 13 % of PHEVs using diesel.

Comparing the results of the consumption of electricity by road transport during the 15-year period, in case of EV_STR scenario the consumption will grow substantially, more than 12 times, as compared with the BASE scenario. This difference is due to the structure of road

transport fleet; mainly the share of EVs is used in scenarios. The total consumption of electricity in EV_STR scenario is higher by 0.00058 % (0.013 PJ) in 2020 than in the BASE scenario, and by 5.3 % (1.4 PJ) in 2030. The modelling results reveal that the total greenhouse gas emissions and GHG emissions from the road transport in both scenarios indicate a decrease in 2030 with respect to 2005 (Fig. 5.1). However, comparing the EV_STR scenario with BASE scenario it has been found that the total greenhouse gas emissions are reduced by 0.7 %, but in the road transport sector – by 0.27 % in 2020; and by 0.42 % and 1.86 % in 2025, and by 4.59 % and 13.65 % in 2030, respectively.

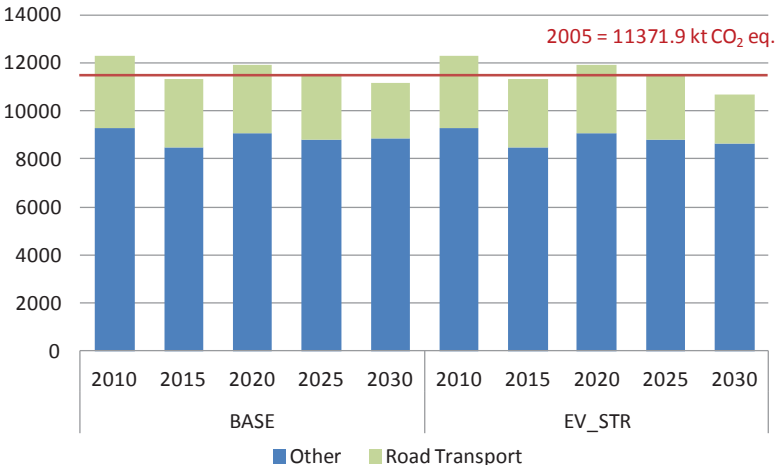

Fig. 5.1. Comparison of GHG emissions by two scenarios, 2010–2030, kt CO₂ eq.

The comparison of the two scenarios with respect to 2005 allows to conclude the following.

- In 2020, the BASE scenario includes an increase in the consumption of fossil fuels by 3.30 % and an increase in GHG emissions by 5.02 %.
- In 2030, in the BASE scenario there will be a 23.49 % decrease in fossil fuel consumption, and GHG emissions will reduce by 1.80 %.
- In 2020, the EV_STR scenario includes an increase in the consumption of fossil fuels by 3.26 % and an increase in GHG emissions by 4.18 %.
- In 2030, in the EV_STR the fossil fuel consumption will reduce by 27.19 % and GHG emissions will reduce by 9.69 %.

Comparing the results of the modelled scenarios, it can be observed that the EV_STR scenario is the most suitable one for fulfilling the tasks of the national targets for 2020 and 2030, as it allows achieving 9.69 % below 2005 level by 2030, whereas the BASE scenario – only 1.8 %.

CONCLUSIONS

The research has shown that to implement the Latvian National Development Plan it is necessary to pay special attention to the road transport sub-sector, where during many years the annual increase in energy consumption and greenhouse gas emissions has been observed. Thus, the investigation of the potential for the development of a fleet of vehicles with engines working on alternative fuels (cars with hybrid engines, clean electric motors, etc.) is of critical importance in promoting the decrease in consumption of fossil fuels and in retaining the growth of GHG emissions.

The analysis of road transport fleet has revealed that the growing demand for electric vehicles in Latvia and worldwide is currently triggered by government incentives, including subsidies, exemptions from tolls and parking fees.

Moreover, despite the increased attention to the development of infrastructure of charging stations, in Latvia a number of theoretical and practical issues remain unresolved, which is explained by the lack of real practical data on electricity consumption of cars and mileage per charge. This also related to the study of low-voltage distribution networks in the context of their interaction with electrical vehicle charging stations (as new electricity consumers).

The analysis of seasonal and daily energy consumption of several household and service sector objects with installed charging stations, as well as an estimation of possible tariffs differentiated by the time of the day has indicated that with the help of the electricity tariff system it is possible to stimulate the private and legal consumers to participate in the power market. Owners of buildings (objects) that will provide the services of charging stations from their distribution network may receive economic benefits.

For this purpose, several factors should be considered: estimation of equipment cost of charging stations, its proper installation into the local network, and an accurate study of possible economic profit from such an investment into the energy trading business.

Within the framework of the present research, the structure of the algorithm of a local distribution network in accordance with the needs of electric vehicle charging stations has been considered and tested. At all the four stages, the specific tasks have been solved and implemented. For completeness and accuracy studies, the algorithm is presented together with a test case.

The result testing allows concluding that the methodology of the algorithm leads to the acquisition of theoretically valid results.

The proposed algorithm allows investigating the local distribution network of a residential area and obtaining the optimal solution for creating infrastructure on its territory of district, in accordance with the requirements of residents (owners of electric vehicles) simultaneously ensuring the reliability of the power supply network in the urban or rural area.

Analysis of a long-term forecast of energy consumption in Latvia till 2030 indicates that the current trend of development of the country shows good performance to meet its national targets in the energy sector. The strategic scenario has considered preconditions that could accelerate the use of electric vehicles, which is a positive sign in the future. The results of the scenario allow concluding that it is possible to decrease the fossil fuel consumption and the

GHG emissions owing to the use of efficient electric vehicles, despite the expected increase of road transport fleet. If the strategic scenario is implemented, the national obligations will be achieved by 2030.

FURTHER RESEARCH

The present research has revealed several opportunities for further research.

First, the new algorithm described in the research should be adapted to the existing distribution network and planning tools for its application in the future.

Second, it is necessary to create blocks where a smart tariff plan controls the charging of an electric vehicle within 24 hours. This will make it possible to theoretically estimate the charging at any time, and offer charging at the time when the consumer demand for electricity in the network is low. Smart tariff plan will reduce the cost of payment by EV owners, will control other charging sites located in the area and reduce the demand for electricity at peak times, thus ensuring flexibility, stability and reliability of the distribution network operation.

Third, in further studies it is planned to create a new block, where generation from renewable energy sources (such as solar, wind energy, and others) will be calculated and taken into account when estimating additional capacity in the area.

Fourth, the algorithm considers only three basic criteria, such as the vehicle owners' behaviour, urban infrastructure and the power supply system. In further research this algorithm can be expanded with more additional factors and criteria to improve real-time applicability situations.

The author is more than happy to support or take part in further research with interested parties.

REFERENCES

- [1] BP Statistical Review of World Energy June 2017. 52 p. Available: <https://www.bp.com/content/dam/bp/en/corporate/pdf/energy-economics/statistical-review-2017/bp-statistical-review-of-world-energy-2017-full-report.pdf>.
- [2] Latvia's National Inventory Report. Submission under UNFCCC and the Kyoto Protocol. Common Reporting Formats (CRF). 1990–2016. 2018, 492 p.
- [3] Eiropas Komisijas paziņojums Eiropas Parlamentam, padomei un Eiropas ekonomikas un sociālo lietu komitejai. Eiropas tīru un energoefektīvu transportlīdzekļu stratēģija. Briselē, 28.4.2010, 15.lpp.
- [4] BP Statistical Review of World Energy – underpinning data 1965-2016. Available: <https://www.bp.com/en/global/corporate/energy-economics/statistical-review-of-world-energy.html>
- [5] Centrālā statistikas pārvalde. (Central Statistical Bureau). Statistikas datubāze. Energobilace. Available: <http://www.csb.gov.lv/en>.
- [6] 2020 climate & energy package. Available: https://ec.europa.eu/clima/policies/strategies/2020_en.
- [7] 2030 climate & energy framework. Available: https://ec.europa.eu/clima/policies/strategies/2030_en#tab-0-0.
- [8] Latvijas Nacionālajā attīstības plānā 2014.-2020.gadam. Rīgā 2012.gada 20.decembrī. “Latvijas Vēstnesis”, 6 (4812), 09.01.2013. OP numurs: 2013/6.11. 45.lpp.
- [9] Eiropas Komisijas 03.03.2010. paziņojuma “Eiropa 2020” Stratēģija gudrai, ilgtspējīgai un integrējošai izaugsmei” COM(2010) 2020 galīgā redakcija. 35.lpp.
- [10] EnergyPlan. Global and International Energy System Tools. Available: www.energyplan.eu/othertools/global
- [11] Klavs, G., Kudrenickis, I., Reķis, J. Development of Latvia Greenhouse Gas Reduction Policy: Modelling and Analysis. *15th International Multidisciplinary Scientific GeoConference SGEM*, resort Albena, Bulgaria. Conference Proceedings, ISBN 978-619-7105-38-4, ISSN 1314-2704, Book 4, 2015, pp. 921–932.
- [12] Global EV outlook 2017. Two million and counting. © OECD/IEA 2017.
- [13] Statista. The Statistics Portal. Available: <http://www.statista.com/statistics/270603/worldwide-number-of-hybrid-and-electric-vehicles-since-2009/>.
- [14] Chargemap. Statistics about charge points. Available: <https://chargemap.com/stats>.
- [15] International Organization for Standardization (ISO). Road vehicles - Vehicle to grid communication interface -- Part 1: General information and use-case definition. ISO 15118-1:2013. Technical Committee: ISO/TC 22/SC 31, ICS: 43.120: Geneva, Switzerland, 2013, 65 p. <https://www.iso.org/standard/55365.html> (2013).
- [16] International Organization for Standardization (ISO). Road Vehicles—Vehicle-to-Grid Communication Interface—Part 2: Network and Application Protocol Requirements; ISO 15118-2:2014; Technical Committee: ISO/TC 22/SC 31, ICS: 43.120 Electric road vehicles: Geneva, Switzerland, 342 p., <https://www.iso.org/standard/55366.html> (2014).
- [17] The International Electrotechnical Commission (IEC). Electric Vehicle Conductive Charging System. Part 1: General Requirement, IEC 61851-1:2010, ISBN 978-2-88912-222-6, 99 p., 2010.
- [18] 18 Ministry of Environmental Protection and Regional Development of the Republic of Latvia. Open tender of Climate Change Financial Instrument. Available: http://www.varam.gov.lv/lat/darbibas_veidi/KPFI/projekti/?doc=17817.
- [19] Latvenergo. Uzlādes punktu karte. Available: https://www.latvenergo.lv/lat/iepirkumi_konkursi_piedavajumi/e_transporta_uzlades_punktu_kart.
- [20] Road Traffic Safety Directorate of the Republic of Latvia (CSDD). Available: <http://www.e-transportos.org/index.php/tutorials-menu-48>.

- [21] Rubenis, A., Berjoza, D., Grīslis, A., Francis, I. Latvijas nacionālā elektrotransportlīdzekļu uzlādes tīkla izveidošanas analīze. Rīga, 2016. 70 lpp. Available: <http://www.tf.llu.lv/getfile.php?id=5315>.
- [22] Grackova, L., Oleinikova, I., Klavs, G. Modelling the location of charging infrastructure for electric vehicles in urban areas. The 17th International Multi-Conference. Reliability and Statistics in Transportation and Communication (RelStat'17). Transport and Telecommunication Institute. 18–21 October, Riga, Latvia, 2017.
- [23] Grackova, L., Zhiravetska, A., Oleinikova, I., Klavs, G. Aspects of effective urban electrical network infrastructure development for the introduction of electric vehicles charging stations. *58th International Scientific Conference on Power and Electrical Engineering of Riga Technical University (RTUCON)* Riga & Mezotne, Latvia, 12–13 October, 2017.
- [24] Grackova, L., Oleinikova, I., Klavs, G. Algorithm-based analysis for the charging stations impact evaluation on the low-voltage distribution networks. *Proceedings of the 9th International Scientific Symposium on Electrical Power Engineering*. ELEKTROENERGETIKA 2015, 12–14 September, 2017, Stara Lesna, Slovak Republic. pp. 580–584.
- [25] Kholyanov, V., Kholyanova, O. The power supply of non-industrial objects: Study guide. Vladivostok. 2007, 121 p.
- [26] Vanags, A. Electrical networks and systems. Part I. Riga. Petergailis, 1995, 438 p.
- [27] Watkins, G. P. (1915). “A Third Factor in the Variation of Productivity: The Load Factor”. *American Economic Review* (American Economic Association) 5 (4): 753–786. Retrieved December 5, 2012.
- [28] Fedorov, A. A. Basics of power supply of industrial enterprises. M.: Energia, 1972, 416 p.
- [29] The load consumption database. Available: www.latvenergo.lv/portal/page/portal/Latvian/Sad_tikls/Tipveida+grafiki_jauns.htm.
- [30] H.Markiewicz, A. Klajn. Power Quality Application Guide. Voltage Disturbances Standard EN 50160. Copper Development Association. United Kingdom. 2004. p.16. <http://www.cdtechnics.be/542-standard-en-50160-voltage-characteristics-in.pdf>
- [31] Latvijas energostandarts LEK-139 “Prasības 1 kV elektrotīkla projektēšanai un būvniecībai”. Latvijas Elektrotehniskā komisija (LEK). 2. izdevums, Reģistrācijas nr. 183. Datums: 22.04.2013, Rīga, 37 lpp.
- [32] Latvenergo AS. Existing and possible Latvian Electrotechnical Commission's energy standards. Available: http://www.latvenergo.lv/lat/par_mums/normativie_dokumenti/lek_energostandarti/
- [33] Centrālā statistikas pārvalde (CSP). Datubāze. Transports un tūrisms. Available: <http://www.csb.gov.lv/dati/statistikas-datubazes-28270.html>.
- [34] Bill Brown, P.E., Square D Engineering Services. Section 3: Load Planning. Available: http://static.schneider-electric.us/assets/consultingengineer/appguedoc/section3_0307.pdf.
- [35] Rigas satiksme. www.rigassatiksme.lv/en/services/parking-services/parking-services/.
- [36] EMEP/EEA air pollutant emission inventory guidebook. Road transport. 30.09.2016., 153 p. <https://www.eea.europa.eu/publications/emep-eea-guidebook-2016> (2016).
- [37] “Tiešo un netiešo SEG emisiju aprēķinu veikšana transporta sektorā par 2016. gadu un pārrēķinu sagatavošana par 1990.–2015. gadu un SEG prognožu sagatavošana enerģētikas, transporta, rūpniecisko procesu sektoros”. VARAM, 2017.
- [38] Riga Smart City sustainable Energy Action Plan for 2014–2020. Decision 1358. 131 p., Available: http://www.rea.riga.lv/files/RIGA_SMART_CITY_SEAP_2014-2020_EN.pdf (2014).
- [39] International Organization for Standardization (ISO). Road vehicles – Vehicle to grid communication interface – Part 1: General information and use-case definition. ISO 15118-1:2013. Technical Committee: ISO/TC 22/SC 31, ICS: 43.120: Geneva, Switzerland, 2013, 65 p. Available: <https://www.iso.org/standard/55365.html> (2013).
- [40] International Organization for Standardization (ISO). Road Vehicles – Vehicle-to-Grid Communication Interface – Part 2: Network and Application Protocol Requirements; ISO 15118-2:2014; Technical Committee: ISO/TC 22/SC 31, ICS: 43.120 Electric road vehicles: Geneva, Switzerland, 342 p. Available: <https://www.iso.org/standard/55366.html> (2014).

- [41] The International Electrotechnical Commission (IEC). Electric Vehicle Conductive Charging System. Part 1: General Requirement; IEC 61851-1:2010; ISBN 978-2-88912-222-6, 99 p., 2010.
- [42] California's Advanced Clean Cars Midterm. Review Appendix C: Zero Emission Vehicle and Plug-in Hybrid Electric Vehicle Technology Assessment. California Environmental Protection Agency. Air Resources Board. January 18, 94 p., 2017.
- [43] AS Sadales tikls. Rates. 2018. Available: www.sadalestikls.lv.
- [44] Innokenti V. Semoushin. Linear Programming: Computer Interactive Course. Shake Verlag, 2002, 125 p.
- [45] Акулич, И.И. Математическое программирование в примерах и задачах /И.И. Акулич. – М. : Высшая школа, 1986. – 317 с.
- [46] EMISIA SA.COPERT 5. Available: <http://emisia.com/products/copert/copert-5>.
- [47] 2006 IPCC Guidelines for National Greenhouse Gas Inventories. Available: <https://www.ipcc-nggip.iges.or.jp/public/2006gl/>.
- [48] EMEP/EEA air pollutant emission inventory guidebook – 2016. 30 Sep 2016. Available: <https://www.eea.europa.eu/themes/air/emep-eea-air-pollutant-emission-inventory-guidebook>.
- [49] Lucas, F. Bonavitacola, E. Kotsakis, G. Fulli. Grid harmonic impact of multiple electric vehicle fast charging. Electric Power Systems Research. Volume 127, October 2015, 13–21 pp. Available: http://ac.els-cdn.com/S0378779615001534/1-s2.0-S0378779615001534-main.pdf?_tid=330fb8e4-1c3a-11e6-8013-00000aacb361&acdnat=1463494877_254e955275b0e8ee5ab80c51c0182ff6a.
- [50] MathWorks. Simulink Simscape Power Systems (SimPowerSystems). Available: <https://uk.mathworks.com/products/simpower.html>.
- [51] Available Latvian Transmission System Operator web site: http://www.ast.lv/eng/power_system/current_situation_in_power_system/planned_and_actual_demand_net_exchange_and_production/.
- [52] Sadales tikls AS. Electricity traders for legal entities. 2018. Available: <https://www.sadalestikls.lv/tarifi/speka-esosie-tarifi/>.
- [53] Simoes, S., Nijs, W., Ruiz, P., Sgobbi, A., Radu, D., Bolat, P., Thiel, C., Peteves, S. The JRC-EU-TIMES model – Assessing the long-term role of the SET Plan energy technologies. Luxembourg: Publications Office of the European Union. 2013, 376 pp.
- [54] Clean Technica. 2018. Available: <https://cleantechnica.com/>.
- [55] Plugin Cars. 2018. Available: <http://www.plugincars.com/>.
- [56] 2017 Government GHG conversion factors for company reporting. Methodology Paper for Emission Factors – Final Report. August 2017, 138 p. Available: https://assets.publishing.service.gov.uk/government/uploads/system/uploads/attachment_data/file/650244/2017_methodology_paper_FINAL_MASTER.pdf.



Larisa Grackova was born in 1966, in Riga. She received the M.Sc. degree in Electrical Engineering from Riga Technical University in 1989. She is a researcher of the Institute of Physical Energetics. Her research areas are energy consumption and supply database in Latvia, simulation of energy systems and energy policy, simulation of fuel and emissions of road transport sector, and impact of electric vehicles on distribution network infrastructure.